



U.S. Department
of Transportation
**National Highway
Traffic Safety
Administration**



DOT HS 811 529

December 2011

FATALITY ANALYSIS REPORTING SYSTEM (FARS)

Analytical Users Manual 1975-2010

FARS Analytic Reference Guide

1975 – 2010

U. S. Department of Transportation
National Highway Traffic Safety Administration
National Center for Statistics and Analysis
Washington, D.C. 20590

Table of Contents

2010 FARS/NASS GES Standardization.....	2
New in 2010 FARS	4
Variables with Changes in Definitions and Attributes	5
New SAS Tables in 2010.....	32
Summary of the SAS Naming Changes in 2010	39
Trafficway Descriptor Data Elements 2010.....	41
Preface	43
FARS Operations.....	44
FARS Instructions	45
FARS SAS Data Sets.....	46
FARS Variable List.....	49
Variable Definitions and Codes	59
The ACCIDENT Data Set	64
The VEHICLE Data Set.....	115
The PERSON Data Set	251
The CEVENT Data Set.....	299
The VEVENT Data Set.....	306
The VSOE Data Set	313
The FACTOR Data Set.....	317
The VIOLATN Data Set.....	319
The VISION Data Set	323
The MANEUVER Data Set	325
The DISTRACT Data Set.....	327
The DRIMPAIR Data Set.....	329
The NMIMPAIR Data Set.....	331
The NMCRAASH Data Set	333
The NMPRIOR Data Set	335
The SAFETYEQ Data Set	337
The PARKWORK Data Set.....	339
The PBTYPY Data Set	411
Appendices	435
Appendix A: Vehicle Make/Model Designation	436
Appendix B: V23 Accident Type Diagram.....	511
Appendix C: Additional Variable Information	512
Appendix D: FARS Variables by SAS Table and Year	542

2010 FARS/NASS GES Standardization

The purpose of this document is to inform users of NHTSA's Fatality Analysis Reporting System (FARS) and National Automotive Sampling System General Estimates System (NASS GES) data about some of the more significant changes to the 2010 data as a result of the standardization of the data elements between the two systems. In addition to the changes outlined below, a listing of all specific data element changes can be found in the following table:

[Variables with Changes in Definitions and Attributes](#)

The FARS/NASS GES Standardization began in 2006, with the second phase being implemented in the 2010 data collection year. The definition and element attribute changes introduced in 2010 are the most substantive and most numerous changes in one year in the reconciliation of the FARS and NASS GES data systems. In the 2011 data collection year – the third and final planned phase of the FARS/NASS GES Standardization – nearly all remaining data element attribute and file structure differences will be addressed. As a single, unified data entry system, FARS/NASS GES will be compatible with the Model Minimum Uniform Crash Criteria (MMUCC), the guideline used by nearly all States to develop and revise their crash forms and databases. Once complete, the FARS/NASS GES Standardization will simplify crash data coding and analysis as well as reduce costs and errors.

Probably the most notable changes were the introduction of precrash information in FARS (already collected in NASS GES) and a change to case structure or how the groups of related data elements are organized. For example, in 2009 a FARS case consisted of Crash, Vehicle, Driver and Person coding forms. In 2010, the Person level form was split into Motor Vehicle Occupant and Non-Motor Vehicle Occupant forms, and the Precrash form was added (new to FARS, though not to NASS GES).

These structure changes also include changes to how the data are now stored and made available. For example, for FARS, there are now 16 data tables rather than 4. This results from the changes in the number of coding forms and from changes in specific data elements. Several data elements that used to allow only a specified number of responses now have a "select-all-that-apply" format. There is a separate data table for each of these data elements.

At the Crash level, a Crash Events Table was added to FARS (and modified in NASS GES). In NASS GES, Non-Harmful Events were added to the Crash Events Table.

The precrash information represents not only a new coding form, but more importantly, largely a new concept for FARS, attempting to collect data about the conditions, events and driver actions that preceded and may have contributed to the crash. Precrash data is intended to improve crash avoidance research and has been included in NASS GES since 1992.

The new FARS Precrash form information consists of 23 data elements, 9 of which were previously coded at the Crash level, 3 each at the Vehicle and Driver levels, and 8 new elements. Nine trafficway descriptor data elements were moved from the crash level to the new precrash level. These elements provide details about the characteristics of the trafficway selected for each vehicle.

A Pedestrian/Bicycle crash typing software application was added to the Non-Motor Vehicle Occupant form for both systems to help identify the precrash actions for parties involved in certain non-motorist-related crashes.

Type of Intersection was added to both systems. Bus Use and Vehicle Configuration were two Vehicle level elements that are new to NASS GES in 2010 and modified for FARS (element attributes were consolidated and redefined). Condition at Time of Crash was added at the Driver and the Non-Motor Vehicle Occupant levels for both systems. For motor vehicle occupants, there is now an Indication of Misuse of Restraint System or Helmet Use in both systems.

Some of the information that had been collected under FARS Related Factors was redistributed to new data elements. For example, some Person Related Factors have been removed and are now captured in two new Non-Motor Vehicle Occupant elements; Non-Motorist Action/Circumstances Prior to Crash and Non-Motorist Action/Circumstances at Time of Crash. Some Vehicle Related Factors are now captured under the new Precrash elements, Contributing Circumstances, Motor Vehicle and Driver Distracted By. The Driver Level element, Violations Charged, is now a "Select-all-That-Apply" element.

Multiple data elements that are part of the Model Minimum Uniform Crash Criteria (MMUCC) had the attribute "Not Reported" added in 2010 to account for information missing from the case source materials.

To ensure that data quality was not compromised as a result of the standardization, NHTSA refined and enhanced its quality control processes. These enhancements enable the identification of coding discrepancies and development of training tailored to eliminate or reduce these discrepancies.

The final phase of the FARS/NASS GES standardization will occur during the 2011 data collection year, at which point FARS and NASS GES, while remaining separate data systems, will share a single data entry system and uniform set of data elements.

New in 2010 FARS

There were many changes to the 2010 FARS, most of which are the result of NHTSA's efforts to standardize variables in FARS and the National Automotive Sampling System's (NASS) General Estimates System (GES). Additions, deletions, and changes are listed below.

Variables with Changes in Definitions and Attributes

Below is a list of FARS elements that have substantial changes for 2010. These changes, as well as others, are highlighted throughout the manual by ***bold/italic*** type.

IT IS RECOMMENDED THAT YOU REVIEW THE ENTIRE MANUAL FOR ALL CHANGES

ELEMENT #	ELEMENT NAME	NEW/ REVISED VALUES	NEW/ REVISED REMARKS	COMMENTS
C6	County	X	X	<ul style="list-style-type: none"> Added new attribute 998 – Not Reported. Added new remarks.
C7	City	X	X	<ul style="list-style-type: none"> Added new attribute 9898 – Not Reported. Added new remarks.
C8	Crash Date	X	X	<ul style="list-style-type: none"> Added GES element information. Added new GES Special Instructions. <u>UPDATE - Deleted attribute 98 - Not Reported for both Month and Day</u>
C9	Crash Time	X	X	<ul style="list-style-type: none"> Added GES element information. Added new GES Special Instructions. <u>UPDATE - Deleted attribute 9998 - Not Reported.</u>
C13	Trafficway Identifier		X	<ul style="list-style-type: none"> Updated remarks section. Added new GES Special Instructions.
C14	Milepoint	X	X	<ul style="list-style-type: none"> Added new attribute 99998 – Not Reported. Added new remarks.
C15	Global Position	X	X	<ul style="list-style-type: none"> Added new attribute 7s – Not Reported. Added new remarks.
C17	Crash Events	X	X	<ul style="list-style-type: none"> Filled in by MDE. Added new attributes. Added new remarks. GES and FARS Special Instruction Sections.

ELEMENT #	ELEMENT NAME	NEW/ REVISED VALUES	NEW/ REVISED REMARKS	COMMENTS
<p>Old C17 New C18</p>	<p>First Harmful Event</p>	<p>X</p>	<p>X</p>	<ul style="list-style-type: none"> Added new attributes: 58 – Ground, 59 – Traffic Sign Support and 98 – Not Reported. Updated attributes 01 – Rollover/Overturn, 09 – Pedalcyclist, 10 – Railway Train Vehicle, 12 – Motor Vehicle In-Transport On Same Roadway, 14 – Parked Motor Vehicle or Motor Vehicle Stopped Off Roadway, 51 – Jackknife (<i>harmful to this vehicle</i>), 45 – Working Motor Vehicle (Construction, Maintenance or Utility Vehicle), 21 – Bridge Pier or Abutment Support, 23 – Bridge Rail (<i>Includes Parapet</i>), 30 – Utility Pole/Light Support, 35 – Embankment – Earth, 42 – Tree (Standing Tree Only), 46 – Traffic Signal Support/Signal, 72 – Cargo/Equipment Loss or Shift (<i>harmful to this vehicle</i>). Deleted attributes: 13 – Motor Vehicle In-Transport on Different Roadway, 22 – Bridge Parapet End, 27 – Highway/Traffic Sign Post/Sign, 28 – Overhead Sign Support/Sign, 29 – Luminaire/Light Support, 36 – Embankment – Rock, Stone, or Concrete, 37 – Embankment – Material Type Unknown, 47 – Vehicle Occupant Struck or Run Over by Own Vehicle. Updated/Added new remarks.
<p>Old C18 New C19</p>	<p>Manner of Collision</p>	<p>X</p>	<p>X</p>	<ul style="list-style-type: none"> Added new attribute 98 – Not Reported. Updated attributes: 00 – Not a Collision with a Motor Vehicle <i>In-Transport</i>, 01 – Front-to-Rear (includes Rear End), 02 – Front-to-Front (includes Head On), 06 – Front to Side/Angle – Direction Not Specified, 11 – Other (End Swipes and Others)*. Deleted attributes: 03 – Front to Side, Same Direction, 04 – Front to Side, Opposite Direction, 05 – Front to Side, Right Angle (includes Broadside). Updated/Added new remarks.

ELEMENT #	ELEMENT NAME	NEW/ REVISED VALUES	NEW/ REVISED REMARKS	COMMENTS
Old C19 New C20	Relation to Junction	X	X	<ul style="list-style-type: none"> • Divided element into two data entries (a) Within Interchange Area and (b) Specific Location. • Format change from 1 numeric, to 2 numeric and 1 numeric one time. • Added new attributes: 16 – Shared-Use Path or Trail, 17 – Acceleration/ Deceleration Lane, 18 – Through Roadway, 98 – Not Reported. • Updated attributes: 15-19 – Unknown, Interchange Area Other Location With Interchange Area, 09 – Unknown, Non-Interchange. • Deleted attributes: 40 – Intersection, 41 – Intersection Related, 42 – Driveway Access, 43 – Entrance/Exit Ramp Related, 14 – Crossover Related. • Updated/Added new Remarks.
New C21	Type of Intersection	X	X	<ul style="list-style-type: none"> • Added new element. • Added new attributes: 1 – Not an Intersection, 2 – Four-Way Intersection, 3 – T-Intersection, 4 – Y-Intersection, 5 – Traffic Circle, 6 – Roundabout, 7 – Five Point, or More, 8 – Not Reported, 9 – Unknown. • Added new remarks and diagram.
Old C20 New C22	Relation to Trafficway	X	X	<ul style="list-style-type: none"> • Added new attribute 98 – Not Reported. • Updated attributes: 02 – On Shoulder, 03 – On Median, 04 – On Roadside, 05 – Outside Trafficway/Outside Right-of-Way, 11 – Two-way Continuous Left-Turn Lane. • Updated/Added new remarks.
Old C28 New C23	Work Zone	X	X	<ul style="list-style-type: none"> • Added new attribute 8 – Not Reported. • Added new remarks.
Old C31 New C24	Light Condition	X	X	<ul style="list-style-type: none"> • Added new attribute 8 – Not Reported. • Added new remarks.

ELEMENT #	ELEMENT NAME	NEW/ REVISED VALUES	NEW/ REVISED REMARKS	COMMENTS
Old C32 New C25	Atmospheric Conditions	X	X	<ul style="list-style-type: none"> • Format change from 1 numeric to 2 numeric. • Added new attributes: 10 – Cloudy, 11 – Blowing Snow, 98 – Not Reported • Updated attributes: 00 – No Additional Atmospheric Conditions, 01 – Clear, Cloudy (No Adverse Conditions), 02 – Rain, 03 – Sleet, Hail (Freezing Rain or Drizzle), 04 – Snow or Blowing Snow, 05 – Fog, Smog, Smoke, 06 – Severe Crosswinds, 07 – Blowing Sand, Soil, Dirt, 08 – Other, 99 – Unknown. • Added new remarks.
Old C33 New C26	School Bus Related	X	X	<ul style="list-style-type: none"> • Added new attribute 8 – Not Reported. • Added new remarks. • Added ANSI Definition for bus.
V3	Vehicle Number	X	X	<ul style="list-style-type: none"> • Deleted attribute 000 – Persons Not in Motor Vehicles. • Updated remarks. • Added GES Special Instructions.
V4	Number of Occupants	X	X	<ul style="list-style-type: none"> • Added new attribute 98 – Not Reported. • Updated/Added new remarks. • Added GES Special Instructions.
Old V37 New V6	Hit-and-Run	X	X	<ul style="list-style-type: none"> • Added new attribute 8 – Not Reported. • Updated/Added new remarks.
Old V8 New V9	Vehicle Make	X	X	<ul style="list-style-type: none"> • Added new attributes: 78 – Other Make Moped, 79 – Other Make Motored Cycle, 97 – Not Reported • Update/Added new remarks. • Added GES Special Instructions.
Old V9 New V10	Vehicle Model	X	X	<ul style="list-style-type: none"> • Added new attribute 997 – Not Reported. • Updated/Added new remarks. • Added GES Special Instructions

ELEMENT #	ELEMENT NAME	NEW/REVISED VALUES	NEW/REVISED REMARKS	COMMENTS
Old V10 New V11	Body Type	X	X	<ul style="list-style-type: none"> Added new attributes: 17 – 3-door coupe, 98 – Not Reported. Updated/Added new remarks.
Old V11 New V12	Model Year	X	X	<ul style="list-style-type: none"> Added new attribute 9998 – Not Reported. Updated/Added new remarks.
Old V12 New V13	Vehicle Identification Number	X	X	<ul style="list-style-type: none"> Added new attribute 88888888888888888888888888888888 – Not Reported Updated/Added new remarks.
Old V27 New V16	Motor Carrier Identification Number	X	X	<ul style="list-style-type: none"> Added new attribute to Issuing Authority and Identification Number: 77 – Not Reported, 777777777 – Not Reported Updated/Added new remarks. Added GES Special Instructions.
Old V30 New V17	GVWR/GCWR	X	X	<ul style="list-style-type: none"> Added new attribute 8 – Not Reported. Updated/Added new remarks.
Old V28 New V18	Vehicle Configuration	X	X	<ul style="list-style-type: none"> Added new attributes: 10 – Vehicle 10,000 pounds or less placarded for Hazardous Materials, 98 – Not Reported. Deleted attributes: 03 – Single Unit Truck (unknown number of axles, tires), 70 – Light Truck (van, minivan, panel, pickup, sport utility vehicle displaying a hazardous materials placard), 80 – Passenger Car (only when displaying a hazardous materials placards). Updated attributes: 00 – Not Applicable, not a medium/heavy truck, bus or vehicle displaying a hazardous material placard, 01 – Single-Unit Truck (two axles, 6 tires & GVWR of more than 10,000 pounds), 04 – Truck Pulling Trailer(s), 06 – Tractor/Semi-Trailer (one trailer), 07 – Truck Tractor/Doubles (two trailers), 08 – Truck Tractor/Triples (three trailers), 19 – Medium/Heavy Truck more than 10,000 lbs, cannot classify, 20 – Bus (seats for 9-15 people occupants,

ELEMENT #	ELEMENT NAME	NEW/ REVISED VALUES	NEW/ REVISED REMARKS	COMMENTS
				including driver), 21 – Bus (seats for 16 or more than 15 people occupants, including driver), 99 – Unknown If Light or Medium/Heavy Truck/Bus. • Added new remarks.
Old V31 New V19	Cargo Body Type	X	X	<ul style="list-style-type: none"> • Added new attribute 28 – Not Reported. • Added new remarks.
Old V13 New V21	Bus Use	X	X	<ul style="list-style-type: none"> • Format change from <u>1 numeric</u> to <u>2 numeric</u>. • Added new attribute 98 – Not Reported. • Deleted attributes: 01 – Not Used as a Bus, 02 – Used as a Private School Bus, 03 – Used as a School Bus, Public or Private Unknown • Updated attributes: 00 – Not Used as a Bus, 01 – Used as a Public School Bus, 04 – Used as Scheduled Service Bus Intercity, 05 – Used as a Tour Bus Charter/Tour, 06 – Used as a Commuter Bus Transit/Commuter, 07 – Used as a Shuttle Bus, 99 – Unknown Bus Use • Added new remarks
Old V14 New V22	Special Use	X	X	<ul style="list-style-type: none"> • Format change from <u>1 numeric</u> to <u>2 numeric</u>. • Added new attribute 98 – Not Reported. • Added new remarks
Old V15 New V23	Emergency Use	X	X	<ul style="list-style-type: none"> • Added new attribute 8 – Not Reported. • Added new remarks
Old V16 New V24	Travel Speed	X	X	<ul style="list-style-type: none"> • Added new attribute 998 – Not Reported. • Added new remarks.
V17	Vehicle Maneuver			<ul style="list-style-type: none"> • Deleted Element

ELEMENT #	ELEMENT NAME	NEW/ REVISED VALUES	NEW/ REVISED REMARKS	COMMENTS
V18	Crash Avoidance Maneuver			<ul style="list-style-type: none"> Deleted Element
V28	Vehicle Role			<ul style="list-style-type: none"> Deleted Element
Old V22 New V28	Impact Points - Initial/ Principal changed to Areas of Impact – Initial Damage /Most Damaged	X	X	<ul style="list-style-type: none"> Added new attributes: 61 – Left, 62 – Left-Front Half, 63 – Left-Back Half, 81 – Right, 82 – Right-Front Half, 83 – Right-Back Half, 98 – Not Reported. Updated attribute 18 – This Vehicle Set Something in Motion Causing Injury or Damage (Not a Clock Point) Set-In-Motion (Not a Clock Point). Added new remarks and examples. Added new diagram.
Old V25 New V29	Extent of Damage	X	X	<ul style="list-style-type: none"> Added new attribute 8 – Not Reported. Added new remarks.
Old V26 New V30	Vehicle Removal	X	X	<ul style="list-style-type: none"> Added new attribute 8 – Not Reported. Added new remarks.
Old V33 New V31	Sequence of Events	X	X	<ul style="list-style-type: none"> Added new attributes: 58 – Ground, 59 – Traffic Sign Support, 68 – Cross Centerline, 69 – Re-entering Highway, 70 – Jackknife (non-harmful), 72 – Cargo/Equipment (harmful to this vehicle), 98 – Not Reported. Updated attributes: 01 - Overturn/Rollover Rollover/Overturn, 02 – Fire/Explosion (Always code if present), 06 – Injured in Vehicle (Non-Collision), 09 – Pedal Cycle Pedalcyclist, 10 – Railway Train Vehicle, 12 – Motor Vehicle In-Transport on Same Roadway, 14 – Parked Motor Vehicle or Motor Vehicle Stopped Off Roadway, 21 – Bridge Pier or Abutment Support, 23 – Bridge Rail (Includes Parapet), 30 – Utility Pole/Light Support, 35 – Embankment – Earth, 42 – Tree (Standing Tree Only), 44 - Pavement Surface Irregularity (Pothole, Grooved, Grates) (Ruts, Potholes, Grates, etc.), 45 –

ELEMENT #	ELEMENT NAME	NEW/ REVISED VALUES	NEW/ REVISED REMARKS	COMMENTS
				<p>Working Motor Vehicle (Construction, Maintenance or Utility Vehicle), 51 – Jackknife (<i>harmful to this vehicle</i>), 46 – Traffic Signal Support/Signal, 60 – Cargo/Equipment Loss or Shift (<i>non-harmful</i>), 65 – Cross Median/Centerline.</p> <ul style="list-style-type: none"> Deleted attributes: 13 – Motor Vehicle In-Transport on Different Roadway, 22 – Bridge Parapet End, 27 – Highway/Traffic Sign Post/Sign, 28 – Overhead Sign Support/Sign, 29 – Luminaire/Light Support, 36 – Embankment Rock, Stone, or Concrete, 37 – Embankment Material Type Unknown, 47 – Vehicle Occupant Struck or Run Over by Own Vehicle. Added new remarks. Updated remarks and examples.
<p>Old V34 New V32</p>	<p>Most Harmful Event</p>	<p>X</p>	<p>X</p>	<ul style="list-style-type: none"> Added new attributes: 58 – Ground, 59 – Traffic Sign Support, 98 – Not Reported Updated attributes: 01 - Overturn/Rollover Rollover/Overturn, 02 – Fire/Explosion (Always code if present), 06 – Injured in Vehicle (Non-Collision), 09 – Pedal Cycle Pedalcyclist, 10 – Railway Train Vehicle, 12 – Motor Vehicle In-Transport on Same Roadway, 14 – Parked Motor Vehicle or Motor Vehicle Stopped Off Roadway, 21 – Bridge Pier or Abutment Support, 23 – Bridge Rail (Includes Parapet), 30 – Utility Pole/Light Support, 35 – Embankment –Earth, 42 – Tree (Standing Tree Only), 44 - Pavement Surface Irregularity (Pothole, Grooved, Grates) (Ruts, Potholes, Grates, etc.), 45 – Working Motor Vehicle (Construction, Maintenance or Utility Vehicle), 51 – Jackknife (<i>harmful to this vehicle</i>), 46 – Traffic Signal Support/Signal, 72 – Cargo/Equipment Loss or Shift (<i>harmful</i>), 65 – Cross Median/Centerline. Deleted attributes: 13 – Motor Vehicle

ELEMENT #	ELEMENT NAME	NEW/ REVISED VALUES	NEW/ REVISED REMARKS	COMMENTS
				<p>In Transport on Different Roadway, 22 Bridge Parapot End, 27 Highway/Traffic Sign Post/Sign, 28 Overhead Sign Support/Sign, 29 Luminaire/Light Support, 36 Embankment Rock, Stone, or Concrete, 37 Embankment Material Type Unknown, 47 Vehicle Occupant Struck or Run Over by Own Vehicle.</p> <ul style="list-style-type: none"> Added new remarks.
<p>Old V35 New V33</p>	<p>Related Factors – Vehicle Level</p>	<p>X</p>		<ul style="list-style-type: none"> Deleted attributes: 01 Tires, 02 Brake System, 03 Steering System, 04 Suspension, 05 Power Train, 06 Exhaust System, 07 Headlights, 08 Signal Lights, 09 Other Lights, 10 Horn, 11 Mirrors, 12 Wipers, 13 Driver Seating and Control, 14 Body, Doors, Hood and Other, 15 Trailer Hitch, 16 Wheels, 17 Air Bag, 18 Other Vehicle Defects, 19 Safety Bolts.
<p>D5</p>	<p>Driver's License State</p>	<p>X</p>	<p>X</p>	<ul style="list-style-type: none"> Added new attributes: <i>00 – No Driver Present, 98 – Not Reported.</i> Added new remarks.
<p>D6</p>	<p>Driver's Zip Code</p>	<p>X</p>	<p>X</p>	<ul style="list-style-type: none"> Added new attribute <i>99998 – No Driver Present.</i> Added new remarks. Added new GES Special Instructions.
<p>D8</p>	<p>Commercial Motor Vehicle License Status</p>	<p>X</p>	<p>X</p>	<ul style="list-style-type: none"> Format change from <u>1 numeric</u> to <u>2 numeric</u>. Added new attribute <i>98 – Not Reported.</i> Updated attribute – <i>99 – Unknown.</i> Added new remarks.
<p>D9</p>	<p>Compliance with License Endorsements changed to Compliance with CDL</p>	<p>X</p>	<p>X</p>	<ul style="list-style-type: none"> Added new attribute <i>8 – Not Reported.</i> Added new remarks.

ELEMENT #	ELEMENT NAME	NEW/ REVISED VALUES	NEW/ REVISED REMARKS	COMMENTS
	<i>Endorsements</i>			
D10	License Compliance with Class of Vehicle	X	X	<ul style="list-style-type: none"> Added new attribute 7 – Not Reported. Updated reference table. Added new remarks.
D11	Compliance with License Restrictions	X	X	<ul style="list-style-type: none"> Added new attribute 8 – Not Reported. Added new remarks.
D21	Violations Charged	X	X	<ul style="list-style-type: none"> Format change from 2 numeric, 3 times to select all that apply. Added new attribute 97 – Not Reported. Added new remarks.
New D23 New NM14	Condition (Impairment) at Time of Crash	X	X	<ul style="list-style-type: none"> Add new element which is located on two forms. Format – select all that apply. New attributes: 00 – None/Apparently Normal, 01 – Ill, Blackout, 02 – Asleep or Fatigued, 03 – Walking with a Cane or Crutches, 04 – Paraplegic Or Restricted To A Wheelchair, 05 – Impaired Due To Previous Injury, 06 – Deaf, 07 – Blind, 08 – Emotional (depressed, angry, disturbed, etc.), 09 – Under the Influence of Alcohol, Drugs or Medication, 10 – Physical Impairment – No Details, 96 – Other Physical Impairment, 98 – Not Reported, 99 – Unknown If Physically Impaired. New remarks.
D24	Related Factors – Driver Level	X		<ul style="list-style-type: none"> Deleted attributes: 01 – Drowsy, Sleepy, Asleep Fatigued, 02 – Ill, Passed Out/Blackout, 03 – Emotional (e.g., Depression, Angry, Disturbed), 05 – Under the Influence of Alcohol, Drugs or Medication, 07 – Restricted to Wheelchair, 06 – Operating the Vehicle in Careless or Inattentive

ELEMENT #	ELEMENT NAME	NEW/ REVISED VALUES	NEW/ REVISED REMARKS	COMMENTS
				<p>Thought In, 09 – Impaired Due to Previous Injury, 11 – Other Physical Impairment, 93 – Cellular Telephone Present in Vehicle, 94 – Cellular Telephone in Use in Vehicle, 95 – Computer/Fax Machines/Printers, 96 – Onboard Navigation System, 97 – Two-way Radio, 98 – Head-up Display.</p>
New PC4	Contributing Circumstances, Motor Vehicle	X	X	<ul style="list-style-type: none"> • Added new element. • Format – 2 digits • Added new attributes: 00 – None, 01 – Tires, 02 – Brake System, 03 – Steering, 04 – Suspension, 05 – Power Train, 06 – Exhaust System, 07 – Head Lights, 08 – Signal Lights, 09 – Other Lights, 10 – Wipers, 11 – Wheels, 12 – Mirrors, 13 – Windows/Windshield, 14 – Body, Doors, 15 – Truck Coupling / Trailer Hitch / Safety Chains, 16 – Safety Systems, 17 – Vehicle Contributing Factors – No Details, 97 – Other, 98 – Not Reported, 99 – Unknown. • Added new remarks.
Old C21 New PC5	Trafficway Flow change to Trafficway Description	X	X	<ul style="list-style-type: none"> • Element moved from Crash Level to Precrash (Vehicle/Driver) Level. • Added new attributes: 0 – Non-Trafficway Area, 8 – Not Reported. • Updated attributes: 1 – Not Physically Divided (Two-Way, Trafficway Not Divided), 5 – Not Physically Divided (With Two-Way, Not Divided with a Continuous Left-Turn Lane), 2 – Divided Highway, Median Strip (Without Traffic Barrier) Two-Way, Divided, Unprotected (Painted > 4 Feet) Median, 3 – Divided Highway, Median Strip (With Traffic Barrier) Two-Way, Divided, Positive Median Barrier. • Added new remarks.

ELEMENT #	ELEMENT NAME	NEW/ REVISED VALUES	NEW/ REVISED REMARKS	COMMENTS
Old C22 New PC6	Number of Travel Lanes changed to Total Lanes in Roadway	X	X	<ul style="list-style-type: none"> Element moved from Crash Level to Precrash (Vehicle/Driver) Level. Added new attributes: 0 – Non-Trafficway Area, 8 – Not Reported. Added new remarks.
Old C23 New PC7	Speed Limit	X	X	<ul style="list-style-type: none"> Element moved from Crash Level to Precrash (Vehicle/Driver) Level. Added new attribute 98 – Not Reported. Updated remark 00 – No Statutory Limit/Non-Trafficway Area. Added new remarks.
Old C24 New PC8	Roadway Alignment	X	X	<ul style="list-style-type: none"> Element moved from Crash Level to Precrash (Vehicle/Driver) Level. Added new attributes: 0 – Non-Trafficway Area, 3 – Curve Left, 4 – Curve – Unknown Direction, 8 – Not Reported. Updated attribute 2 – Curve Right.
Old C25 New PC9	Roadway Profile changed to Roadway Grade	X	X	<ul style="list-style-type: none"> Element moved from Crash Level to Precrash (Vehicle/Driver) Level. Added new attributes: 0 – Non-Trafficway Area, 5 – Uphill, 6 – Downhill, 8 – Not Reported. Updated attributes: 2 – Grade, Unknown Slope, 4 – Sag (Bottom). Added new remarks. Added new diagram.
Old C26 New PC10	Roadway Surface Type	X	X	<ul style="list-style-type: none"> Element moved from Crash Level to Precrash (Vehicle/Driver) Level. Added new attributes: 0 – Non-Trafficway Area, 8 – Not Reported. Updated attribute 78 – Other. Added new remarks.

ELEMENT #	ELEMENT NAME	NEW/REVISED VALUES	NEW/REVISED REMARKS	COMMENTS
Old C27 New PC11	Roadway Surface Conditions	X	X	<ul style="list-style-type: none"> Element moved from Crash Level to Precrash (Vehicle/Driver) Level. Format change from <u>1 numeric</u> to <u>2 numeric</u>. Added new attributes: 00 – Non-Trafficway Area, 10 – Slush, 11 – Mud, Dirt or Gravel, 98 – Not Reported. Updated attributes: 03 – Snow or Slush, 05 – Sand, Dirt, Mud, Gravel, 99 – Unknown. Added new remarks.
Old C29 New PC12	Traffic Control Device	X	X	<ul style="list-style-type: none"> Element moved from Crash Level to Precrash (Vehicle/Driver) Level. Added new attributes: 32 – School Zone Sign/Device, 65 – Railway Crossing Device, 97 – Not Reported. Updated attributes: 29 – Unknown Type-Regulatory Sign, 50 – Officer, crossing guard, flagman, etc. Person. Deleted attributes: 05 – Flashing beacon, 06 – Flashing highway traffic signal, type unknown or other than traffic control or beacon, 30 – School speed limit sign, 31 – School advance or crossing sign, 38 – Other school related sign, 39 – Unknown type school zone sign, 41 – Electric Warning Sign, 60 – Gates, 61 – Flashing Lights, 62 – Traffic Control Signal, 63 – Wigwags, 64 – Bolls, 68 – Other train activated device, 69 – Active device, type unknown, 70 – Cross bucks, 71 – Stop sign, 72 – Other railroad crossing sign, 73 – Special warning device – watchman, flagged by crew, 78 – Other passive device, 79 – Passive device, type unknown, 80 – Grade crossing controlled, type unknown. Added new remarks.
Old C30 New PC13	Traffic Control Device Functioning changed to Device	X	X	<ul style="list-style-type: none"> Element moved from Crash Level to Precrash (Vehicle/Driver) Level. Added new attribute 8 – Not Reported. Attribute change to element values “00– Not Applicable–Occupant of a Motor

ELEMENT #	ELEMENT NAME	NEW/ REVISED VALUES	NEW/ REVISED REMARKS	COMMENTS
	<i>Functioning</i>			<p>Vehicle In-Transport or Not In-Transport (Including Motor Vehicle Parked/Stopped Off Roadway/Working/In Motion Outside the Trafficway) to 000 - Not Applicable-Occupant of a Motor Vehicle In-Transport or Not In-Transport (Including Motor Vehicle Parked/Stopped Off Roadway/Working/In Motion Outside the Trafficway).</p> <ul style="list-style-type: none"> Updated/Added new remarks.
<i>New PC14</i>	<i>Driver Distracted By</i>	X	X	<ul style="list-style-type: none"> Moved from Driver level to Precrash Level. Format change from <u>2 numeric</u> to <u>select all that apply</u>. Add new attribute 95 – No Driver Present. Update/Added new remarks.
<i>New PC15</i>	<i>Driver Maneuvered to Avoid</i>	X	X	<ul style="list-style-type: none"> Added new attributes: 00 – Driver Did Not Maneuver To Avoid, 01 – Object, 02 – Poor Road Conditions (Puddle, Ice, Pothole, etc.), 03 – Live Animal, 04 – Motor Vehicle, 05 – Pedestrian, Pedalcyclist or Other Non-Motorist, 92 – Phantom/Non-contact Motor Vehicle, 95 – No Driver Present, 98 – Not Reported, 99 – Unknown. Format – select all that apply. Added new remarks.
<i>New PC16</i>	<i>Driver’s Vision Obscured By</i>	X	X	<ul style="list-style-type: none"> Added new attributes: 00 – Not Distracted, 01 – Looked But Did Not See, 03 – By Other Occupant(s), 04 – By Moving Object in Vehicle, 05 – While Talking or Listening to Cellular Phone, 06 – While Dialing Cellular Phone, 07 – Adjusting Audio And/or Climate Controls, 09 – While Using Other Device/Controls Integral to Vehicle, 10 – While Using or Reaching For Device/Object Brought Into Vehicle, 12 – Distracted by Outside Person, Object or Event, 13 – Eating or Drinking, 14 – Smoking Related, 15 – Other Cellular Phone

ELEMENT #	ELEMENT NAME	NEW/ REVISED VALUES	NEW/ REVISED REMARKS	COMMENTS
				<p><i>Related, 16 – No Driver Present, 92 – Distraction/ Inattention, Details Unknown, 96 – Not Reported, 97 – Inattentive or Lost in Thought, 98 – Other Distraction, 99 – Unknown if Distracted.</i></p> <ul style="list-style-type: none"> • Format – select all that apply. • Added new remarks.
<p>New PC17</p>	<p><i>Pre-Event Movement (Prior to Recognition of Critical Event)</i></p>	<p>X</p>	<p>X</p>	<ul style="list-style-type: none"> • Added new attributes: <i>00 – No Driver Present, 01 – Going Straight, 02 – Decelerating in Traffic Lane, 03 – Accelerating in Traffic Lane, 04 – Starting in Traffic Lane, 05 – Stopped in Traffic Lane, 06 – Passing or Overtaking Another Vehicle, 07 – Disabled or Parked in Travel Lane, 08 – Leaving a Parking Position, 09 – Entering a Parking Position, 10 – Turning Right, 11 – Turning Left, 12 – Making a U-Turn, 13 – Backing Up (other than for Parking Position), 14 – Negotiating a Curve, 15 – Changing Lanes, 16 – Merging, 17 – Successful Avoidance to a Previous Critical Event, 98 – Other (specify:), 99 – Unknown.</i> • Format – 2 numeric. • Added new remarks.
<p>New PC18</p>	<p><i>Critical Event – Precrash (Category)</i></p>	<p>X</p>	<p>X</p>	<ul style="list-style-type: none"> • Added new attributes: <i>1 – This Vehicle Loss of Control Due To:, 2 – This Vehicle Traveling. 3 – Other Motor Vehicle in Lane, 4 – Other Motor Vehicle Encroaching into Lane, 5 – Pedestrian or Pedalcyclist or Other Non-Motorist, 6 – Object or Animal, 7 – Other (specify:), 9 – Unknown.</i> • Format – 1 numeric. • Added new remarks.

ELEMENT #	ELEMENT NAME	NEW/REVISED VALUES	NEW/REVISED REMARKS	COMMENTS
New PC19	Critical Event – Precrash (Event)	X	X	<ul style="list-style-type: none"> Added new attributes: 01 – This Vehicle Loss Of Control Due To: Blow out/flat tire, 02 – This Vehicle Loss Of Control Due To: Stalled Engine, 03 – This Vehicle Loss Of Control Due To: Disabling vehicle failure (e.g., wheel fell off) (specify:), 04 – This Vehicle Loss Of Control Due To: Non-disabling vehicle problem (e.g., hood flew up)(specify:), 05 – This Vehicle Loss Of Control Due To: Poor road conditions (puddle, pothole, ice, etc.) (specify:), 06 – This Vehicle Loss Of Control Due To: Traveling too fast for conditions, 08 – This Vehicle Loss Of Control Due To: Other cause of control loss (specify:), 09 – This Vehicle Loss Of Control Due To: Unknown cause of control loss, 10 – This Vehicle Traveling: Over the lane line on left side of travel lane, 11 – This Vehicle Traveling: Over the lane line on right side of travel lane, 12 – This Vehicle Traveling: Off the edge of the road on the left side, 13 – This Vehicle Traveling: Off the edge of the road on the right side, 14 – This Vehicle Traveling: End departure, 15 – This Vehicle Traveling: Turning left at intersection, 16 – This Vehicle Traveling: Turning right at intersection, 17 – This Vehicle Traveling: Crossing over (passing through) intersection, 18 – This Vehicle Traveling: This vehicle decelerating, 19 – This Vehicle Traveling: Unknown travel direction, 50 – Other Motor Vehicle in Lane: Other vehicle stopped, 51 – Other Motor Vehicle in Lane: Traveling in same direction with lower steady speed, 52 – Other Motor Vehicle in Lane: Traveling in same direction while decelerating, 53 – Other Motor Vehicle in Lane: Traveling in same direction with higher speed, 54 – Other Motor Vehicle in Lane: Traveling in opposite direction, 55 – Other Motor Vehicle in Lane: In

ELEMENT #	ELEMENT NAME	NEW/ REVISED VALUES	NEW/ REVISED REMARKS	COMMENTS
				<p><i>crossover, 56 – Other Motor Vehicle in Lane: Backing, 59 – Other Motor Vehicle in Lane: Unknown travel direction of the other motor vehicle in lane, 60 – Other Motor Vehicle Encroaching into Lane: From adjacent lane (same direction) over left lane line, 61 – Other Motor Vehicle Encroaching into Lane: From adjacent lane (same direction) over right lane line, 62 – Other Motor Vehicle Encroaching into Lane: From opposite direction over left lane line, 63 – Other Motor Vehicle Encroaching into Lane: From opposite direction over right lane line, 64 – Other Motor Vehicle Encroaching into Lane: From parking lane, median, shoulder, roadside, 65 – Other Motor Vehicle Encroaching into Lane: From crossing street, turning into same direction, 66 – Other Motor Vehicle Encroaching into Lane: From crossing street, across path, 67 – Other Motor Vehicle Encroaching into Lane: From crossing street, turning into opposite direction, 68 – Other Motor Vehicle Encroaching into Lane: From crossing street, intended path not known, 70 – Other Motor Vehicle Encroaching into Lane: From driveway, turning into same direction, 71 – Other Motor Vehicle Encroaching into Lane: From driveway, across path, 72 – Other Motor Vehicle Encroaching into Lane: From driveway, turning into opposite direction, 73 – Other Motor Vehicle Encroaching into Lane: From driveway, intended path not known, 74 – Other Motor Vehicle Encroaching into Lane: From entrance to limited access highway, 78 – Other Motor Vehicle Encroaching into Lane: Encroachment by other vehicle details unknown, 80 – Pedestrian, Pedalcyclist Or Other Non-Motorist: Pedestrian in roadway, 81 –</i></p>

ELEMENT #	ELEMENT NAME	NEW/ REVISED VALUES	NEW/ REVISED REMARKS	COMMENTS
				<p><i>Pedestrian, Pedalcyclist Or Other Non-Motorist: Pedestrian approaching roadway, 82 – Pedestrian, Pedalcyclist Or Other Non-Motorist: Pedestrian unknown location, 83 – Pedestrian, Pedalcyclist Or Other Non-Motorist: Pedalcyclist or other non-motorist in roadway (specify:), 84 – Pedestrian, Pedalcyclist Or Other Non-Motorist: Pedalcyclist or other non-motorist approaching roadway (specify:), 85 – Pedestrian, Pedalcyclist Or Other Non-Motorist: Pedalcyclist or other non-motorist unknown location (specify:), 87 – Object or Animal: Animal in roadway, 88 – Object or Animal: Animal approaching roadway, 89 – Object or Animal: Animal -unknown location, 90 – Object or Animal: Object in roadway, 91 – Object or Animal: Object approaching roadway, 92 – Object or Animal: Object unknown location, 98 – Other critical pre-crash event (specify:), 99 – Unknown.</i></p> <ul style="list-style-type: none"> • Format – 2 numeric. • Added new remarks.
<i>New PC20</i>	<i>Attempted Avoidance Maneuver</i>	X	X	<ul style="list-style-type: none"> • Added new attributes: <i>00 – No Driver Present, 01 – No Avoidance Maneuver, 02 – Braking (no lockup), 03 – Braking (lockup), 04 – Braking (lockup unknown), 05 – Releasing brakes, 06 – Steering left, 07 – Steering right, 08 – Braking and steering left, 09 – Braking and steering right, 10 – Accelerating, 11 – Accelerating and steering left, 12 – Accelerating and steering right, 98 – Other Action (specify:), 99 – Unknown.</i> • Format – 2 numeric. • Added new remarks. • Added GES Special Instructions.

ELEMENT #	ELEMENT NAME	NEW/ REVISED VALUES	NEW/ REVISED REMARKS	COMMENTS
New PC21	<i>Pre-Impact Stability</i>	X	X	<ul style="list-style-type: none"> Added new attributes: 0 – No Driver Present, 1 – Tracking, 2 – Skidding longitudinally — rotation less than 30 degrees, 3 – Skidding laterally — clockwise rotation, 4 – Skidding laterally — counter-clockwise rotation, 7 – Other vehicle loss-of-control (specify:), 9 – Precrash stability unknown. Format – 1 numeric. Added new remarks.
New PC22	<i>Pre-Impact Location</i>	X	X	<ul style="list-style-type: none"> New attributes: 0 – No Driver Present, 1 – Stayed in Original Travel Lane, 2 – Stayed on Roadway, but Left Original Travel Lane, 3 – Stayed on Roadway, not Known if Left Original Travel Lane, 4 – Departed Roadway, 5 – Remained off Roadway, 6 – Returned to Roadway, 7 – Entered Roadway, 9 – Unknown. Format – 1 numeric. Added new remarks
New PC23	<i>Crash Type</i>	X	X	<ul style="list-style-type: none"> Added new attributes: 00 – No Impact, Actual attribute 01-93, 98 – Other Crash Type, 99 – Unknown. Format – 2 numeric. Added new remarks. Added GES Special Instructions.
P3	Vehicle Number - Person Level	X		<ul style="list-style-type: none"> Deleted attribute 000 – Not a Motor Vehicle Occupant. Added GES Special Instructions.
Old P6 New P5 and NM5	Age	X	X	<ul style="list-style-type: none"> Element located on two forms. Added new attribute 998 – Not Reported. Added new remarks.
Old P7 New P6 and NM6	Sex	X	X	<ul style="list-style-type: none"> Element located on two forms. Added new attribute 8 – Not Reported. Added new remarks.

ELEMENT #	ELEMENT NAME	NEW/ REVISED VALUES	NEW/ REVISED REMARKS	COMMENTS
Old P8 New P7	Person Type	X	X	<ul style="list-style-type: none"> Element was split between Occupant and Non-Motorist Person Level forms. Added attribute 88 – Not Reported. Attributes moved to Person Type NM7 - 04 – Occupant of a Non-Motor Vehicle Transport Device, 05 – Pedestrian, 06 – Bicyclist, 07 – Other Bicyclist, 08 – Person on Personal Conveyance, 10 – Persons in/On Buildings, 19 – Unknown Type of Non-Motorist. Added new remarks. Added GES Special Instructions.
Old P22 New P8 and NM8	Injury Severity	X	X	<ul style="list-style-type: none"> Element located on two forms. Added new attribute 8 – Not Reported. Added new remarks. Added GES Special Instructions.
P9	Seating Position	X	X	<ul style="list-style-type: none"> Added new attribute 98 – Not Reported. Deleted attribute 00 – Not a Motor Vehicle Occupant. Added new remarks. Added GES Special Instructions.
P10	Protection System Use changed to Restraint System/ Helmet Use	X	X	<ul style="list-style-type: none"> Added new attributes: 07 – None Used-Motor Vehicle Occupant, 16 – Other Helmet, 17 – No Helmet, 97 – Other, 98 – Not Reported. Updated attributes: 00 – None Used/Not Applicable – Not a Motor Vehicle Occupant, 01 – Shoulder Belt Only Used, 02 – Lap Belt Only Used, 03 – Lap and Shoulder Shoulder and Lap Belt Used, 04 – Child Safety Seat/Booster Restraint Type Unknown/Not Reported, 05 – DOT Compliant Motorcycle Helmet, 10 – Child Safety Seat Restraint System – Forward Facing, 11 – Child Safety Seat Restraint System – Rear Facing, 12 – Booster Seat (lap and shoulder belt used properly), Deleted attributes: 06 – Bicycle Helmet, 14 – Child Safety Seat/Booster Seat Used Properly, 15

ELEMENT #	ELEMENT NAME	NEW/ REVISED VALUES	NEW/ REVISED REMARKS	COMMENTS
				<p>Helmets Used Improperly.</p> <ul style="list-style-type: none"> Added new remarks. Added FARS Special Instructions. Added GES Special Instructions.
New P11	Any Indication of Mis-Use of Restraint System or Helmet Use	X	X	<ul style="list-style-type: none"> Added new element. Added new attributes: 0 – No, 1 – Yes. Added new remarks.
Old P11 New P12	Air Bag Deployed	X	X	<ul style="list-style-type: none"> Added new attribute 98 – Not Reported. Added new remarks. Added GES Special Instructions.
Old P12 New P13	Ejection	X	X	<ul style="list-style-type: none"> Added new attribute 7 – Not Reported. Added new remarks.
P18 and NM17	Alcohol Test	X	X	<ul style="list-style-type: none"> Element is now located on two forms. Added new attributes: Status: 8 – Not Reported, Type: 95 – Not Reported, Result: 95 – Not Reported. Updated attributes: Status: 9 – Unknown if Tested /Not Reported, Type: 99 – Unknown if Tested /Not Reported, Result: 99 – Unknown if Tested /Not Reported. Updated/Added new remarks.
P21 and NM20	Drug Test	X	X	<ul style="list-style-type: none"> Element now located on two forms. Added new attributes: Status: 8 – Not Reported, Type: 6 – Not Reported, Result: 095 – Not Reported. Updated attributes: Status: 9 – Unknown if Tested /Not Reported, Type: 9 – Unknown if Tested /Not Reported, Result: 999 – Unknown if Tested /Not Reported. Updated/Added new remarks. Updated Drug Lists.

ELEMENT #	ELEMENT NAME	NEW/REVISED VALUES	NEW/REVISED REMARKS	COMMENTS
Old P23 New P22 and NM21	Transported for Treatment By changed to Transported to Medical Facility By	X	X	<ul style="list-style-type: none"> • Element located on two forms. • Added new attributes: 5 – EMS Ground, 6 – Other, 8 – Not Reported • Updated attributes: 1 – Yes, EMS Air, 2 – Yes, Law Enforcement, 3 – Yes, Other EMS Unknown Mode, 4 – Yes, Transported by Unknown Source. • Added new remarks. • Added GES Special Instructions.
Old P27 New P26	Related Factors - Person Level changed to Related Factors - (Motor Vehicle Occupant) Person Level			<ul style="list-style-type: none"> • Deleted attributes: 01 – Not Visible, 02 – Darting, Running or Stumbling Into Roadway, 03 – Improper Crossing of Roadway or Intersection, 04 – Walking/Riding With or Against Traffic, Playing, Working, Sitting, Lying, Standing, etc., in Roadway, 06 – Ill, Passed Out/Blackout, 07 – Emotional (e.g., Depression, Angry, Disturbed), 10 – Inattentive, 11 – Walking with Cane or Crutches, 12 – Restricted to Wheelchair, 13 – Motorized Wheelchair Rider, 14 – Impaired Due to Previous Injury, 15 – Under the Influence of Alcohol, Drugs or Medication, 16 – Blind, 17 – Other Physical Impairment, 19 – Pedestrian Jogging, 23 – Failure to Dim Lights or Have Lights on When Required, 24 – Operating Without Required Equipment, 27 – Improper or Erratic Lane Changing, 30 – Making Improper Entry to or Exit from Trafficway, 34 – Passing on Wrong Side, 35 – Passing with Insufficient Distance or Inadequate Visibility or Failing to Yield to Overtaking Vehicle, 36 – Operating the Vehicle in an Erratic, Reckless, Careless or Negligent Manner, 38 – Failure to Yield the Right of Way, 39 – Failure to Obey Actual Traffic Sign, 48 – Making Other Improper Turn, 49 – Driving Wrong Way on One Way Trafficway, 50 – Driving on Wrong Side of Road, 53 – Stopped in Roadway (Vehicle Not Abandoned), 55 – Getting Off/Out of or On/In to a Transport Vehicle, 79 – Live Animals in Road, 90 – Non-

ELEMENT #	ELEMENT NAME	NEW/ REVISED VALUES	NEW/ REVISED REMARKS	COMMENTS
				<p>Motorist Pushing a Vehicle.</p> <ul style="list-style-type: none"> Added new remarks.
<p>Old P5 New NM4</p>	<p>Non-Occupant Striking Vehicle Number changed to Number of Motor Vehicle Striking Non-Motorist</p>	<p>X</p>	<p>X</p>	<ul style="list-style-type: none"> Element moved to Non-Motorist Person Level form. Deleted attribute 000 – Not Applicable – Occupant of a Motor Vehicle In-Transport or Not In-Transport (Including Parked/Stopped Off Roadway/Working/In Motion Outside In Trafficway) Added new remarks. Added GES Special Instructions.
<p>NM7</p>	<p>Person Type</p>	<p>X</p>	<p>X</p>	<ul style="list-style-type: none"> Add new attribute: 88 – Not Reported. Moved attributes from P7 – Person Type: 04 – Occupant of a Non-Motor Vehicle Transport Device, 05 – Pedestrian, 06 – Bicyclist, 07 – Other Cyclist, 08 – Person on Personal Conveyance, 10 – Person In/On Buildings, 88 – Not Reported, 19 – Unknown Type of Non-Motorist. Added new remarks.
<p>NM9</p>	<p>Pedestrian/ Bike Typing</p>	<p>X</p>	<p>X</p>	<ul style="list-style-type: none"> Added new element. Format – Element entered in MDE system. Remarks added by headquarters
<p>Old P15 New NM10</p>	<p>Non-Occupant Location changed to Non-Motorist Location at Time of Crash</p>			<ul style="list-style-type: none"> Element moved to Non-Motorist Person Level form. Added attributes: 14 – Parking Lane Zone, 20 – Shoulder/Roadside, 21 – Sidewalk, 22 – Median/Crossing Island, 23 – Driveway Access, 24 – Shared-Use Path/Trail, 25 – Non-Trafficway Area, 28 – Other, 98 – Not Reported. Deleted attributes: 00 – No Applicable – Occupant of a Motor Vehicle In-Transport or Not In-Transport (Including Motor Vehicles Parked/Stopped Off Roadway/Working/In Motion Outside the Trafficway) and Injured Railway

ELEMENT #	ELEMENT NAME	NEW/ REVISED VALUES	NEW/ REVISED REMARKS	COMMENTS
				<p>Train Occupants, 04 – Intersection – On Roadway, Crosswalk Availability Unknown, 05 – Intersection – Not on Roadway, 12 – Non-Intersection – On Roadway, Crosswalk not Available, 15 – Non-Intersection – On Road Shoulder, 17 – Non-Intersection – Outside Trafficway, 18 – Non-Intersection – Other, Not on Roadway, 19 – Non-Intersection – Unknown.</p> <ul style="list-style-type: none"> Updated to attributes: 01 – Intersection – In Marked Crosswalk, 02 – Intersection – On Roadway, Not in Unmarked Crosswalk, 03 – Intersection – On Roadway, Not In Crosswalk not Available, 09 – Intersection – Unknown Location, 10 – Non-Intersection – In Marked Crosswalk, 14 – Non-Intersection – In Parking Lane/Zone, 16 – Non-Intersection – Bike Path Bicycle Lane, 99 – Unknown Location. Added new remarks.
<p>New NM11</p>	<p>Non-Motorist Action/Circumstances Prior to Crash</p>	<p>X</p>	<p>X</p>	<ul style="list-style-type: none"> Added new element. Added attributes: 01 – Going To or From School (K-12), 02 – Waiting to Cross Roadway, 03 – Crossing Roadway, 04 – Jogging/Running, 05 – Movement Along Roadway with Traffic (In or Adjacent to Travel Lane), 06 – Movement Along Roadway Against Traffic (In or Adjacent to Travel Lane), 07 – Movement on Sidewalk, 08 – In Roadway – Other (Working, Playing, Etc.), 09 – Adjacent to Roadway (e.g., Shoulder, Median), 10 – Working in Trafficway (Incident Response), 11 – Entering/Exiting a Vehicle, 12 – Disabled Vehicle Related (Working on, Pushing, Leaving/ Approaching), 14 – Other, 15 – None, 98 – Not Reported, 99 – Unknown. Format: select all that apply. Added new remarks.

ELEMENT #	ELEMENT NAME	NEW/REVISED VALUES	NEW/REVISED REMARKS	COMMENTS
<p>New NM12</p>	<p>Non-Motorist Action/Circumstances at Time of Crash</p>	<p>X</p>	<p>X</p>	<ul style="list-style-type: none"> • Added new element. • Added new attributes: 00 – No Improper Action, 01 – Dart/Dash, 02 – Failure to Yield Right-Of-Way, 3 – Failure to Obey Traffic Signs, Signals or Officer, 04 – In Roadway Improperly (Standing, Lying, Working, Playing), 05 – Entering/Exiting a Vehicle, 06 – Inattentive (Talking, Eating, Etc.), 07 – Improper Turn/Merge, 08 – Improper Passing, 09 – Wrong-Way Riding or Walking, 10 – Driving on Wrong Side of Road, 12 – Improper Crossing of Roadway or Intersection (Jaywalking), 13 – Failing to Have Lights on When Required, 14 – Operating Without Required Equipment, 15 – Improper or Erratic Lane Changing, 16 – Failure to Keep in Proper Lane or Running Off Road, 17 – Making Improper Entry to or Exit from Trafficway, 18 – Operating the Vehicle in other Erratic, Reckless, Careless or Negligent Manner, 19 – Not Visible (Dark clothing, No Lighting, etc.), 20 – Passing with Insufficient Distance or Inadequate Visibility or Failing to Yield to Overtaking Vehicle, 21 – Other, 98 – Not Reported, 99 – Unknown. • Format: select all that apply. • Added new remarks.
<p>New NM13</p>	<p>Non-Motorist Safety Equipment</p>	<p>X</p>	<p>X</p>	<ul style="list-style-type: none"> • Added new element. • Added new attributes: 0 – Not Applicable, 1 – None Used, 2 – Helmet, 4 – Protective Pads Used (elbows, knees, shins, etc.), 3 – Reflective Equipment/Clothing (jacket, backpack, etc.), 5 – Lighting, 7 – Other Safety Equipment, 8 – Not Reported, 9 – Unknown if Used. • Format: select all that apply. • Added new remarks.

ELEMENT #	ELEMENT NAME	NEW/REVISED VALUES	NEW/REVISED REMARKS	COMMENTS
New NM25	Related Factors – Person Level (Not a Motor Vehicle Occupant)	X	X	<ul style="list-style-type: none"> Added new element to form. Carry over from Related Factors – Person Level. Deleted attributes: 01 – Not Visible, 02 – Darting, Running or Stumbling Into Roadway, 03 – Improper Crossing of Roadway or Intersection, 04 – Walking/Riding With or Against Traffic, 05 – Interfering With Driver, 06 – Ill, Passed Out/Blackout, 07 – Emotional (e.g., Depression, Angry, Disturbed), 10 – Inattentive, 11 – Walking with Cane or Crutches, 12 – Restricted to Wheelchair, 14 – Impaired Due to Previous Injury, 15 – Under the Influence of Alcohol, Drugs or Medication, 16 – Blind, 17 – Other Physical Impairment, 19 – Pedestrian Jogging, 23 – Failure to Dim Lights or Have Lights on When Required, 24 – Operating Without Required Equipment, 27 – Improper or Erratic Lane Changing, 28 – Failure to Keep in Proper Lane, 29 – Illegal Driving on Road Shoulder, in Ditch, on Sidewalk or on Median, 30 – Making Improper Entry to or Exit from Trafficway, 32 – Opening Vehicle Closure into Moving Traffic or While Vehicle is in Motion, 33 – Passing Where Prohibited by Posted Signs, Pavement Markings, Hill or Curve, or School Bus Displaying Warning Not to Pass Line, 34 – Passing on Wrong Side, 35 – Passing with Insufficient Distance or Inadequate Visibility or Failing to Yield to Overtaking Vehicle, 36 – Operating the Vehicle in an Erratic, Reckless, Careless or Negligent Manner, 38 – Failure to Yield the Right of Way, 39 – Failure to Obey Actual Traffic Sign, 44 – Driving Too Fast for Conditions or in Excess of Posted Maximum, 45 – Driving Less Than Posted Minimum, 47 – Making Right Turn from Left Turn Lane, Left Turn from Right Turn Lane, 48 – Making Other Improper Turn, 49 – Driving Wrong Way on One Way Trafficway, 50 – Driving on Wrong Side of Road, 53 – Unfamiliar with

ELEMENT #	ELEMENT NAME	NEW/ REVISED VALUES	NEW/ REVISED REMARKS	COMMENTS
				<p>Roadway, 55 — Getting Off/Out of or On/In to a Transport Vehicle, 59 — Overcorrecting, 70 — Live Animals in Road, 87 — Police or Law Enforcement Officer, 88 — Seat Back Not in Normal Upright Position, Seat Back Reclined.</p> <ul style="list-style-type: none"> • Added new remarks.

New SAS Tables in 2010

Locator Code	2009 SAS Name	New 2010 SAS Names	Variable Name
C17	N/A	Cevent.AOI1	Area of Impact (this)
C17	N/A	Cevent.AOI2	Area of Impact (other)
C17	N/A	Cevent.EVENTNUM	Event Number
C17	N/A	Cevent.SOE	Sequence of Event
C2/V2/D2/P C2/P2/NM2	N/A	Cevent.ST_CASE	Consecutive Number
C1/V1/D1/P C1/P1/NM1	N/A	Cevent.STATE	State Number
C17	N/A	Cevent.VNUMBER1	Vehicle Number (this)
C17	N/A	Cevent.VNUMBER2	Vehicle Number (other)
C17	N/A	Vevent.AOI1	Area of Impact (this)
C17	N/A	Vevent.AOI2	Area of Impact (other)
C17	N/A	Vevent.EVENTNUM	The number of the first event in the crash in which this vehicle is involved (could be this vehicle or the other vehicle in the SAS event data set).
C17	N/A	Vevent.SOE	Sequence of Event
C2/V2/D2/P C2/P2/NM2	N/A	Vevent.ST_CASE	Consecutive Number
C1/V1/D1/P C1/P1/NM1	N/A	Vevent.STATE	State Number
C17	N/A	Vevent.VNUMBER1	Vehicle Number (this)
C17	N/A	Vevent.VNUMBER2	Vehicle Number (other)
V3/D3/PC3/ P3	N/A	Vevent.VEH_NO	Vehicle Number
New id variable	N/A	Vevent.VEVENUM	The number of event sequentially ordered for each vehicle.
C2/V2/D2/P C2/P2/NM2	N/A	Vsoe.ST_CASE	Consecutive Number
C1/V1/D1/P C1/P1/NM1	N/A	Vsoe.STATE	State Number
C17	N/A	Vevent.SOE	Sequence of Event
C17	N/A	Vsoe.AOI	Area of Impact associated with the event
New id variable	N/A	Vevent.VEVENUM	The number of event sequentially ordered for each vehicle.
V3/D3/PC3/ P3	N/A	Vsoe.VEH_NO	Vehicle Number

Locator Code	2009 SAS Name	New 2010 SAS Names	Variable Name
C17	N/A	Vsoe.EVENTNUM	The number of the first event in the crash in which this vehicle is involved (could be this vehicle or the other vehicle in the SAS event data set).
PB27	N/A	pdtype.PBCWALK	Marked Crosswalk Present
PB28	N/A	pdtype.PBSWALK	Side Walk Present
PB29	N/A	pdtype.PBSZONE	School Zone
PB30	N/A	pdtype.PEDCTYPE	Crash Type - Pedestrian
PB30B	N/A	pdtype.BIKECTYPE	Crash Type - Bike
PB31	N/A	pdtype.PEDLOC	Crash Location - Pedestrian
PB31B	N/A	ptype.BIKELOC	Crash Location - Bike
PB32	N/A	pdtype.PEDPOS	Pedestrian Position
PB32B	N/A	pdtype.BIKEPOS	Bike Position
PB33B	N/A	pdtype.PEDDIR	Pedestrian Direction
PB33B	N/A	pdtype.BIKEDIR	Bicyclist Direction
PB34	N/A	pdtype.MOTDIR	Motorist Direction
PB35	N/A	pdtype.MOTMAN	Motorist Maneuver
PB36	N/A	pdtype.PEDLEG	Intersection Leg
PB37	N/A	pdtype.PEDSNR	Pedestrian Scenario
PB38B	N/A	pdtype.PEDCGP	Pedestrian Crash Group
PB38B	N/A	pdtype.BIKECGP	Bike Crash Group
V3/D3/PC3/P3	N/A	pdtype.VEH_NO	Vehicle Number
P4/NM4	N/A	pdtype.PER_NO	Person Number
C2/V2/D2/P C2/P2/NM2	N/A	pdtype.ST_CASE	Consecutive Number
P7/NM7	N/A	pdtype.PBPTYPE	Person Type
C1/V1/D1/P C1/P1/NM1	N/A	pdtype.STATE	State
P5/NM5	N/A	pdtype.PBAGE	Age
P6/NM6	N/A	pdtype.PBSEX	Sex
V3/D3/PC3/P3	N/A	parkwork.VEH_NO	Vehicle Number & Unit Type

Locator Code	2009 SAS Name	New 2010 SAS Names	Variable Name
V5	N/A	parkwork.PTYPE	Unit Type
V9	N/A	parkwork.PMAKE	Vehicle Make
V10	N/A	parkwork.PMODEL	Vehicle Model
V11	N/A	parkwork.PBODYTYP	Body Type
V12	N/A	parkwork.PMODEL YR	Model Year
V13	N/A	parkwork.PVIN	VIN
V7	N/A	parkwork.PREG_STAT	Registration State
V22	N/A	parkwork.PSP_USE	Special Use
V23	N/A	parkwork.PEM_USE	Emergency use
V4	N/A	parkwork.PNUMOCCS	Number of Occupants
V14	N/A	parkwork.PTRAILER	Vehicle trailing
V34	N/A	parkwork.PFIRE	Fire Occurrence
V29	N/A	parkwork.PVEH_SEV	Extent of damage
V30	N/A	parkwork.PTOWED	Vehicle Removal
V28	N/A	parkwork.PIMPACT1	Area of Impact- Initial Damaged
V28	N/A	parkwork.PIMPACT2	Area of Impact- Most Damaged
V19	N/A	parkwork.PCargTyp	Cargo body type
V20 - HM1	N/A	parkwork.PHAZ_INV	Hazardous Material Involvement/Placard - Involvement
V20 - HM2	N/A	parkwork.PHAZPLAC	Hazardous Material Involvement/Placard - Placard
V20 - HM3	N/A	parkwork.PHAZ_ID	Hazardous Material Involvement/Placard - Identification Number
V20 - HM4	N/A	parkwork.PHAZ_CNO	Hazardous Material Involvement/Placard - Class Number
V20 - HM5	N/A	parkwork.PHAZ_REL	Hazardous Material Involvement/Placard - Released
V100	N/A	parkwork.MAK_MOD	Make Model
V21	N/A	parkwork.PBUS_USE	Bus Use
C8	N/A	parkwork.PDAY	Day
V150	N/A	parkwork.PDEATHS	Fatals in Vehicle
V121	N/A	parkwork.PFUECODE	Fuel Code

Locator Code	2009 SAS Name	New 2010 SAS Names	Variable Name
V17	N/A	parkwork.PGVWR	GVWR
C18	N/A	parkwork.PHARM_EV	First Harmful Event
V6	N/A	parkwork.PHIT_RUN	Hit and Run
C9	N/A	parkwork.PHOUR	Crash Time (HOUR)
V124	N/A	parkwork.PMCYCL_DS	Motorcycle Engine Displacement (CC)
V16A	N/A	parkwork.PMCARR_I1	MCID Issuing Authority
V16	N/A	parkwork.PMCARR_I2	MCID Identification Number
V16B	N/A	parkwork.PMCARR_ID	Motor Carrier Identification Number
V32	N/A	parkwork.PM_HARM	Most Harmful Event
C19	N/A	parkwork.PMAN_COLL	Manner of Collision
C9	N/A	parkwork.PMINUTE	Crash Time (MINUTE)
C8	N/A	parkwork.PMONTH	Crash Date (Month)
V8	N/A	parkwork.POWNER	Registered Vehicle Owner
V122	N/A	parkwork.PSER_TR	VIN Truck Series
V25	N/A	parkwork.PUNDERIDE	Underride/Override
C4AA	N/A	parkwork.PVE_FORMS	Number of Vehicle Forms Submitted for MV In Transport
V13	N/A	parkwork.PVIN	Vehicle Identification Number
V101	N/A	parkwork.PVIN_1	VIN Character 1
V102	N/A	parkwork.PVIN_2	VIN Character 2
V103	N/A	parkwork.PVIN_3	VIN Character 3
V104	N/A	parkwork.PVIN_4	VIN Character 4
V105	N/A	parkwork.PVIN_5	VIN Character 5
V106	N/A	parkwork.PVIN_6	VIN Character 6
V107	N/A	parkwork.PVIN_7	VIN Character 7
V108	N/A	parkwork.PVIN_8	VIN Character 8
V109	N/A	parkwork.PVIN_9	VIN Character 9
V110	N/A	parkwork.PVIN_10	VIN Character 10

Locator Code	2009 SAS Name	New 2010 SAS Names	Variable Name
V111	N/A	parkwork.PVIN_11	VIN Character 11
V112	N/A	parkwork.PVIN_12	VIN Character 12
V115	N/A	parkwork.PVINA_MOD	VIN Model
V114	N/A	parkwork.PVINMAKE	VIN Make
V117	N/A	parkwork.PVINMODYR	VIN Model Year
V113	N/A	parkwork.PVINTYPE	VIN Vehicle Type
V116	N/A	parkwork.PVIN_BT	VIN Body Type
V125	N/A	parkwork.PVIN_LNGT	VIN Length
V118	N/A	parkwork.PVIN_WGT	Curb Weight
V18	N/A	parkwork.PV_CONFIG	Vehicle Configuration
V33	N/A	parkwork.PVEH_CF1	Related Factors -1
V33	N/A	parkwork.PVEH_CF2	Related Factors -2
V123	N/A	parkwork.PWGTCD_TR	Truck Weight Rating
V120	N/A	parkwork.PWHLBS_LG	Wheelbase Long
V119	N/A	parkwork.PWHLBS_SH	Wheelbase Short
C1/V1/D1/P C1/P1/NM1	N/A	parkwork.STATE	State Number
C2/V2/D2/P C2/P2/NM2	N/A	parkwork.ST_CASE	Consecutive Number
V3/D3/PC3/ P3	N/A	parkwork.VEH_NO	Vehicle Number
PC16	N/A	distract.MDRDSTRD	Driver Distracted By
C2/V2/D2/P C2/P2/NM2	N/A	distract.ST_CASE	Consecutive Number
C1/V1/D1/P C1/P1/NM1	N/A	distract.STATE	State Number
V3/D3/PC3/ P3	N/A	distract.VEH_NO	Vehicle Number
PC4	N/A	factor.MFACTOR	Contributing Circumstances, Motor Vehicle
C2/V2/D2/P C2/P2/NM2	N/A	factor.ST_CASE	Consecutive Number
C1/V1/D1/P C1/P1/NM1	N/A	factor.STATE	State Number
V3/D3/PC3/ P3	N/A	factor.VEH_NO	Vehicle Number

Locator Code	2009 SAS Name	New 2010 SAS Names	Variable Name
NM14	N/A	impair.MFACTOR	Condition (Impairment) at Time of Crash
C2/V2/D2/P C2/P2/NM2	N/A	impair.ST_CASE	Consecutive Number
C1/V1/D1/P C1/P1/NM1	N/A	impair.STATE	State Number
V3/D3/PC3/ P3	N/A	impair.VEH_NO	Vehicle Number
PC15	AVOID	maneuver.MDRMANAV	Driver Maneuvered to Avoid
C2/V2/D2/P C2/P2/NM2	N/A	maneuver.ST_CASE	Consecutive Number
C1/V1/D1/P C1/P1/NM1	N/A	maneuver.STATE	State Number
V3/D3/PC3/ P3	N/A	maneuver.VEH_NO	Vehicle Number
NM12	N/A	Nmcrash.MTM_CRSH	Non Motorists Action/Circumstance at Time of Crash
C2/V2/D2/P C2/P2/NM2	N/A	Nmcrash.ST_CASE	Consecutive Number
C1/V1/D1/P C1/P1/NM1	N/A	Nmcrash.STATE	State Number
V3/D3/PC3/ P3	N/A	Nmcrash.VEH_NO	Vehicle Number
NM11	N/A	nmprior.MPR_ACT	Non Motorists Action/Circumstance Prior to Crash
C2/V2/D2/P C2/P2/NM2	N/A	nmprior.ST_CASE	Consecutive Number
C1/V1/D1/P C1/P1/NM1	N/A	nmprior.STATE	State Number
V3/D3/PC3/ P3	N/A	nmprior.VEH_NO	Vehicle Number
NM13	N/A	safetyeq.MSAFEQMT	Non Motorists Safety Equipment
C2/V2/D2/P C2/P2/NM2	N/A	safetyeq.ST_CASE	Consecutive Number
C1/V1/D1/P C1/P1/NM1	N/A	safetyeq.STATE	State Number
V3/D3/PC3/ P3	N/A	safetyeq.VEH_NO	Vehicle Number
D21	N/A	violatn.MSAFEQMT	Violations Charged
C2/V2/D2/P C2/P2/NM2	N/A	violatn.ST_CASE	Consecutive Number
C1/V1/D1/P C1/P1/NM1	N/A	violatn.STATE	State Number
V3/D3/PC3/ P3	N/A	violatn.VEH_NO	Vehicle Number
PC14	D_VISION1, D_VISION2, D_VISION3	vision.MVISOBSC	Driver's Vision Obscured By
C2/V2/D2/P C2/P2/NM2	N/A	vision.ST_CASE	Consecutive Number

Locator Code	2009 SAS Name	New 2010 SAS Names	Variable Name
C1/V1/D1/P C1/P1/NM1	N/A	vision.STATE	State Number
V3/D3/PC3/ P3	N/A	vision.VEH_NO	Vehicle Number

Summary of the SAS Naming Changes in 2010

Locator Code	2009 SAS Name	New 2010 SAS Names	Variable Name
C20a	REL_JUNC	RELJCT1	Relation to Junction - Within Interchange Area
C20b	N/A	RELJCT2	Relation to Junction - Specific Location
PC5	TRAF_FLO	VTRAFWAY	Trafficway Description
PC6	NO_LANES	VNUM_LAN	Total Lanes in Roadway
PC7	SP_LIMIT	VSPD_LIM	Speed Limit
PC8	ALIGNMNT	VALIGN	Roadway Alignment
PC9	PROFILE	VPROFILE	Roadway Grade
PC10	PAVE_TYP	VPAVETYP	Roadway Surface Type
PC11	SUR_COND	VSURCOND	Roadway Surface Condition
PC12	TRA_CONT	VTRAFCON	Traffic Control Device
PC13	T_CONT_F	VTCONT_F	Traffic Control Device Functioning
C21	N/A	TYP_INT	Type of Intersection
D6	DR_ZIP	DZIPCODE	Driver's Zip Code
V113	N/A	VINTYPE	VIN Vehicle Type
V114	N/A	VINMAKE	VIN Make
V117	N/A	VINMODYR	VIN Model Year
V12	MOD_YEAR	MODEL_YR	Model Year
V15	J_KNIFE	JACKKNIFE	Jackknife
P23	N/A	ACC_TYPE	Accident Type
V121	N/A	FUELCODE	Fuel Code
V126	N/A	TIRE_SZE	Original Tire Size
V127	N/A	DISPLACE	Cubic Inch Displacement
V128	N/A	CYLINDER	Number of Cylinders
V129	N/A	CARBUR	Carburetion
V130	N/A	WHLDRWHL	Number of wheels/driver wheels

Locator Code	2009 SAS Name	New 2010 SAS Names	Variable Name
V131	N/A	TON_RAT	Ton Rating
V132	N/A	TRK_WT	Shipping Weight
V133	N/A	TRKWTVAR	Shipping Weight Variance
V134	N/A	VIN_REST	VIN Restraint Type
V135	N/A	MCYCL_WT	Dry Weight
V136	N/A	MCYCL_CY	Number of Engine Cycles
P11	N/A	REST_MIS	Any Indication of Mis-Use of Restraint System/Helmet Use

The variables in RED are new to 2010 FARS.
The variables in BLUE are changed in 2010 FARS.

Trafficway Descriptor Data Elements 2010

As part of the data standardization effort to harmonize the data in FARS and NASS GES and align both systems with the data elements recommended in MMUCC, nine data elements were moved from the Crash Level in FARS to the a new Precrash Level method of collection. Some data elements also had title changes as a result. The changes are identified below with ***bold/italics***. Those data elements are:

2009 Crash Level Data Elements	2010 Precrash Level Data Elements
C21 Trafficway Flow (TRAF_FLO)	PC5 Trafficway <i>Description</i> (VTRAFWAY)
C22 Number of Travel Lanes (NO_LANES)	PC6 <i>Total Lanes in Roadway</i> (VNUM_LAN)
C23 Speed Limit (SP_LIMIT)	PC7 Speed Limit (VSPD_LIM)
C24 Roadway Alignment (ALIGNMNT)	PC8 Roadway Alignment (VALIGN)
C25 Roadway Profile (PROFILE)	PC9 Roadway <i>Grade</i> (VPROFILE)
C26 Roadway Surface Type (PAVE_TYP)	PC10 Roadway Surface Type (VPAVETYP)
C27 Roadway Surface Condition (SUR_COND)	PC11 Roadway Surface Condition (VSURCOND)
C29 Traffic Control Device (TRAF_CON)	PC12 Traffic Control Device (VTRAFCON)
C30 Traffic Control Device Functioning (T_CONT_F)	PC13 Traffic Control Device Functioning (VTCONT_F)

In the FARS data collection years 2009 and prior, the set of elements above-left (C21-C27) provided details about the characteristics of the trafficway to which the crash had been assigned. Crashes were assigned to the trafficway on which the First Harmful Event occurred. If the First Harmful Event occurred outside the boundaries of a trafficway (e.g. private property), the crash was assigned to the trafficway on which the vehicle was traveling when the Unstabilized Situation began.

In at-intersection crashes, assignment was to the highest function class of trafficway at the intersection. If the vehicles were traveling on two different trafficways of equal function class prior to an at-intersection crash, it was assigned to the trafficway on which the motor vehicle precipitating the crash was traveling.

The data elements C29 Traffic Control Device and C30 Traffic Control Device Functioning were coded with respect to the control most applicable to the crash. If more than one device was present, the highest device (lowest number on the attribute list) most related to the crash was selected.

In the FARS data collection years starting in 2010, this set of elements above-right (PC5-PC13) provide details about the characteristics of the trafficway that each in-transport motor vehicle was traveling on just prior to its Critical Precrash Event. The Critical Precrash Event is the event which made the crash imminent (i.e., something occurred which made the collision possible). For vehicles departing the trafficway prior to their critical precrash events, the trafficway selected for classification is the one the vehicle departed. If this vehicle is in a junction

just prior to its critical precrash event, the trafficway selected for classification is the one it is on before entering the junction.

While these data elements are still collecting the same general information in 2010, there are some important differences to note. First, by being collected for each vehicle, different trafficway characteristics may be recorded for each vehicle in the crash. Second, in some circumstances the procedural change to being recorded for each vehicle based on its precrash location rather than the location of the first harmful event will result in different data being provided than would have been in the same crash in prior years.

The types of crashes most affected by the change are those that occur in junction. For example, in a crash where two vehicles are traveling on the same trafficway in opposite directions (e.g. North-South) that have an at-intersection crash in the junction of a higher function class trafficway, the characteristics of the lower class trafficway that each of the vehicles were traveling on before entering the intersection area will be recorded in the data elements PC5-PC13 for each vehicle. In prior years, the characteristics of the higher functional class trafficway would have appeared on the Crash Level. Also note that in such a case, on the Crash Level this crash would still be recoded to the higher functional class trafficway in the data elements C10 National Highway System, C11 Roadway Function Class, C12 Route Signing, and C13 Trafficway Identifier and none of the vehicle level characteristics can be attributed to this trafficway.

Preface

The purpose of this analytical guide is to introduce the historical coding practices of the Fatality Analysis Reporting System (FARS) from 1975 to 2010. In other words, this guide presents the evolution of FARS coding from inception through 2010.

FARS is a census of fatal motor vehicle crashes with, a set of data files documenting all qualifying fatalities that occurred within the 50 States, the District of Columbia, and Puerto Rico since 1975. To qualify as a FARS case, the crash had to involve a motor vehicle traveling on a traffic way customarily open to the public, and must have resulted in the death of a motorist or a non-motorist within 30 days of the crash.

The coding manual provides a set of written instructions on how to transfer the information from a police accident/crash report (PAR) to the FARS data. To augment the coding manual, classes are held each year to train the coders, and a system wide FARS meeting is held to reinforce uniform coding practices. An unsuspecting analyst might assume that if one had a complete set of coding manuals and sufficient diligence, one could produce the desired results. Unfortunately, the data in the current files available for analysis do not correspond with the historical coding manuals.

A comprehensive coding manual has been produced each year and undergone various changes. In order to ensure accuracy, each variable of interest must be checked in each year's coding manual when doing analysis across years.

A complete set of consistent coding manuals, unfortunately, does not organize the data for the purpose of analysis. A data analyst may need the FARS data functionally organized. Data users need to know what data are available and how to access them. The data was organized into multiple files, the most important being the accident, person and vehicle files. However, due to the standardization of FARS and the National Automotive Sampling System General Estimates System (NASS GES), the data has been structured into 16 data sets as of 2010. The increase in the number of data files is a direct result of NHTSA's enhanced data collection efforts and obtaining additional crash information.

Along with the new data sets, you will notice this reference guide has undergone a transformation. We believe this new format is more user-friendly and provides a better historical overview of each data element and how it has evolved over time.

The compilation of FARS data for three decades has been an outstanding accomplishment. These data store valuable information that have been preserved over time and are available for present and future use. This analytic reference guide should help improve the usefulness and accessibility of the FARS data. With the exception of personal notes, there is no reason to keep older versions of this reference guide. All information in earlier editions has been retained in this newer version.

Thank you for your interest in highway traffic safety.

FARS Operations

The Fatality Analysis Reporting System (FARS), which became operational in 1975, contains data on a census of fatal traffic crashes within the 50 States, the District of Columbia, and Puerto Rico. To be included in FARS, a crash must involve a motor vehicle traveling on a trafficway customarily open to the public, and must result in the death of an occupant of a vehicle or a non-occupant within 30 days (720 hours) of the crash.

NHTSA has a cooperative agreement with an agency in each State's government to provide information on all qualifying fatal crashes in the State. These agreements are managed by Regional Contracting Officer's Technical Representatives located in the 10 NHTSA Regional Offices. Trained State employees, called "FARS Analysts," are responsible for gathering, translating, and transmitting their State's data to NCSA in a standard format. The number of analysts varies by State.

FARS data are obtained from various States' documents, such as:

- Police Accident Reports
- Death Certificates
- State Vehicle Registration Files
- Coroner/Medical Examiner Reports
- State Driver Licensing Files
- Hospital Medical Reports
- State Highway Department Data
- Emergency Medical Service Reports
- Vital Statistics
- Other State Records

From these documents, the analysts code more than 100 FARS data elements. The specific data elements may be modified slightly each year to conform to changing user needs, vehicle characteristics, and highway safety emphasis areas. The data collected within FARS do not include any personal identifying information, such as names, addresses, or social security numbers. Thus, any data kept in FARS files and made available to the public fully conform to the Privacy Act.

Each analyst enters data which is automatically checked when entered for acceptable range values and for consistency, enabling the analyst to make corrections immediately. Several programs continually monitor and improve the completeness and accuracy of the data.

FARS Instructions

Historically, this reference guide covered the Accident, Vehicle and Person files however; the year 2010 introduces several new datasets. This analytical guide reviews the 16 data sets that are presented in the 2010 SAS files. These files are: Accident, Vehicle, Parkwork, Person, Cevent, Vevent, PBType, Distract, Factor, Impair, Maneuver, NMPrior, NMCrash, Safetyeq, Violatn and the Vision datasets. The following datasets: Distract, Factor, Impair, Maneuver, NMPrior, NMCrash, Safetyeq, Violation and Vision contain variables in which the analyst could code multiple responses. Hence, if you review the 2010 Coding and Editing Manual these same variables are select all that apply. The Cevent dataset details the sequence of events in the crash, whereas the Vevent dataset details the events of the crash per vehicle.

To assist in your understanding of the new reference guide, we will discuss the new layout and what you will see in the upcoming pages. For each of the variables, a brief definition is provided along with any additional information which could assist analyses. We have also provided the SAS name(s) for the variables and attributes in chronological order (i.e., the oldest items first). This guide also has documentation on variables that appear in multiple datasets. The variables Trafficway Description, Total Lanes in Roadway, Roadway Alignment, Roadway Profile, Roadway Surface Type, Roadway Surface Condition, Traffic Control Device, Traffic Control Device Functioning, and Speed Limit appear on both the Accident and Vehicle files. For these elements, SAS names have been changed on the Accident File to denote that the variables were initially coded at the Vehicle level and subsequently derived at the Accident level.

For any variable critical to the analysis being conducted, it is good practice to examine the variable by State.

FARS SAS Data Sets

FARS data are made available to the public in SAS data sets. Over the years changes have been made to the type of data collected and the way the data are presented in the SAS data sets. Some variables have been dropped and new ones added, coding of individual variables has changed, and new SAS data sets have been created. Coding changes and the years for which they are applicable are shown in the “Variable Definitions and Codes” section of this document. The FARS Coding and Editing Manual contain a detailed description of each SAS variables including coding instructions and attribute definitions. The Coding Manual is published for each year of data collection. Years 2001 to current are available at:

<http://www-nrd.nhtsa.dot.gov/Cats/listpublications.aspx?Id=J&ShowBy=DocType>

Note: In this manual the word vehicle means in transport motor vehicle unless otherwise noted.

The SAS data sets and years of availability are:

- **Accident** - (1975-current): This data set contains information about crash characteristics and environmental conditions at the time of the crash. There is one record per crash.
- **Vehicle** - (Changed in 2010): This data set contains information describing the (in-transport) motor vehicles and the drivers of in-transport motor vehicle who are involved in the crash. There is one record per in-transport motor vehicle. Parked and working vehicle information is in the Parkwork data set.
- **Person** - (1975-current): This data set contains information describing all persons involved in the crash including motorists (i.e., drivers and passengers of in-transport motor vehicles) and non-motorists (e.g., pedestrians and pedalcyclists). It provides information such as age, sex, and vehicle occupant restraint use and injury severity. There is one record per person.
- **Cevent** – (New in 2010): Information for all of the qualifying events (both harmful and non-harmful) which occurred in the crash are included in this data set. There is one record per event. For each in-transport motor vehicle, the event number of its most harmful event is stored in the Vehicle data set. This data set details the chronological sequence of events resulting from an unstabilized situation that constitutes a motor vehicle traffic crash.
- **Vevent** – (New in 2010): This data set contains the sequence of events for each motor vehicle involved in the crash. Included are the event numbers, non-harmful events (e.g., ran off road-right, crossed center line), objects struck and areas of impact. There is one record for each harmful and non-harmful event in which the vehicle is involved.
- **Vsoe** – (New in 2010): This data set contains the sequence of events for each motor vehicle involved in the crash. Included are the event numbers, non-harmful events (e.g., ran off road-right, crossed center line), objects struck and areas of impact. There is one record for each harmful and non-harmful event in which the vehicle is involved. It is simplified Vevent table.
- **Factor** - (New in 2010): This data set contains information about vehicle circumstances which may have contributed to the crash. There is at least one record per in-transport motor vehicle. Each factor is coded on a separate record.

- **Violatn** - (*New in 2010*): This data set contains information about violations which were charged to drivers. There is at least one record per in-transport motor vehicle. Each violation is coded on a separate record.
- **Vision** - (*New in 2010*): This data set contains information about circumstances which may have obscured the driver's vision. There is at least one record per in-transport motor vehicle. Each obstruction is coded on a separate record.
- **Maneuver** - (*New in 2010*): This data set contains information about actions taken by the driver to avoid something or someone in the road. There is at least one record per in-transport motor vehicle. Each maneuver is coded on a separate record.
- **Distract** - (*New in 2010*): This data set contains information about driver distractions. There is at least one record per in-transport motor vehicle. Each distraction is coded on a separate record.
- **Drimpair** - (*New in 2010*): This data set contains information about physical impairments of drivers of motor vehicles. There is one record per impairment and there is at least one record for each driver of an in-transport motor vehicle.
- **Nmimpair** - (*New in 2010*): This data set contains information about physical impairments of people who are not occupants of motor vehicles. There is one record per impairment and there is at least one record for each person who is not an occupant of a motor vehicle.
- **Nmcrash** - (*New in 2010*): This data set contains information about any improper actions of people who are not occupants of motor vehicles (e.g., pedestrians and bicyclists) or contributing circumstances noted on the PAR. There is one record per action and there is at least one record for each person who is not an occupant of a motor vehicle.
- **Nmprior** - (*New in 2010*): This data set contains information about what people who are not occupants of motor vehicles (e.g., pedestrians and bicyclists) are doing prior to the crash. There is one record per action and there is at least one record for each person who is not an occupant of a motor vehicle.
- **Safetyeq** - (*New in 2010*): This data set contains information about safety equipment used by people who are not occupants of motor vehicles. There is one record per equipment item, and there is at least one record for each person who is not an occupant of a motor vehicle.
- **Vehnit** - (*2005-2009, changed in 2010*): This data set contains information about parked and working vehicles that were involved in FARS crashes. Prior to the Vehnit creation, the vehicles Not-In-Transport were not included in the FARS data. This data set had the same list of variables and SAS structure as the Vehicle data set where the UNITYTYPE of the vehicle is 2, 3, or 4. The vehicle data set will have the vehicles in transport where the UNITYTYPE of the vehicle is 1. Beginning in 2010, FARS has discontinued the Vehnit data set and introduced the new Parkwork data set.
- **Parkwork** - (*New in 2010*): This data set contains information about parked and working vehicles that were involved in FARS crashes. A parked vehicle is a motor vehicle which is stopped off the roadway. A working vehicle is used to indicate that this is a motor vehicle that was in the act of performing highway construction, maintenance or utility work related to the trafficway when it became an involved in the crash. Data users are strongly advised to consult the annual FARS Coding and Editing Manuals for a detailed description.

- **Pbtype** - (*New in 2010*): This data set contains information about circumstances related to pedestrians and bicyclists involved in the crash. There is one record for each pedestrian, bicyclist or person on a personal conveyance.

FARS Variable List

The following lists all SAS variables with their SAS data set locations.

VARIABLE LIST

C1/V1/D1/PC1/P1/NM1	State Number	STATE	59
C2/V2/D2/PC2/P2/NM2	Consecutive Number	ST_CASE	60
V3/D3/PC3/P3/NM4	Vehicle Number	VEH_NO	61
P4/NM3	Person Number	PER_NO	62
C17	Event Number	EVENTNUM	63
<i>The ACCIDENT Data Set 64</i>			
C3	Number of Forms Submitted for Persons Not in Motor Vehicles	PEDS	65
C4	Number of Vehicle Forms Submitted - ALL	VE_TOTAL	66
C4AA	Derived Number of Vehicle Forms Submitted for Motor Vehicle in Transport	VE_FORMS	67
C5	Number of Motor Vehicle Occupant Forms Submitted	PERSONS	68
C6	County	COUNTY	69
C7	City	CITY	70
C8A	Month of Crash	MONTH	71
C8B	Day of Crash	DAY	71
C8C	Day of Week	DAY_WEEK	72
C8D	Year of Crash	YEAR	72
C9A	Hour of Crash	HOUR	73
C9B	Minute of Crash	MINUTE	73
C10	National Highway System	NHS	74
C11	Roadway Function Class	ROAD_FNC	75
C12	Route Signing	ROUTE	77
C13	Trafficway Identifier	TWAY_ID	78
C13	Trafficway Identifier	TWAY_ID2	78
C14	Milepoint	MILEPT	79
C15A	Latitude	LATITUDE	80
C15B	Longitude	LONGITUD	81
C16	Special Jurisdiction	SP_JUR	82
C18	First Harmful Event	HARM_EV	83

C19	Manner of Collision	MAN_COLL	87
C20A	Relation to Junction- Within Interchange Area	RELJCT1	88
C20B	Relation to Junction- Specific Location	RELJCT2	88
C21	Type of Intersection	TYP_INT	90
C22	Relation to Trafficway	REL_ROAD	91
C23	Work Zone	WRK_ZONE	92
C24	Light Condition	LGT_COND	93
C25	Atmospheric Conditions	WEATHER	94
C25	Atmospheric Conditions	WEATHER1	94
C25	Atmospheric Conditions	WEATHER2	94
C26	School Bus Related	SCH_BUS	96
C27	Rail Grade Crossing Identifier	RAIL	97
C28A	Hour of Notification	NOT_HOUR	98
C28B	Minute of Notification	NOT_MIN	98
C29A	Hour of Arrival at Scene	ARR_HOUR	99
C29B	Minute of Arrival at Scene	ARR_MIN	99
C30A	Hour of EMS Arrival at Hospital	HOSP_HR	100
C30B	Minute of EMS Arrival at Hospital	HOSP_MIN	100
C31	Related Factors- Crash Level	CF1	101
C31	Related Factors- Crash Level	CF2	101
C31	Related Factors- Crash Level	CF3	101
C100	Drunk Driver	DRUNK_DR	103
C101	Fatalities	FATALS	104
PC13	Traffic Control Device Functioning	DTCONT_F	114

The VEHICLE Data Set **115**

V4	Number of Occupants	NUMOCCS	116
V5	Unit Type	UNITTYPE	117
V6	Hit and Run	HIT_RUN	118
V7	Registration State	REG_STATE	119
V8	Registered Vehicle Owner	OWNER	121
V9	Vehicle Make	MAKE	122
V10	Vehicle Model (listed with Vehicle Make)	MODEL	127
V11	Body Type	BODY_TYP	129
V12	Vehicle Model Year	MOD_YEAR	134
V13	Vehicle Identification Number (VIN)	VIN	135
V14	Vehicle Trailing	TOW_VEH	136
V15	Jackknife	J_KNIFE	137
V16	Motor Carrier Identification Number	MCARR_ID	138
V16A	MCID Issuing Authority	MCARR_I1	139

V16B	MCID Identification Number	MCARR_I2	140
V17	Gross Vehicle Weight Rating/ GCWR	GVWR	141
V18	Vehicle Configuration	V_CONFIG	142
V19	Cargo Body Type	CARGO_BT	143
V20A/HM1	Hazardous Material Involvement	HAZ_INV	145
V20B/HM2	Hazardous Material Placard	HAZ_PLAC	145
V20C/HM3	Hazardous Material Identification Number	HAZ_ID	145
V20D/HM4	Hazardous Material Class Number	HAZ_CNO	146
V20E/HM5	Release of Hazardous Material from the Cargo Compartment	HAZ_REL	146
V21	Bus Use	BUS_USE	148
V22	Special Use	SPEC_USE	149
V23	Emergency Use	EMER_USE	150
V24	Travel Speed	TRAV_SP	151
V25	Underride/Override	UNDERIDE	152
V26	Rollover	ROLLOVER	153
V27	Location of Rollover	ROLINLOC	154
V28A	Initial Damage Area	IMPACT1	155
V28B	Most Damaged Area	IMPACT2	156
V29	Extent of Damage	DEFORMED	157
V30	Vehicle Removal	TOWED	158
V31	Sequence of Events	SEQ1	159
V31	Sequence of Events	SEQ2	159
V31	Sequence of Events	SEQ3	159
V31	Sequence of Events	SEQ4	159
V31	Sequence of Events	SEQ5	159
V31	Sequence of Events	SEQ6	159
V32	Most Harmful Event	M_HARM	161
V33	Related Factors- Vehicle Level	VEH_SC1	165
V33	Related Factors- Vehicle Level	VEH_SC2	165
V34	Fire Occurrence	FIRE_EXP	167
V100	Make Model Combined	MAK_MOD	168
V101	VIN Character 1	PVIN1	169
V102	VIN Character 2	PVIN2	170
V103	VIN Character 3	PVIN3	171
V104	VIN Character 4	PVIN4	172
V105	VIN Character 5	PVIN5	173
V106	VIN Character 6	PVIN6	174
V107	VIN Character 7	PVIN7	175
V108	VIN Character 8	PVIN8	176
V109	VIN Character 9	PVIN9	177

V110	VIN Character 10	PVIN10	178
V111	VIN Character 11	PVIN11	179
V112	VIN Character 12	PVIN12	180
V113	VIN Vehicle Type	VINTYPE	181
V114	VIN Make	VINMAKE	182
V115	VIN Model	VINA_MOD	183
V116	VIN Body Type	VIN_BT	184
V117	VIN Model Year	VINMODYR	188
V118	Curb Weight	VIN_WGT	189
V119	Wheelbase Short	WHLBS_SH	190
V120	Wheelbase Long	WHLBS_LG	191
V121	Fuel Code	FUELCODE	192
V122	VIN Truck Series	SER_TR	193
V123	Truck Weight Rating	WGTCDD_TR	194
V124	Motorcycle Engine Displacement (CC)	MCYCL_DS	195
V125	VIN Length	VIN_LNGT	196
V150	Fatalities in Vehicle (Number)	DEATHS	197
V151	Driver Drinking	DR_DRINK	198
D4	Driver Presence	DR_PRES	199
D5	Driver's License State	L_STATE	200
D6	Driver's ZIP Code	DR_ZIP	201
D7A	Non-CDL License Type	L_TYPE	202
D7B	Non-CDL License Status	L_STATUS	202
D8	Commercial Motor Vehicle License Status	CDL_STAT	204
D9	Compliance with CDL Endorsements	L_ENDORS	205
D10	License Compliance with Class of Vehicle	L_COMPL	206
D11	Compliance with License Restrictions	L_RESTRI	207
D12	Driver Height	DR_HGT	208
D13	Driver Weight	DR_WGT	209
D14	Previous Recorded Crashes	PREV_ACC	210
D15	Previous Recorded Suspensions and Revocations	PREV_SUS	211
D16	Previous DWI Convictions	PREV_DWI	212
D17	Previous Speeding Convictions	PREV_SPD	213
D18	Previous Other Harmful Moving Violation Convictions	PREV_OTH	214
D19A	Month	FIRST_MO	215
D19B	Year	FIRST_YR	215

D20A	Month	LAST_MO	216
D20B	Year	LAST_YR	216
D22	Speed Related	SPEEDREL	220
D24	Related Factors- Driver Level	DR_SF1	221
D24	Related Factors- Driver Level	DR_SF2	221
D24	Related Factors- Driver Level	DR_SF3	221
D24	Related Factors- Driver Level	DR_SF4	221
PC5	Trafficway Description	VTRAFWAY	227
PC6	Total Lanes in Roadway	VNUM_LAN	228
PC7	Speed Limit	VSPD_LIM	229
PC8	Roadway Alignment	VALIGN	230
PC9	Roadway Grade	VPROFILE	231
PC10	Roadway Surface Type	VPAVETYP	232
PC11	Roadway Surface Condition	VSURCOND	233
PC12	Traffic Control Device	VTRAFCON	234
PC13	Traffic Control Device Functioning	VTCONT_F	235
PC17	Pre-Event Movement (Prior To Recognition of Critical Event)	P_CRASH1	237
PC19	Critical Event- Pre-Crash (Event)	P_CRASH2	238
PC20	Attempted Avoidance Maneuver	P_CRASH3	240
PC21	Pre-Impact Stability	PCRASH4	242
PC22	Pre-Impact Location	PCRASH5	243
PC23	Crash Type	ACC_TYPE	244
<i>The PERSON Data Set</i>			251
P5/NM5	Age	AGE	252
P6/NM6	Sex	SEX	253
P7/NM7	Person Type	PER_TYP	254
P8/NM8	Injury Severity	INJ_SEV	256
P9	Seating Position	SEAT_POS	257
P10	Restraint System/Helmet Use	REST_USE	259
P11	Indication of Misuse of Restraint System/Helmet	REST_MIS	261
P12	Air Bag Deployed	AIR_BAG	262
P13	Ejection	EJECTION	264
P14	Ejection Path	EJ_PATH	265
P15	Extrication	EXTRICAT	266
P16/NM15	Police Reported Alcohol Involvement	DRINKING	267
P17/NM16	Method of Alcohol Determination by Police	ALC_DET	268
P18A/NM17A	Alcohol Test Status	ALC_STATUS	269
P18B/NM17B	Alcohol Test Type	ATST_TYP	270

P18C/NM17C	Alcohol Test Result	ALC_RES	271
P19/NM18	Police Reported Drug Involvement	DRUGS	272
P20/NM19	Method of Drug Determination by Police	DRUG_DET	273
P21A/NM20A	Drug Test Status	DSTATUS	274
P21B/NM20B	Drug Test Type	DRUGTST1	275
P21B/NM20B	Drug Test Type	DRUGTST2	275
P21B/NM20B	Drug Test Type	DRUGTST3	275
P21C/NM20C	Drug Test Results	DRUGRES1	276
P21C/NM20C	Drug Test Results	DRUGRES2	276
P21C/NM20C	Drug Test Results	DRUGRES3	276
P22/NM21	Transported to Medical Facility By	HOSPITAL	278
P23/NM22	Died at Scene/En Route	DOA	279
P24A/NM23A	Month of Death	DEATH_MO	280
P24B/NM23B	Day of Death	DEATH_DA	280
P24C/NM23C	Year of Death	DEATH_YR	281
P25/NM24	Death Time	DEATH_TM	282
P25A/NM24A	Hour of Death	DEATH_HR	282
P25B/NM24B	Minute of Death	DEATH_MN	283
P100A	Lag Hours	LAG_HRS	284
P100B	Lag Minutes	LAG_MINS	284
P26/NM25	Related Factors- Person Level	P_SF1	285
P26/NM25	Related Factors- Person Level	P_SF2	285
P26/NM25	Related Factors- Person Level	P_SF3	285
SP1	Death Certificate Number	CERT_NO	292
SP2	Fatal Injury at Work	WORK_INJ	293
SP3A	Race	RACE	294
SP3B	Hispanic Origin	HISPANIC	295
NM4	Number of Motor Vehicle Striking Non-Motorist	N_MOT_NO	296
NM10	Non-Motorist Location at Time of Crash	LOCATION	297
<i>The CEVENT Data Set</i>			299
C17	Vehicle Number (This Vehicle)	VNUMBER1	300
C17	Area of Impact (This Vehicle)	AOI1	301
V31	Sequence of Events	SOE	302
C17	Vehicle Number (Other Vehicle)	VNUMBER2	304
C17	Area of Impact (Other Vehicle)	AOI2	305
<i>The VEVENT Data Set</i>			306
C17	Vehicle Number (This Vehicle)	VNUMBER1	307
C17	Area of Impact (This Vehicle)	AOI1	308

V31	Sequence of Events	SOE	309
C17	Vehicle Number (Other Vehicle)	VNUMBER2	311
C17	Area of Impact (Other Vehicle)	AOI2	312
C17	Vehicle Event Number (new added)	VEVENTNUM	312

The VSOE Data Set 313

C17	Vehicle Number	VEH_NO	30713
C17	Area of Impact	AOI	314
V31	Sequence of Events	SOE	309
C17	Vehicle Event Number	VEVENTNUM	313

The FACTOR Data Set 3177

PC4	Contributing Circumstances, Motor Vehicle	MFACTOR	3188
-----	--	---------	------

The VIOLATN Data Set 3199

D21	Violations Charged	MVIOLATN	320
-----	--------------------	----------	-----

The VISION Data Set 32323

PC14	Driver's Vision Obscured by	MVISOBSC	3244
------	-----------------------------	----------	------

The MANEUVER Data Set 3255

PC15	Driver Maneuvered to Avoid	MDRMANAV	3266
------	----------------------------	----------	------

The DISTRACT Data Set 3277

PC16	Driver Distracted By	MDRDSTRD	3288
------	----------------------	----------	------

The DRIMPAIR Data Set 3299

D23	Condition (Impairment) at Time of Crash- Driver	DRIMPAIR	33030
-----	--	----------	-------

The NMIMPAIR Data Set 33131

NM14	Condition (Impairment) at Time of Crash- Non-Motorist	NMIMPAIR	33232
------	--	----------	-------

The NMCRAASH Data Set 33333

NM12	Non-Motorist Action/Circumstances at Time of Crash	MTM_CRSH	3344
------	---	----------	------

The NMPRIOR Data Set 3355

NM11	Non-Motorist Action/Circumstances Prior to Crash	MPR_ACT	3366
------	---	---------	------

The SAFETYEQ Data Set 3377

NM13	Non-Motorist Safety Equipment	MSAFEQMT	3388
------	-------------------------------	----------	------

The PARKWORK Data Set 3399

C4AA	Derived Number of Vehicle Forms Submitted for Motor Vehicle in Transport	PVE_FORMS	34040
V4	Number of Occupants	PNUMOCCS	341
C8A	Month of Crash	PMONTH	342
C8B	Day of Crash	PDAY	34243
C9A	Hour of Crash	PHOUR	344
C9B	Minute of Crash	PMINUTE	345
C18	First Harmful Event	PHARM_EV	346
C19	Manner of Collision	PMAN_COLL	347
V5	Unit Type	PTYPE	3498
V6	Hit and Run	PHIT_RUN	3509
V7	Registration State	PREG_STATE	35150
V8	Registered Vehicle Owner	POWNER	35351
V9	Vehicle Make	PMAKE	3542
V10	Vehicle Model (listed with Vehicle Make)	PMODEL	359
V11	Body Type	PBODYTYP	361
V12	Vehicle Model Year	PMODELYR	366
V13	Vehicle Identification Number (VIN)	PVIN	367
V14	Vehicle Trailing	PTRAILER	368
V16	Motor Carrier Identification Number	PMCARR_ID	369
V16A	MCID Issuing Authority	PMCARR_I1	370
V16B	MCID Identification Number	PMCARR_I2	371
V17	Gross Vehicle Weight Rating/ GCWR	PGVWR	372
V18	Vehicle Configuration	PV_CONFIG	373
V19	Cargo Body Type	PCARGTYP	374
V20A/HM1	Hazardous Material Involvement	PHAZ_INV	376
V20B/HM2	Hazardous Material Placard	PHAZPLAC	376
V20C/HM3	Hazardous Material Identification Number	PHAZ_ID	376
V20D/HM4	Hazardous Material Class Number	PHAZ_CNO	377
V20E/HM5	Release of Hazardous Material from the Cargo Compartment	PHAZ_REL	377
V21	Bus Use	PBUS_USE	378
V22	Special Use	PSP_USE	379
V23	Emergency Use	PEM_USE	380
V25	Underride/Override	PUNDERIDE	381
V28A	Initial Damage Area	PIMPACT1	382
V28B	Most Damaged Area	PIMPACT2	383
V29	Extent of Damage	PVEH_SEV	384

V30	Vehicle Removal	PTOWED	385
V32	Most Harmful Event	PM_HARM	386
V33	Related Factors - Vehicle Level	PVEH_SC1	390
V33	Related Factors - Vehicle Level	PVEH_SC2	390
V34	Fire Occurrence	PFIRE	392
V100	Make Model Combined	PMAK_MOD	393
V113	VIN Vehicle Type	PVINTYPE	394
V114	VIN Make	PVINMAKE	395
V115	VIN Model	PVINA_MOD	396
V116	VIN Body Type	PVIN_BT	397
V117	VIN Model Year	PVINMDYR	401
V118	Curb Weight	PVIN_WGT	402
V119	Wheelbase Short	PWHLBS_SH	403
V120	Wheelbase Long	PWHLBS_LG	404
V121	Fuel Code	PFUECODE	405
V122	VIN Truck Series	PSER_TR	406
V123	Truck Weight Rating	PWGTCR_TR	407
V124	Motorcycle Engine Displacement (CC)	PMCYCL_DS	408
V125	VIN Length	PVIN_LNGT	409
V150	Fatalities in Vehicle (Number)	PDEATHS	410

The PBTYP E Data Set 4111

P5/NM5	Age	PBAGE	412
P6/NM6	Sex	PBSEX	413
P7/NM7	Person Type	PBPTYPE	414
NM9	Marked Crosswalk Present – Pedestrian/Bicyclist	PBCWALK	415
NM9	Side Walk Present – Pedestrian/Bicyclist	PBSWALK	416
NM9	School Zone – Pedestrian/Bicyclist	PBSZONE	417
NM9	Crash Type – Pedestrian	PEDCTYPE	418
NM9	Crash Type – Bicyclist	BIKECTYPE	420
NM9	Crash Location – Pedestrian	PEDLOC	422
NM9	Crash Location – Bicyclist	BIKELOC	423
NM9	Pedestrian Position	PEDPOS	424
NM9	Bicyclist Position	BIKEPOS	425
NM9	Pedestrian Direction	PEDDIR	426
NM9	Bicyclist Direction	BIKEDIR	427
NM9	Motorist Direction	MOTDIR	428
NM9	Motorist Maneuver	MOTMAN	429
NM9	Intersection Leg	PEDLEG	430
NM9	Pedestrian Scenario	PEDSNR	431

NM9	Pedestrian Crash Group	PEDCGP	433
NM9	Bicycle Crash Group	BIKECGP	434

Variable Definitions and Codes

The following variables are contained in all of the data sets:

C1/V1/D1/PC1/P1/NM1 State Number

Definition: This element identifies the state in which the crash occurred. The codes are from the General Services Administration's (GSA) publication of worldwide Geographic Location Codes (GLC).

Additional Information: GSA state elements except for 43, Puerto Rico. The State in which the vehicle is registered, REG_STAT, is found in the Vehicle file; the coding is the same.

SAS Name: STATE

Attribute Codes

1975-Later

01 Alabama	31 Nebraska
02 Alaska	32 Nevada
04 Arizona	33 New Hampshire
05 Arkansas	34 New Jersey
06 California	35 New Mexico
08 Colorado	36 New York
09 Connecticut	37 North Carolina
10 Delaware	38 North Dakota
11 District of Columbia	39 Ohio
12 Florida	40 Oklahoma
13 Georgia	41 Oregon
15 Hawaii	42 Pennsylvania
16 Idaho	43 Puerto Rico
17 Illinois	44 Rhode Island
18 Indiana	45 South Carolina
19 Iowa	46 South Dakota
20 Kansas	47 Tennessee
21 Kentucky	48 Texas
22 Louisiana	49 Utah
23 Maine	50 Vermont
24 Maryland	52 Virgin Islands (<i>since 2004</i>)
25 Massachusetts	51 Virginia
26 Michigan	53 Washington
27 Minnesota	54 West Virginia
28 Mississippi	55 Wisconsin
29 Missouri	56 Wyoming
30 Montana	

C2/V2/D2/PC2/P2/NM2 **Consecutive Number**

Definition: This element is the identifier for the case. This variable is a unique number assigned by the data entry system to each crash. It appears on each data set and is used to merge the information from the data sets together.

Additional Information: This variable is a combination of the GSA State code and an assigned consecutive number. It is a unique identifier for the crash within the year. It is used as the key, when any two of these files from the same year are merged.

This variable is stored as a numeric variable of six characters; the first two characters are the State code, and the next four characters are case number, with leading zeros if necessary.

SAS Name: **ST_CASE**

Attribute Codes**1975-Later**

xxxxxx Two Characters for State Code followed by Four Characters for Case Number

The above variables as well as VEH_NO are found on all vehicle-level data sets:

V3/D3/PC3/P3/NM4 Vehicle Number

Definition: This element identifies the number assigned to each vehicle in the case. This variable appears on each vehicle level data set and is used in conjunction with the ST_CASE variable to merge information from vehicle level data sets.

Additional Information: All vehicles will have a positive integer value. The value 0 is only used for non-motorists (pedestrians, cyclists, etc.) in the Person File. There are no corresponding Vehicle records for non-motorists. ST_CASE and VEH_NO may be used to merge the complete Person File to the Accident File, but including the Vehicle File in the merge will eliminate non-motorists from the merged data.

Non-Occupants have VEH_NO = 00, in this case see N_MOT_NO under Non-Motorist Striking Vehicle Number in the Person File.

SAS Name: **VEH_NO**

Attribute Codes

1975- 2008	2009- Later	
00-99	000-999	Assigned Number of Motor Vehicle

The above variables as well as PER_NO are found on all person-level data sets:

P4/NM3 Person Number

Definition: This element identifies the number assigned to each person in the case. This variable appears on each person level data set and is used in conjunction with the ST_CASE variable (and sometimes the VEH_NO variable) to merge information from person level data sets.

Additional Information: Each occupant of the vehicle is numbered and each non-occupant is numbered, in the case of a non-occupant the vehicle number is zero. The numbers for occupants are consecutive, for each vehicle, beginning with 001. Numbers are never skipped. Drivers do not have to be coded 001. Non-Occupants are identified by vehicle number 0 and are numbered consecutively starting with 01 for each non-motorist. To get drivers see variable PER_TYP, under Person Type.

PER_NO can be used in merges, e.g., when merging the FARS person file with the multiple cause of death file.

SAS Name: PER_NO

Attribute Codes

1975- 2008	2009- Later	
01-99	001-999	Assigned Person Number

The Crash-Level variables above and EVENTNUM are found on the CEVENT, VEVENT and VSOE data sets:

C17 Event Number

Definition: This element identifies the number assigned to each event in the case. The event number(s) show the chronological sequence of the qualifying harmful and non-harmful events in the crash. Qualifying events are those which involve an in-transport motor vehicle or an object set in motion by an in-transport motor vehicle

Additional Information:

SAS Name: **EVENTNUM**

Attribute Codes

2010-Later

001-999 Event Number

The ACCIDENT Data Set

The Accident data set contains the variables ST_CASE and STATE. ST_CASE is the case identifier. The data set also contains:

C3 **Number of Forms Submitted for Persons Not in Motor Vehicles**

Definition: This element records the number of Person Forms (Not a Motor Vehicle Occupant) that are applicable to this case.

Additional Information: Data not available from 1975 to 1990.

SAS Name: **PEDS**

Attribute Codes***1991-Later***

x Number of Non-Motorists

C4 **Number of Vehicle Forms Submitted - ALL**

Definition: This element records the number of contact motor vehicles that the officer reported on the Police Accident Report (PAR) as a unit involved in the crash.

Additional Information: This counts all of the vehicles in the crash. This includes the vehicles in transport which are documented in the Vehicle File and the vehicles not in transport which are documented in the Vehnit File. This variable only appears in the Accident File. The Vehnit File does not exist prior to 2005.

SAS Name: **VE_TOTAL**

Attribute Codes

2005- 2008	2009- Later	
01-99	001-999	Number of Vehicles in Crash

C4AA Derived Number of Vehicle Forms Submitted for Motor Vehicle in Transport

Definition: This element records the number of Vehicle forms submitted. It counts the number of vehicles in transport involved in the crash. Legally parked vehicles are not included.

Additional Information: It is unlikely that the number of vehicles involved in the crash is greater than the Number of Vehicle Forms plus two.

This variable also appears in the Vehicle, Person and Parkwork data sets.

1975-1981: In the event of a hit-and-run crash, if the vehicle information was not known, then no vehicle form was filled out. Likewise, if no information was known on the person level, usually the driver of the unknown vehicle, then a Person Level form was not filled out. The result is that the number of unknowns is much smaller for this time period than 1982 and later.

Example: From 1975 to 1980, there were 30 to 40 drivers coded with unknown sex, approximately 0.05 percent of all drivers involved in fatal crashes. In 1981 the number of drivers with unknown sex rose to over 300, approximately 0.5 percent of all drivers involved in fatal crashes.

1982-Later: In the case of a hit-and-run crash, a Vehicle-Driver form and a Person Level form for the driver are filled out. When the information about the vehicle-driver or person is not known -- which is often the case with hit-and-runs -- the values are coded as unknown.

Example: Between 1982 and 1994, the number of drivers coded with unknown sex fluctuated between 700 and 1,000, approximately 1.5 percent of all drivers involved in fatal crashes. Reviewing the 768 persons in the 1994 Annual Report file, all were drivers and 90 percent of them were involved in hit-and-run crashes.

SAS Name: **VE_FORMS**

Attribute Codes

1976- 1981	1982- 2008	2009- Later	
00-99	01-99	001-999	Number of Vehicle Forms

Vehicles in Transport (discontinued)

Definition: This element counts the number of vehicles in transport involved in the crash. Legally parked vehicles are not included.

Additional Information: This variable was discontinued after 1981.

SAS Name: **VEHICLES**

Attribute Codes

1976-1981
01-99

C5 Number of Motor Vehicle Occupant Forms Submitted

Definition: This element records the number of Person Forms (Motor Vehicle Occupant) that are applicable to this case.

Additional Information: This is the number of persons involved in the crash, except for uninjured bus and train passengers. A form describing all other persons involved in a crash will be filed, i.e., this variable is a count of the persons in the crash.

Before 2003, the policy was not to submit a Person Level form for occupants of van-based buses. Since 2003, a person level form has been submitted for all occupants of van-based vehicles, including van-based buses.

1975-1981: *In the event of a hit-and-run crash, if the vehicle information was not known, then no vehicle form was filled out. Likewise, if no information was known on the person level, usually the driver of the unknown vehicle, then a Person Level form was not filled out. The result is that the number of unknowns is much smaller for this time period than 1982 and later.*

Example: From 1975 to 1980, there were 30 to 40 drivers coded with unknown sex, approximately 0.05 percent of all drivers involved in fatal crashes. In 1981 the number of drivers with unknown sex rose to over 300, approximately 0.5 percent of all drivers involved in fatal crashes.

1982-Later: *In the case of a hit-and-run crash, a Vehicle-Driver form and a Person Level form for the driver are filled out. When the information about the vehicle-driver or person is not known -- which is often the case with hit-and-runs -- the values are coded as unknown.*

Example: Between 1982 and 1994, the number of drivers coded with unknown sex fluctuated between 700 and 1,000, approximately 1.5 percent of all drivers involved in fatal crashes. Reviewing the 768 persons in the 1994 Annual Report file, all were drivers and 90 percent of them were involved in hit-and-run crashes.

SAS Name: PERSONS

Attribute Codes

1975- 2008	2009- Later	
00-99	001-999	Number of Person Forms

C6 County

Definition: This element refers to the location of the unstabilized event.

Additional Information: GSA geographical codes are somewhat stable. Occasionally one code will be divided into two codes.

This variable also appears in the Person data set.

SAS Name: COUNTY

Attribute Codes

<i>1975- 2009</i>	<i>2010- Later</i>	
000	000	Not Applicable
001-996	001-996	Use GSA Geographical Codes
997	997	Other
--	998	Not Reported
999	999	Unknown

C7 City

Definition: This element refers to the location of the unstabilized event.

Additional Information: GSA geographical codes are somewhat stable. Occasionally one code will be divided into two codes.

SAS Name: CITY

Attribute Codes

1975- 2009	2010- Later	
0000	0000	Not Applicable
0001-9996	0001-9996	GSA Geographical Codes
9997	9997	Other
--	9898	Not Reported
9999	9999	Unknown

C8 Crash Date

C8A Month of Crash

Definition: This element identifies the month on which the crash occurred.

Additional Information: This variable also appears in the Vehicle and Person data sets and in the Parkwork data set as PMONTH.

SAS Name: MONTH

Attribute Codes

1975- 2008	2009- Later	
01	01	January
02	02	February
03	03	March
04	04	April
05	05	May
06	06	June
07	07	July
08	08	August
09	09	September
10	10	October
11	11	November
12	12	December
99	--	Unknown

C8B Day of Crash

Definition: This element identifies the day of the month on which the crash occurred.

Additional Information: This variable also appears in the Vehicle and Person data sets and in the Parkwork data set as PDAY.

SAS Name: DAY

Attribute Codes

1975- 2009	2010- Later	
01-31	01-31	Day of the Month of the Crash
99	--	Unknown

C8C Day of Week

Definition: This element identifies the day of the week on which the crash occurred.

Additional Information: This variable has been calculated based on the year, month, and day.

SAS Name: DAY_WEEK

Attribute Codes**1975-Later**

- 1 Sunday
- 2 Monday
- 3 Tuesday
- 4 Wednesday
- 5 Thursday
- 6 Friday
- 7 Saturday
- 9 Unknown

C8D Year of Crash

Definition: This element identifies the year in which the crash occurred.

Additional Information:

SAS Name: YEAR

Attribute Codes

**1975- 1998-
1997 Later**

xx xxxx Year of the Crash

More Information on [Date of Crash](#)

C9 **Crash Time**

C9A **Hour of Crash**

Definition: This element identifies the hour at which the crash occurred.

Additional Information: All time is 24-hour military time.

The time of the crash/arrival of the emergency medical service can occur in a different day than the arrival of emergency medical service at the crash scene/hospital.

If you need to separate day and night, see the variable LGT_COND under the heading Light Condition.

This variable also appears in the Vehicle and Person data sets and in the Parkwork data set as PHOUR.

SAS Name: **HOURL**

1975- 1998	1999- 2008	2009	2010- Later	
00-24	00-24	00-23	00-23	Valid Military Times
--	--	88	--	Not Applicable or Not Notified
99	99	99	99	Unknown

C9B **Minute of Crash**

Definition: This element identifies the minutes after the hour at which the crash occurred.

Additional Information: All time is 24-hour military time.

The time of the crash/arrival of the emergency medical service can occur in a different day than the arrival of emergency medical service at the crash scene/hospital.

This variable also appears in the Vehicle and Person data sets and in the Parkwork data set as PMINUTE.

SAS Name: **MINUTE**

1975- 2008	2009	2010- Later	
00-59	00-59	00-59	Valid Military Times
--	88	--	Not Applicable or Not Notified
99	99	99	Unknown

C10 National Highway System

Definition: This element indicates whether this crash occurred on a trafficway that is part of the National Highway System.

Additional Information:

SAS Name: NHS

Attribute Codes

1994-Later

- 0 This Section is Not on the National Highway System
- 1 This Section is on the National Highway System
- 9 Unknown

Federal Highway (discontinued)

Definition: This variable was discontinued after 1993.

Additional Information: The variable is in the file, but was not initialized prior to 1978, i.e., no data exists for this variable. This may be due to the extensive revisions by the Federal Highway Administration (FHWA) in 1977, which caused extensive modifications to this field for all data before 1978.

SAS Name:

TA_1_CL 1975-1981

FED_AID 1982-1993

Attribute Codes

1975- 1977	1978- 1981	1982- 1986	1987 1993	
--	1	1	1	Interstate
--	2	2	--	Other Federal Aid Primary
--	--	--	2	Federal Aid Primary (<i>Other Than Interstate</i>)
--	3	3	--	Federal Aid Secondary
--	--	--	3	Federal Aid Urban
--	4	4	--	Federal Aid Urban Arterials
--	--	--	4	Federal Aid Secondary (<i>Rural Only</i>)
--	5	5	--	Federal Aid Urban Collectors
--	--	--	5	Non-Federal Aid
--	6	6	--	Non-Federal Aid Arterials
--	7	7	--	Non-Federal Aid Collectors
--	8	8	--	Non-Federal Aid Local
--	9	9	9	Unknown

C11 Roadway Function Class

Definition: This element identifies the functional classification of the trafficway on which the crash occurred.

Additional Information: This variable also appears in the Person data set.

SAS Name: ROAD_FNC

Attribute Codes**1975-1980**

This variable is included in the format, but is not initialized. Do not use it.

1981-1986

- 1 Principal Arterial - Interstate
- 2 Principal Arterial - Other Urban Freeways and Expressways
- 3 Principal Arterial - Other
- 4 Minor Arterial
- 5 Urban Collector
- 6 Major Rural Collector
- 7 Minor Rural Collector
- 8 Local Road or Street
- 9 Unknown

1987-Later

- 00 None
- 01 Rural Principal Arterial - Interstate
- 02 Rural Principal Arterial - Other
- 03 Rural Minor Arterial
- 04 Rural Major Collector
- 05 Rural Minor Collector
- 06 Rural Local Road or Street
- 09 Rural Unknown
- 11 Urban Principal Arterial - Interstate
- 12 Urban Principal Arterial - Other Freeways or Expressways
- 13 Urban Other Principal Arterial
- 14 Urban Minor Arterial
- 15 Urban Collector
- 16 Urban Local Road or Street
- 19 Urban Unknown
- 99 Unknown

Land Use (discontinued)

Definition: This variable was discontinued after 1986.

Additional Information: The variable LAND_USE is defined by the Federal Highway Administration and does not necessarily coincide with the U.S. Census Bureau's definition or any other definition of urban or rural. It has been determined there are errors in the 1975 and 1976 data for this variable; consequently, care should be taken when comparing data over several years.

SAS Name: `LAND_USE`

Attribute Codes

1975-1986

- 1 Urban
- 2 Rural
- 9 Unknown

More Information on [Roadway Function Class and Land Use](#)

C12 Route Signing

Definition: This element identifies the route signing of the trafficway on which the crash occurred.

Additional Information:

SAS Name: **CL_TWAY** 1975-1986
ROUTE 1987-Later

Attribute Codes

1975-1980	1982-1986	
1	1	Interstate
2	--	Other Limited Access
3	2	Other U.S. Route
4	3	Other State Route
5	--	Other Major Artery
6	4	County Road
7	5	Local Street
8	8	Other Road
9	9	Unknown

1981

Data were not available for this variable in 1981.

1987-Later

- 1 Interstate
- 2 U.S. Highway
- 3 State Highway
- 4 County Road
- 5 Local Street - Township
- 6 Local Street - Municipality
- 7 Local Street - Frontage Road (*Since 1994*)
- 8 Other
- 9 Unknown

C13 Trafficway Identifier

Definition: This element captures the identity (name) of the trafficway on which the crash occurred.

Additional Information: Beginning in 2004, a second trafficway identifier was added to accommodate intersection and intersection-related crashes where the officer provides the identifier for the second trafficway.

SAS Name: **TWAY_ID** *1982-Later*
TWAY_ID2 *2004-Later*

Attribute Codes

1982-1997

xxxxxxxx	Actual Posted Number, Assigned Number, or Common Name
99999999	Unknown

1998-Later

xxxxxxxxxxxxxxxxxxxx	Actual Posted Number, Assigned Number, or Common Name
999999999999999999	Unknown

More Information on [Trafficway Identifier](#)

C14 Milepoint

Definition: This element identifies the milepoint nearest to the location where the crash occurred.

Additional Information: Five digits are always coded.

EXAMPLES:

<i>Milepoint</i>	<i>Code</i>
10	00100
39.89	00399
404	04040
73.1	00731

SAS Name: MILEPT

Attribute Codes

1982- 2009	2010- Later	
00000	00000	None
xxxxx	xxxxx	Actual to Nearest Tenth Mile (<i>Assume decimal, e.g., 12345 = 1234.5</i>)
--	99998	Not Reported
99999	99999	Unknown

C15 Global Position

C15A Latitude

Definition: This element identifies the location of the crash using Global Position coordinates. This is the position of latitude.

Additional Information:

SAS Name: **LATITUDE**

Attribute Codes

1999-2009

DDMMSSSS (DD MM SS.SS – Degrees/Minutes/Seconds)

17-71	DD- Actual Degrees
88	Not Available (<i>If State Exempt</i>)
99	Unknown

00-59	MM- Actual Minutes
88	Not Available (<i>If State Exempt</i>)
99	Unknown

00.00-59.99	SS.SS- Actual Seconds
88.88	Not Available (<i>If State Exempt</i>)
99.99	Unknown

2010-Later

DDDDDD (DD.DDDD – Decimal Degrees)

DD.DDDD	Actual Degrees
77.7777	Not Reported
88.8888	Not Available (<i>If State Exempt</i>)
99.9999	Unknown

C15B Longitude

Definition: This element identifies the location of the crash using Global Position coordinates. This is the position of longitude.

Additional Information:

SAS Name: LONGITUD

Attribute Codes

DDMMSSSS (DDD MM SS.SS – Degrees/Minutes/Seconds)

1999-2009

DDMMSSSS (DDD MM SS.SS – Degrees/Minutes/Seconds)

065-178	DDD- Actual Degrees
--	Not Reported
888	Not Available (<i>If State Exempt</i>)
999	Unknown

00-59	MM- Actual Minutes
--	Not Reported
88	Not Available (<i>If State Exempt</i>)
99	Unknown

00.00-59.99	SS.SS- Actual Seconds
--	Not Reported
88.88	Not Available (<i>If State Exempt</i>)
99.99	Unknown

2010-Later

DDDDDDD (DDD.DDDD – Decimal Degrees)

DDD.DDDD	Actual Degrees
777.7777	Not Reported
888.8888	Not Available (<i>If State Exempt</i>)
999.9999	Unknown

C16 Special Jurisdiction

Definition: This element indicates whether the location on the trafficway where the crash occurred qualifies as a Special Jurisdiction even though it may be patrolled by state, county or local police (e.g., all State highways running through Indian reservations are under the jurisdiction of the Indian reservation).

Additional Information:

SAS Name: **SP_JUR**

Attribute Codes**1975-Later**

- 0 No Special Jurisdiction (*Included National Forests Since 2008*)
- 1 National Park Service
- 2 Military
- 3 Indian Reservation
- 4 College/University Campus
- 5 Other Federal Properties (*Since 1977*)
- 8 Other (*Since 1976*)
- 9 Unknown

C18 First Harmful Event

Definition: This element is defined as the first injury or damage producing event of the crash.

Additional Information: First harmful event applies to the crash. The most harmful event variable M_HARM applies to the vehicle. Harmful events are judgment calls of the FARS analysts based on the data within the police crash report.

This variable also appears in the Vehicle and Person data sets and in the Parkwork data set as PHARM_EV.

SAS Name: HARM_EV

Attribute Codes**1975-1981**

01	Overturn
02	Fire/Explosion
03	Immersion
04	Gas Inhalation
05	Fell from Vehicle
06	Injured in Vehicle
07	Other Non-Collision
08	Pedestrian
09	Pedalcycle
10	Railway Train
11	Animal
12	Motor Vehicle in Transport
13	Motor Vehicle in Transport in Other Roadway
14	Parked Motor Vehicle
15	Other Type Non-Motorist
16	Other Object
17	Bridge or Overpass (1975-1978 Only)
18	Building
19	Culvert
20	Curb or Wall
21	Divider
22	Embankment
23	Fence
24	Guard Rail
25	Light Support
26	Sign Post
27	Tree/Shrubbery
28	Utility Pole
29	Other Pole/Support
30	Impact Attenuator
31	Other Fixed Object
32	Bridge or Overpass [Passing Under] (1979-1981 Only)
33	Bridge or Overpass [Passing Over] (1979-1981 Only)
99	Unknown

C18 First Harmful Event (continued)**Attribute Codes**

1982- 2003	2004- 2009	2010- Later	
01	01	01	Rollover/Overturn
02	02	02	Fire/Explosion
03	03	03	Immersion
04	04	04	Gas Inhalation
05	05	05	Fell/Jumped from Vehicle
06	06	--	Injured in Vehicle
--	--	06	Injured in Vehicle (<i>Non-Collision</i>)
07	07	07	Other Non-Collision
08	08	08	Pedestrian
09	09	--	Pedalcycle
--	--	09	Pedalcyclist
10	10	--	Railway Train
--	--	10	Railway Vehicle
11	11	--	Animal
--	--	11	Live Animal
12	12	--	Motor Vehicle in Transport on Same Roadway
--	--	12	Motor Vehicle in Transport
13	13	--	Motor Vehicle in Transport on Other Roadway
14	14	14	Parked Motor Vehicle (<i>Not In Transport</i>)
15	--	--	Other Type Non-Motorist
--	15	15	Non-Motorist on Personal Conveyance
16	16	16	Thrown or Falling Object
17	17	17	Boulder
18	18	18	Other Object (<i>Not Fixed</i>)
19	19	19	Building
20	20	20	Impact Attenuator/Crash Cushion
21	21	--	Bridge Pier or Abutment
--	--	21	Bridge Pier or Support
22	22	--	Bridge Parapet End
23	23	--	Bridge Rail
--	--	23	Bridge Rail (<i>Includes Parapet</i>)
24	24	24	Guardrail Face
25	25	25	Concrete Traffic Barrier
26	26	26	Other Traffic Barrier
27	27	--	Highway/Traffic Sign Post
28	28	--	Overhead Sign Support/Sign
29	29	--	Luminary/Light Support
30	30	--	Utility Pole
--	--	30	Utility Pole/Light Support
31	31	31	Other Post, Other Pole, or Other Support
32	32	32	Culvert
33	33	33	Curb
34	34	34	Ditch

C18 First Harmful Event (continued)**Attribute Codes**

1982- 2003	2004- 2009	2010- Later	
35	35	--	Embankment - Earth
--	--	35	Embankment
36	36	--	Embankment - Rock, Stone, or Concrete
37	37	--	Embankment - Material Type Unknown
38	38	38	Fence
39	39	39	Wall
40	40	40	Fire Hydrant
41	41	41	Shrubbery
42	42	42	Tree (<i>Standing Only</i>)
43	43	43	Other Fixed Object
44	--	--	Pavement Surface Irregularity (<i>1993 Only</i>)
--	44	--	Pavement Surface Irregularity
--	--	44	Pavement Surface Irregularity (<i>Ruts, Potholes, Grates, etc.</i>)
45	--	--	Transport Device Used as Equipment (<i>1993-2003 Only</i>)
45	45	--	Working Construction, Maintenance or Utility Vehicles
--	--	45	Working Motor Vehicle
46	46	46	Traffic Signal Support
47	47	--	Vehicle Occupant Struck or Run Over by Own Vehicle (<i>Since 1997</i>)
48	48	--	Collision With Snow Bank (<i>Since 1997</i>)
--	--	48	Snow Bank
49	49	49	Ridden Animal or Animal-Drawn Conveyance (<i>Since 1998</i>)
50	50	50	Bridge Overhead Structure
--	51	--	Jackknife
--	--	51	Jackknife (<i>Harmful to This Vehicle</i>)
--	52	52	Guardrail End
--	53	53	Mail Box
--	54	--	Motor Vehicle Struck by Falling/Shifting Cargo or Anything Set in Motion by Another Motor Vehicle in Transport
--	--	54	Motor Vehicle In-Transport Strikes or is Struck by Cargo, Persons or Objects Set-in-Motion from/by Another Motor Vehicle In-Transport
--	55	--	Other Not in-Transport Motor Vehicle (<i>2005-2007 Only</i>)
--	55	55	Motor Vehicle in Motion Outside the Trafficway (<i>Since 2008</i>)
--	57	57	Cable Barrier (<i>Since 2008</i>)
--	--	58	Ground
--	--	59	Traffic Sign Support
--	60	--	Cargo/Equipment Loss or Shift
--	61	--	Equipment Failure (<i>Blown Tire, Brake Failure, etc.</i>)
--	62	--	Separation of Units
--	63	--	Ran Off Road - Right
--	64	--	Ran Off Road - Left
--	65	--	Cross Median/Centerline
--	66	--	Downhill Runaway
--	67	--	Vehicle Went Airborne

C18 First Harmful Event *(continued)*

Attribute Codes

1982- 2003	2004- 2009	2010- Later	
--	--	72	Cargo/Equipment Loss or Shift (<i>Harmful to This Vehicle</i>)
--	--	98	Not Reported
99	99	99	Unknown

C19 Manner of Collision

Definition: This element identifies the orientation of two motor vehicles in-transport when they are involved in the First Harmful Event of a collision crash. If the First Harmful Event is not a collision between two motor vehicles in-transport it is classified as such.

Additional Information: In the original files, from 1975 to 1977 sideswipe was coded as 5 but has since been changed to 7. These years are not consistent with the documentation of the time.

This variable also appears in the Vehicle and Person data sets and in the Parkwork data set as PMAN_COLL.

SAS Name: **MAN_COLL**

Attribute Codes

1975- 1977	1978- 2001	
0	0	Not Collision With Motor Vehicle in Transport
1	1	Rear-End
2	2	Head-On
3	3	Rear-to-Rear
4	4	Angle
--	5	Sideswipe, Same Direction
--	6	Sideswipe, Opposite Direction
7	--	Sideswipe (<i>May Either Be Same or Opposite Direction</i>)
9	9	Unknown

Attribute Codes

2002- 2009	2010- Later	
00	00	Not Collision with Motor Vehicle in Transport (<i>Not Necessarily in Transport for 2005-2009</i>)
01	01	Front-to-Rear
02	02	Front-to-Front
03	--	Angle - Front-to-Side, Same Direction
04	--	Angle - Front-to-Side, Opposite Direction
05	--	Angle - Front-to-Side, Right Angle (<i>Includes Broadside</i>)
06	--	Angle - Front-to-Side/Angle-Direction Not Specified
--	06	Angle
07	07	Sideswipe - Same Direction
08	08	Sideswipe - Opposite Direction
09	09	Rear-to-Side
10	10	Rear-to-Rear
11	11	Other (<i>End-Swipes and Others</i>)
--	98	Not Reported
99	99	Unknown

More Information on [Manner of Collision](#)

C20 Relation to Junction

C20A Relation to Junction- Within Interchange Area

Definition: This element identifies the crash's location with respect to presence in an interchange area and the crash's location with respect to presence in or proximity to components typically in junction or interchange areas. The coding of this data element is done in two sub-fields (see also C20B) and based on the location of the first harmful event of the crash.

Additional Information:

SAS Name: RELJCT1

Attribute Codes**2010-Later**

- 0 No
- 1 Yes
- 8 Not Reported
- 9 Unknown

C20B Relation to Junction- Specific Location

Definition: This element identifies the crash's location with respect to presence in an interchange area and the crash's location with respect to presence in or proximity to components typically in junction or interchange areas. The coding of this data element is done in two sub-fields (see also C20A) and based on the location of the first harmful event of the crash.

Additional Information:

SAS Name: REL_JUNC 1975-2009
RELJCT2 2010-Later

Attribute Codes**1975-1990**

- 1 Non-Junction
- 2 Intersection
- 3 Intersection-Related
- 4 Intersection Area
- 5 Driveway, Alley, Access, etc.
- 6 Entrance/Exit Ramp (*Since 1978*)
- 7 Rail Grade Crossing (*Since 1979*)
- 8 In Crossover (*Since 1980*)
- 9 Unknown

C20B Relation to Junction- Specific Location (continued)

Attribute Codes**1991-2009**

00 None

NON-INTERCHANGE

- 01 Non-Junction
- 02 Intersection
- 03 Intersection-Related
- 04 Driveway, Alley Access, etc.
- 05 Entrance/Exit Ramp-Related
- 06 Railway Grade Crossing
- 07 In Crossover
- 08 Driveway Access Related (*Since 2003*)
- 09 Unknown, Non-Interchange

INTERCHANGE AREA

- 10 Intersection
- 11 Intersection-Related
- 12 Driveway Access
- 13 Entrance/Exit Ramp-Related
- 14 In Crossover
- 15 Other Location in Interchange
- 19 Unknown, Interchange Area
- 99 Unknown

2010-Later

- 00 None
- 01 Non-Junction
- 02 Intersection
- 03 Intersection-Related
- 04 Driveway Access
- 05 Entrance/Exit Ramp-Related
- 06 Railway Grade Crossing
- 07 Crossover Related
- 08 Driveway Access Related (*Since 2003*)
- 16 Shared-Use Path or Trail
- 17 Acceleration/Deceleration Lane
- 18 Through Roadway
- 19 Other Location Within Interchange Area
- 98 Not Reported
- 99 Unknown

C21 **Type of Intersection**

Definition: This element identifies and allows separation of various intersection types.

Additional Information:

SAS Name: **TYP_INT**

Attribute Codes***2010-Later***

- 1 Not an Intersection
- 2 Four-Way Intersection
- 3 T-Intersection
- 4 Y-Intersection
- 5 Traffic Circle
- 6 Roundabout
- 7 Five-Point, or More
- 8 Not Reported
- 9 Unknown

C22 Relation to Trafficway

Definition: This element identifies the location of the crash as it relates to its position within or outside the trafficway based on the First Harmful Event.

Additional Information:

SAS Name: REL_ROAD

Attribute Codes**1975-1997**

- 1 On Roadway
- 2 Shoulder
- 3 Median
- 4 Roadside
- 5 Outside Right-of-way
- 6 Off Roadway - Location Unknown
- 7 In Parking Lane (*Since 1980*)
- 8 Gore (*Since 1982*)
- 9 Unknown

1998-2009 **2010-
Later**

- | | | |
|----|----|---|
| 01 | 01 | On Roadway |
| 02 | 02 | On Shoulder |
| 03 | 03 | On Median |
| 04 | 04 | On Roadside |
| 05 | -- | Outside Trafficway/Outside Right-Of-Way |
| -- | 05 | Outside Trafficway |
| 06 | 06 | Off Roadway - Location Unknown |
| 07 | -- | In Parking Lane (<i>1998-2006 Only</i>) |
| 07 | 07 | In Parking Lane/Zone (<i>Since 2007</i>) |
| 08 | 08 | Gore |
| 10 | 10 | Separator |
| 11 | -- | Two-way Continuous Left-Turn Lane (<i>Since 2001</i>) |
| -- | 11 | Continuous Left-Turn Lane |
| -- | 98 | Not Reported |
| 99 | 99 | Unknown |

More Information on [Relation to Trafficway](#)

C23 Work Zone

Definition: This element identifies whether this was a “Work Zone Accident” as defined in ANSI D16.1, 7th Edition. If the crash qualifies as a "Work Zone Accident" then the type of work activity is identified.

Additional Information: Use of the codes does not imply that the crash was caused by the construction, maintenance, or work activity.

The element name was “Construction/Maintenance Zone” from 1975 to 2008. The element name has been changed to “Work Zone” since 2009.

SAS Name: **C_M_ZONE** 1975-1981
WRK_ZONE 2009-Later

Attribute Codes**1975-1979**

The variable exists in the data sets but has not been initialized. The data was not collected.

**1980- 1982- 2010-
 1981 2009 Later**

0	0	0	None
1	1	1	Construction
2	2	2	Maintenance
3	--	--	Construction or Maintenance
--	3	3	Utility
--	4	4	Work Zone, Type Unknown
--	--	8	Not Reported

C24 Light Condition

Definition: This element records the type/level of light that existed at the time of the crash as reported in the case materials.

Additional Information:

SAS Name: **LGT_COND**

Attribute Codes

1975- 1979	1980- 2009	2010- Later	
1	1	1	Daylight
2	2	--	Dark (<i>1975 to 2008</i>)
--	2	2	Dark – Not Lighted (<i>Since 2009</i>)
3	3	--	Dark but Lighted
--	--	3	Dark – Lighted
--	4	4	Dawn
--	5	5	Dusk
6	--	--	Dawn or Dusk
--	6	6	Dark – Unknown Lighting (<i>Since 2009</i>)
--	7	7	Other (<i>Since 2009</i>)
--	--	8	Not Reported
9	9	9	Unknown

C25 Atmospheric Conditions

Definition: This element identifies the prevailing atmospheric conditions that existed at the time of the crash as recorded on the crash report form.

Additional Information:

SAS Name: **WEATHER** 1975-2006
WEATHER, WEATHER1, WEATHER2 2007-Later

Attribute Codes

1975- 1979	1980- 1981	1982- 2006	2007- 2009	2010- Later	
1	--	--	--	01	Clear
--	1	--	--	--	Normal
--	--	1	0	--	No Adverse Atmospheric Conditions
--	--	--	--	00	No Additional Atmospheric Conditions
--	--	--	1	--	Clear/Cloud (<i>No Adverse Conditions</i>)
2	2	--	--	02	Rain
--	--	2	2	--	Rain (<i>Mist</i>)
3	3	--	--	--	Sleet
--	--	3	3	--	Sleet (<i>Hail</i>)
--	--	--	--	03	Sleet, Hail (<i>Freezing Rain or Drizzle</i>)
4	4	4	--	04	Snow
--	--	--	4	--	Snow or Blowing Snow
--	5	5	--	--	Fog
--	--	--	5	05	Fog, Smog, Smoke
--	--	6	--	--	Rain and Fog
--	--	--	6	06	Severe Crosswinds
--	--	7	--	--	Sleet and Fog
--	--	--	7	07	Blowing Sand, Soil, Dirt
--	8	8	--	--	Other: Smog, Smoke, Blowing Sand or Dust
--	--	--	8	08	Other
7	--	--	--	10	Cloudy
--	--	--	--	11	Blowing Snow
--	--	--	--	98	Not Reported
9	9	9	9	99	Unknown

C26 School Bus Related

Definition: This element indicates whether a school bus, or motor vehicle functioning as a school bus, was involved in the crash.

Additional Information: A school bus crash is (1) a motor vehicle crash in which a school bus, with or without a pupil on board, is involved directly as a contact vehicle, or (2) a motor vehicle crash or an other-road-vehicle crash in which a school bus, with or without a pupil or board, is involved indirectly as a non-contact vehicle.

School Bus - refers to a motor vehicle which satisfies the following criteria:

- externally identifiable to other traffic units as a school/pupil transport vehicle;
- operated or owned by a public school or private school;
- where the institution's students may range from pre-school through high school;
- whose occupants, if any, are associated with the institution; and,
- the vehicle is in operations at the time of the crash to and from the school or on a school-sponsored activity or trip.

Also check the variable SPEC_USE in the Vehicle file. When the variable SPEC_USE is set to the value 2 then the vehicle is used as a school bus.

This code applies to crashes in which a vehicle functioning as a school bus was directly or indirectly involved. The "school bus" does not have to be a traffic unit in the crash, but it must have been involved in some school-related activity (e.g., children boarding or alighting from the bus; bus stopping at or pulling from a location of such activity, etc.)

If school-bus-related is yes, then the crash and all fatalities in that crash are school-bus-related.

Additional explanation - inclusions:

- A collision involving a motor vehicle in transport in which one or more than one school bus strikes or is struck by another road vehicle (directly involved).
- A collision involving a pedestrian in which a child approaching or leaving a school bus, stopped and with its red lights flashing, is struck and injured by a motor vehicle (indirectly involved).
- A collision crash or non-collision crash involving a motor vehicle in transport passing a school bus stopped and with its red lights flashing (the school bus is a non-contact vehicle indirectly involved).
- A collision crash in which a child approaching or leaving a school bus, stopped and with its red light flashing, is struck and injured by a pedalcyclist (school bus indirectly involved).

Additional explanation - exclusions:

- A collision crash or non-collision crash involving a motor vehicle which is normally used as a school bus, but is carrying only senior citizens when the collision occurs.

This variable also appears in the Person data set.

C26 School Bus Related (continued)

SAS Name: **SCH_BUS****Attribute Codes**

1977- 2009	2010- Later	
0	0	No
1	1	Yes
--	8	Not Reported

C27 Rail Grade Crossing Identifier

Definition: This element indicates whether the crash occurred in or near a Rail Grade Crossing.

Additional Information:

SAS Name: RAIL

Attribute Codes***1979-Later***

000000	Not Applicable
xxxxxA	Six Digits Followed by One Alphabetic Valid F.R.A. Code
999999	Unknown

C28 Notification Time EMS

C28A Hour of Notification

Definition: This element identifies the hour that emergency medical service was notified.

Additional Information: All time is 24-hour military time.

SAS Name: NOT_HOUR

1975- 1998	1999- 2008	2009- Later	
00-24	00-24	00-23	Valid Military Times
--	--	88	Not Applicable or Not Notified
99	99	99	Unknown

C28B Minute of Notification

Definition: This element identifies the minutes after the hour that emergency medical service was notified.

Additional Information:

SAS Name: NOT_MIN

1975- 2008	2009- Later	
00-59	00-59	Valid Military Times
--	88	Not Applicable or Not Notified
99	99	Unknown

C29 Arrival Time EMS

C29A Hour of Arrival at Scene

Definition: This element identifies the hour that emergency medical service arrived on the crash scene.

Additional Information: All time is 24-hour military time.

The time of the crash/arrival of the emergency medical service can occur in a different day than the arrival of emergency medical service at the crash scene/hospital.

SAS Name: **ARR_HOUR**

1975- 1998	1999- 2008	2009- Later	
00-24	00-24	00-23	Valid Military Times
--	--	88	Not Applicable or Not Notified
99	99	99	Unknown

C29B Minute of Arrival at Scene

Definition: This element identifies the minutes after the hour that emergency medical service arrived on the crash scene.

Additional Information: The time of the crash/arrival of the emergency medical service can occur in a different day than the arrival of emergency medical service at the crash scene/hospital.

SAS Name: **ARR_MIN**

1975- 2008	2009- Later	
00-59	00-59	Valid Military Times
--	88	Not Applicable or Not Notified
99	99	Unknown

C30 EMS Time at Hospital

C30A Hour of EMS Arrival at Hospital

Definition: This element identifies the hour that emergency medical service arrived at the treatment facility to which it was transporting victims of the crash.

Additional Information: All time is 24-hour military time.

The time of the crash/arrival of the emergency medical service can occur in a different day than the arrival of emergency medical service at the crash scene/hospital.

SAS Name: HOSP_HR

1975- 1998	1999- 2008	2009- Later	
00-24	00-24	00-23	Valid Military Times
--	--	88	Not Applicable or Not Notified
99	99	99	Unknown

C30B Minute of EMS Arrival at Hospital

Definition: This element identifies the minutes after the hour that emergency medical service arrived at the treatment facility to which it was transporting victims of the crash.

Additional Information: The time of the crash/arrival of the emergency medical service can occur in a different day than the arrival of emergency medical service at the crash scene/hospital.

SAS Name: HOSP_MIN

1975- 2008	2009- Later	
00-59	00-59	Valid Military Times
--	88	Not Applicable or Not Notified
99	99	Unknown

C31 Related Factors- Crash Level

Definition: This element identifies factors related to the crash expressed by the investigating officer.

Additional Information: There are also vehicle-level-related factors in the Vehicle file, VEH_CF1 and VEH_CF2 (SAS names changed to be VEH_SC1 and VEH_SC2 in 2010) and driver-related factors, also in the Vehicle file, namely DR_CF1, DR_CF2, DR_CF3 and (DR_CF4 since 1997). In addition there are person-related factors P_CF1, P_CF2, and P_CF3 in the person file. SAS names changed to be DR_SF1-DR_SF4 and P_SF1-P_SF3 in 2010.

The FARS analyst may have used any of the three variables to code a related factor. One must test all three variables to insure that the selected related factor is included.

Note: Starting in 1982, many of the Related Factors Crash Level factors, values 01 - 29, are coded as Related Factors - Driver Level, values 61 - 87, in the vehicle section of the data.

SAS Name: CF1, CF2, CF3

Attribute Codes**1975-1981**

00 None

VISION OBSCURED BY:

- 01 Rain, Snow, Fog, Smoke, Sand, Dust (*i.e., Weather Conditions*)
- 02 Reflected Glare, Bright Sunlight, Headlights
- 03 Curve, Hill or Other Design Features (*Including Traffic Signs, Embankments*)
- 04 Building, Billboard, etc.
- 05 Trees, Crops, Vegetation
- 06 Moving Vehicle (*Including Load*)
- 07 Parked Vehicle
- 08 Other Object Not Classified Above

SWERVING DUE TO:

- 20 Severe Crosswind
- 21 Wind From Passing Truck
- 22 Slippery Surface
- 23 Avoiding Debris or Objects in Road
- 24 Ruts, Holes, Bumps, in Road
- 25 Avoiding Animals in Road
- 26 Avoiding Vehicle in Road
- 27 Avoiding Phantom Vehicle
- 28 Avoiding Pedestrian, Pedalcyclist, Other Non-Motorist in Road
- 29 Avoiding Water, Snow, Oil Slick on Road

C31 Related Factors- Crash Level (continued)

Attribute Codes**1975-1981***ROADWAY FEATURES:*

- 40 Traffic Controls Not Functioning Properly
- 41 Inadequate Warning of Exits, Lanes Narrowing, Traffic Controls, etc.
- 42 Uncontrolled Intersection or Railroad Crossing
- 43 Shoulder Too Low or High
- 44 Shoulders Too Narrow or No Shoulders for Emergency Use
- 47 Other Construction
- 48 No or Obscured Pavement Markings
- 49 Surface Underwater (*Since 1979*)
- 50 Inadequate Construction or Poor Design of Roadway, Bridge, etc. (*Since 1979*)
- 51 Surface Washed Out (*Caved in, Road Slippage, Since 1979*)
- 99 Unknown

1982-Later

- 00 None
- 01 Inadequate Warning of Exits, Lanes Narrowing, Traffic Controls etc.
- 02 Shoulder-Related (*Design or Condition Since 2002*)
- 03 Other Construction-Created Condition
- 04 No or Obscured Pavement Marking
- 05 Surface Under Water
- 06 Inadequate Construction or Poor Design of Roadway, Bridge, etc.
- 07 Surface Washed Out (*Caved in, Road Slippage*)
- 13 Aggressive Driving/Road Rage by Non-contact Vehicle Driver (*Since 2006*)
- 14 Motor Vehicle (*In Transport 1983-2004 Only*) struck by falling cargo or something that came loose from or something that was set in motion by a vehicle (*Since 1983*)
- 15 Non-Occupant struck by falling cargo, or something came loose from or something that was set in motion by a vehicle (*Since 1983*)
- 16 Non-Occupant struck vehicle (*Since 1983*)
- 17 Vehicle set in motion by non-driver (*Since 1983*)
- 18 Date of Crash and Date of EMS Notification were not the same day (*Since 1988*)
- 19 Recent previous crash scene nearby (*Since 1989*)
- 20 Police-Pursuit-Involved (*Since 1994*)
- 21 Within Designated School Zone (*Since 1995*)
- 22 Speed Limit Is a Statutory Limit as Recorded or Was Determined as This State's "Basic Rule" (*Since 1999*)
- 23 Indication of a Stalled/Disabled Vehicle (*Since 2008*)
- 99 Unknown

More Information on [Related Factors- Crash Level](#)

C100 Drunk Driver

Definition: This element records the number of drunk drivers involved in the fatal crash.

Additional Information: This is a derived variable. Data from the Vehicle file are analyzed and if there is sufficient information to conclude that a driver was drunk, i.e., if the blood alcohol concentration (BAC) is positive, or if the police reported alcohol involvement, then the driver is counted as a drunk driver. A driver being charged with an alcohol violation by itself does not have the driver counted as a drunk driver. Note that alcohol data is often missing. For that reason this variable may undercount the actual number of drunk drivers. For detailed analysis of alcohol involvement, the alcohol files should be used.

A crash is alcohol-involved if a driver, pedestrian, or pedal cyclist involved in the crash has (1) police-reported alcohol involvement, or (2) a positive alcohol test result.

From 1975 to 1993 the maximum number of drunk drivers was 6. Virtually all crashes have no more than two drunk drivers.

Two useful partitions of this variable are:

- (1) no drunk drivers, one or more drunk drivers involved, and
- (2) no drunk drivers, one drunk driver, multiple drunk drivers

In the early years of FARS, especially 1975 and 1976, the alcohol data must be used with care. In these two years no drunk drivers were identified for North Dakota. In 1975/76 Alabama, Mississippi, New Mexico, North Carolina, Texas, and West Virginia have a reported drunk driver rate for fatal crashes of less than 5 percent. In 1979 the data from these States reports a drunk-driver rate for fatal crashes between 18.5 percent and 43 percent.

Note: The DRUNK_DR element on the Crash level was incorrectly derived on all person types from 1999 through 2007. Since then, it was derived based on all person types rather than based on Drivers only. Furthermore, the variable name (DRUNK_DR) implies that the individual was drunk, however, it actually captures those individuals whom the police reported alcohol involvement OR who tested positive for alcohol (i.e. their blood alcohol concentration was .01 g/dL or greater). Beginning with the 2008 Final FARS file, DRUNK_DR has been derived for Drivers only.

SAS Name: DRUNK_DR

Attribute Codes**1975-Later**

00-99 Number of Drunk Drivers Involved in the Fatal Crash.

C101 Fatalities

Definition: This element records the number of fatally injured individuals in the crash.

Additional Information: This variable is equivalent to looking at the sum from the Person file where INJ_SEV = 4.

SAS Name: **FATALS**

Attribute Codes***1975-Later***

01-99 Number of Fatalities that Occurred in the Crash.

PC5 Trafficway Description

Definition: This element identifies the attribute that best describes the trafficway flow just prior to this vehicle’s critical precrash event, based on the case materials.

Additional Information: In 1975 and 1976 all divided highway traffic is coded as Level Element 3, i.e., divided highway, other barrier or barrier type unknown. There is no distinction made among median strips, guardrails and other barriers for these two years.

In 2010, this variable was no longer collected at the Accident level. It is now collected at the Vehicle level and appears on the Vehicle data set as VTRAFWAY.

SAS Name: **ROAD_FLO** 1975-1981
TWAY_FLO 1982-1986
TRAF_FLO 1987-2009

Attribute Codes

1975-1981

- 1 Divided Highway, Median Strip (*Since 1977*)
- 2 Divided Highway, Guardrail (*Since 1977*)
- 3 Divided Highway, Other Barrier or Barrier Type Unknown
- 4 Not Physically Divided
- 5 One Way Traffic
- 9 Unknown

1982-1986 1987-2002 2003-2009

- 1 1 1 Not Physically Divided (*Two-Way Trafficway*)
- 2 2 2 Divided Highway, Median Strip (*Without Traffic Barrier*)
- 3 3 3 Divided Highway, Median Strip (*With Traffic Barrier*)
- 4 4 4 One-Way Trafficway
- 5 -- Divided Highway, Median Strip (*With Two-Way Continuous Left-Turn Lane, Since 2001*)
- -- 5 Not Physically Divided (*With Two-Way Continuous Left-Turn Lane*)
- -- 6 Entrance/Exit Ramp
- 9 9 9 Unknown

PC6 Total Lanes in Roadway

Definition: This element identifies the attribute that best describes the number of travel lanes just prior to this vehicle's critical precrash event, based on the case materials.

Additional Information: The number of lanes refers to the number of lanes of a continuous cross-section of roadway. For example, a local roadway with one lane going north and one lane going south would be coded as two lanes. However, if a trafficway is a divided highway, with two lanes going north, a median, and two lanes going south, then the number of lanes is coded as two. If a trafficway has two lanes going north immediately adjacent to two lanes going south, one continuous cross-section of roadway, then the number of lanes is coded as four. This variable can be used with the trafficway flow variable TRAF_FLO to determine the trafficway geometry. For example: If (NO_LANES EQ 2) AND (TRAF_FLO EQ 1), then one has a two-lane roadway that is not physically divided, that is what most people think of as a two-lane road, one lane going in each direction.

In 2010, this variable was no longer collected at the Accident level. It is now collected at the Vehicle level and appears on the Vehicle data set as VNUM_LAN.

SAS Name: NO_LANES

Attribute Codes

1975- 1979	1980- 2009	
1	1	One Lane
2	2	Two Lanes
3	3	Three Lanes
4	4	Four Lanes
5	5	Five Lanes
6	6	Six or More Lanes
--	7	Seven or More Lanes
9	9	Unknown

PC7 Posted Speed Limit

Definition: This element identifies the attribute that best represents the posted speed limit just prior to this vehicle's critical precrash event, based on the case materials.

Additional Information: In 2010, this variable was no longer collected at the Accident level. It is now collected at the Vehicle level and appears on the Vehicle data set as VSPD_LIM.

SAS Name: **SP_LIMIT**

Attribute Codes

1975- 1976	1977- 1978	1979	1980- 2009	
--	--	--	00	No Statutory Limit
01-94	01-94	01-98	01-98	Speed Limit in Miles per Hour
95	95	--	--	Speed Limit Is 95 mph or Greater
96	96	--	00	No Statutory Limit
98	--	--	--	Not Reportable
99	99	99	99	Unknown

PC8 Roadway Alignment

Definition: This element identifies the attribute that best represents the roadway alignment prior to this vehicle's critical precrash event, based on the case materials.

Additional Information: In 2010, this variable was no longer collected at the Accident level. It is now collected at the Vehicle level and appears on the Vehicle data set as VALIGN.

SAS Name: **ALIGNMNT**

Attribute Codes**1975-2009**

- 1 Straight
- 2 Curved
- 9 Unknown

PC9 Roadway Grade

Definition: This element identifies the attribute that best represents the roadway grade prior to this vehicle's critical precrash event, based on the case materials.

Additional Information: In 2010, this variable was no longer collected at the Accident level. It is now collected at the Vehicle level and appears on the Vehicle data set as VPROFILE.

SAS Name: **PROFILE**

Attribute Codes**1975-1981**

- 1 Level
- 2 Grade
- 9 Unknown

1982-2009

- 1 Level
- 2 Grade
- 3 Hillcrest
- 4 Sag
- 9 Unknown

PC10 Roadway Surface Type

Definition: This element identifies the attribute that best represents the roadway surface type prior to this vehicle's critical precrash event, based on the case materials.

Additional Information: In 2010, this variable was no longer collected at the Accident level. It is now collected at the Vehicle level and appears on the Vehicle data set as VPAVETYP.

SAS Name: **PAVE_TYP**

Attribute Codes**1975-2009**

- 1 Concrete
- 2 Blacktop, Bituminous, or Asphalt
- 3 Brick or Block
- 4 Slag, Gravel or Stone
- 5 Dirt
- 8 Other
- 9 Unknown

PC11 Roadway Surface Condition

Definition: This element identifies the attribute that best represents the roadway surface condition prior to this vehicle's critical precrash event, based on the case materials.

Additional Information: In 2010, this variable was no longer collected at the Accident level. It is now collected at the Vehicle level and appears on the Vehicle data set as VSURCOND.

SAS Name: **SUR_COND**

Attribute Codes

1975- 2006	2007- 2009	
1	1	Dry
2	2	Wet
3	3	Snow or Slush
4	--	Ice
--	4	Ice/Frost
5	--	Sand, Dirt, Oil
--	5	Sand, Dirt, Mud, Gravel
--	6	Water (<i>Standing or Moving</i>)
--	7	Oil
8	8	Other
9	9	Unknown

PC12 Traffic Control Device

Definition: This element identifies the attribute that best describes the traffic controls in the vehicle's environment just prior to this vehicle's critical precrash event, based on the case materials.

Additional Information: In 2010, this variable was no longer collected at the Accident level. It is now collected at the Vehicle level and appears on the Vehicle data set as VTRAFCON.

SAS Name: **TRA_CONT**

Attribute Codes**1975-1981**

- 00 No Controls
- 01 Flashing Traffic Signals
- 02 On Colors Traffic Signal
- 03 Stop Sign
- 04 Yield Sign
- 05 Physically Controlled Railroad Crossing
- 06 Stop Sign for Railroad Crossing
- 07 Other Railroad Crossing
- 08 School Zone Sign
- 09 Traffic Controls Not Functioning
- 10 Pedestrian Signal (*Since 1978*)
- 98 Other
- 99 Unknown

1982-2009

- 00 No Controls

NOT AT RAILROAD GRADE CROSSINGS*HIGHWAY TRAFFIC SIGNALS*

- 01 Traffic Control Signal (*On Colors*) Without Pedestrian Signal
- 02 Traffic Control (*On Colors*) With Pedestrian Signal
- 03 Traffic Control Signal (*On Colors*) Not Known if Pedestrian Signal
- 04 Flashing Traffic Control Signal
- 05 Flashing Beacon
- 06 Flashing Highway Traffic Signal, Type Unknown, or Other
- 07 Lane Use Control Signal
- 08 Other Highway Traffic Signal
- 09 Unknown Highway Traffic Signal

PC12 Traffic Control Device (continued)

Attribute Codes**1982-2009***REGULATORY SIGNS*

- 20 Stop Sign
- 21 Yield Sign
- 28 Other Regulatory Sign
- 29 Unknown Type Regulatory Sign

SCHOOL ZONE SIGNS

- 30 School Speed Limit Sign
- 31 School Advance or Crossing Sign
- 38 Other School-Related Sign
- 39 Unknown Type School Zone Sign

WARNING SIGN

- 40 Warning Sign
- 41 Electronic Warning Sign (*Since 2002*)

MISCELLANEOUS NOT AT RAILROAD CROSSING

- 50 Officer, Crossing Guard, Flagman, etc.

AT RAILROAD GRADE CROSSINGS*ACTIVE DEVICES*

- 60 Gates
- 61 Flashing Lights
- 62 Traffic Control Signal
- 63 Wigwags
- 64 Bells
- 68 Other Train-Activated Device
- 69 Active Device, Type Unknown

PASSIVE DEVICES

- 70 Cross Bucks
- 71 Stop Sign
- 72 Other Railroad Crossing Sign
- 73 Special Warning Device Watchman, Flagged By Crew
- 78 Other Passive Device
- 79 Passive Device, Type Unknown

MISCELLANEOUS DEVICES AT RAILROAD CROSSING

- 80 Grade Crossing Controlled, Type Unknown

WHETHER OR NOT AT RAILROAD GRADE CROSSING

- 98 Other
- 99 Unknown

PC13 Traffic Control Device Functioning

Definition: This element identifies the functionality of the traffic control device recorded for this vehicle in the element Traffic Control Device.

Additional Information: Data not collected prior to 1982.

In 2010, this variable was no longer collected at the Accident level. It is now collected at the Vehicle level and appears on the Vehicle data set as VTCONT_F.

SAS Name: T_CONT_F

Attribute Codes**1982-2009**

- 0 No Controls
- 1 Device Not Functioning
- 2 Device Functioning - Functioning Improperly
- 3 Device Functioning Properly
- 9 Unknown

The VEHICLE Data Set

The Vehicle data set includes Vehicle as well as Driver and Precrash data. It contains the variables ST_CASE, STATE, and VEH_NO. ST_CASE and VEH_NO are the case identifiers. The data set also contains:

V4 **Number of Occupants**

Definition: This element records the number of occupants in each vehicle.

Additional Information: All, some, or none of the individuals may have died in the crash.

SAS Name: **OCUPANTS** *1975-2008*
 NUMOCCS *2009-Later*

Attribute Codes

<i>1975- 2008</i>	<i>2009</i>	<i>2010- Later</i>	
00	00	00	None
01-95	01-95	01-95	The Actual Number of Occupants in The Vehicle
96	96	96	96 Or More Occupants in The Vehicle
97	--	--	Unknown - Only Injured Reported
--	--	98	Not Reported
99	99	99	Unknown

V5 Unit Type

Definition: This element identifies the type of unit that applies to this motor vehicle at the time it became an involved vehicle in the crash and was reported as a unit on the Police Accident Report (PAR).

Additional Information:

SAS Name: **UNITTYPE**

Attribute Codes

2005- 2007	2008- Later	
1	--	Motor Vehicle in Transport
--	1	Motor Vehicle in Transport (<i>Inside or Outside the Trafficway</i>)
2	2	Motor Vehicle Not in Transport Within the Trafficway
3	3	Motor Vehicle Not in Transport Outside the Trafficway
4	4	Working Motor Vehicle (<i>Highway Construction, Maintenance, Utility Only</i>)

V6 Hit and Run

Definition: This element indicates whether the vehicle was a contact vehicle in the crash that did not stop to render aid (this can include drivers who flee the scene on foot).

Additional Information: This element has been removed from Accident file since 2009.

From 1975 to 1981 if no information was known about the Hit-and-Run vehicle and/or driver, the vehicle form and/or driver form were not filled out and were not counted as unknown. Starting in 1982 both a vehicle and a driver form were filled out and the data were identified as unknown. This is why, for example, there were approximately only 20 to 40 drivers with unknown sex listed in the FARS data set from 1975 to 1981 and 700 to 1,000 drivers with unknown sex from 1982 on.

This variable also appears in the Parkwork data set as PHIT_RUN.

SAS Name: HIT_RUN

Attribute Codes

1975- 1976	1977- 1981	1982- 2008	2009	2010- Later	
0	--	--	--	--	Not Applicable
--	0	0	0	0	No / No Hit-and-Run
1	1	--	--	--	With Motor Vehicle
--	--	1	--	--	Hit Motor Vehicle in Transport
--	--	--	1	1	Yes
2	--	--	--	--	With Non-Occupant
--	2	--	--	--	Hit Non-Motorist
--	--	2	--	--	Hit Pedestrian or Non-Motorist
--	3	--	--	--	Left Scene
--	--	3	--	--	Hit Parked Vehicle (<i>Working Vehicle, Since 2004</i>) or Object
--	--	4	--	--	Occupant Is Struck by or Fell From Own Hit-and-Run Vehicle (<i>2002 Only</i>)
--	--	4	--	--	Driver Leaves Scene after Non-Collision Event (<i>Since 2004</i>)
--	--	5	--	--	Driver/Occupant Leaves Scene after a Non-Collision Event (<i>2003 Only</i>)
--	--	5	--	--	Other Involved Person, not a driver, left Scene (<i>2005-2006</i>)
--	--	5	--	--	Hit-and-Run, Other Involved Person Left Scene (<i>Since 2007</i>)
--	--	--	--	8	Not Reported
--	--	--	9	9	Unknown

V7 Registration State

Definition: This element identifies the state in which this vehicle was registered.

Additional Information: For multiple state registrations prior to 1997 the value is 94. In 1997, values 93 and 94 were combined into 93. After 1997, the value for multiple state registrations is 93.

SAS Name: **REG_STATE**

Attribute Codes**1975-Later**

01 Alabama	30 Montana
02 Alaska	31 Nebraska
03 American Samoa	32 Nevada
04 Arizona	33 New Hampshire
05 Arkansas	34 New Jersey
06 California	35 New Mexico
08 Colorado	36 New York
09 Connecticut	37 North Carolina
10 Delaware	38 North Dakota
11 District of Columbia	39 Ohio
12 Florida	40 Oklahoma
13 Georgia	41 Oregon
14 Guam	42 Pennsylvania
15 Hawaii	43 Puerto Rico
16 Idaho	44 Rhode Island
17 Illinois	45 South Carolina
18 Indiana	46 South Dakota
19 Iowa	47 Tennessee
20 Kansas	48 Texas
21 Kentucky	49 Utah
22 Louisiana	50 Vermont
23 Maine	51 Virginia
24 Maryland	52 Virgin Islands (<i>Since 2004</i>)
25 Massachusetts	53 Washington
26 Michigan	54 West Virginia
27 Minnesota	55 Wisconsin
28 Mississippi	56 Wyoming
29 Missouri	

V7 Registration State (continued)**Attribute Codes**

1975- 2007	2008- 2009	2010- Later	
--	--	00	Not Applicable
--	--	91	Not Reported
92	92	92	No Registration
93	93	93	Multiple State Registrations
94	--	--	Multiple State Registrations - Out-of-State
--	94	94	U.S. Government Tags (<i>Includes Military</i>)
95	--	--	U.S. Government Tags
--	95	95	Canada
96	--	--	Military Vehicle
--	96	96	Mexico
97	--	--	Foreign Country
--	97	97	Other Foreign Country
98	--	--	Other Registration
--	98	98	Other Registration (<i>Includes Native American Indian Nations</i>)
99	99	99	Unknown

V8 Registered Vehicle Owner

Definition: This element indicates the type of registered owner of the vehicle.

Additional Information: This variable also appears in the Parkwork data set.

SAS Name: OWNER

Attribute Codes

1991- 2007	2008- Later	
0	0	Not Applicable, Vehicle Not Registered
1	1	Driver (<i>of This Vehicle</i>) Was Registered Owner
2	2	Driver (<i>of This Vehicle</i>) Not Registered Owner (<i>Other Private Owner</i>)
3	3	Vehicle Registered as Business/Company/Government Vehicle
4	4	Vehicle Registered as Rental Vehicle
5	5	Vehicle Was Stolen (<i>Reported By Police</i>)
6	--	Driverless Vehicle
--	6	Driverless/Motor Vehicle Parked/Stopped Off Roadway
9	9	Unknown

V9 Vehicle Make

Definition: This element identifies the make (manufacturer) of this vehicle.

Additional Information: For 1986 and earlier data, one may have to refer to the first several values, 01-09, with a single digit rather than a double digit with a leading "0" zero, e.g., 6 for Chrysler rather than 06 for Chrysler. This may be system-dependent.

This variable also appears in the Person data set.

SAS Name: MAKE

Attribute Codes**1975-1990**

01	American Motors
02	Jeep
03	AM General
06	Chrysler
07	Dodge
08	Imperial
09	Plymouth
10	Eagle (<i>Not Before 1988</i>)
12	Ford
13	Lincoln
14	Mercury
18	Buick
19	Cadillac
20	Chevrolet
21	Oldsmobile
22	Pontiac
23	GMC
29	Other Domestic
30	Volkswagen
31	Alfa Romeo
32	Audi
33	Austin-Healey
35	Datsun
36	Fiat
37	Honda
38	Isuzu
39	Jaguar
40	Lancia
41	Mazda
42	Mercedes-Benz
43	MG
44	Peugeot
45	Porsche
46	Renault
47	Saab
48	Subaru

V9 Vehicle Make (continued)

Attribute Codes**1975-1990**

- 49 Toyota
- 50 Triumph
- 51 Volvo
- 52 Mitsubishi (*Not Before 1982*)
- 53 Suzuki (*Not Before 1987*)
- 57 Lexus (*Not Before 1988*)
- 58 Infiniti (*Not Before 1988*)
- 59 Other Imports
- 60 BSA
- 61 Ducati
- 62 Harley-Davidson
- 63 Kawasaki
- 64 Moto Guzzi
- 65 Norton
- 67 Yamaha
- 69 Other Motor Cycle
- 70 Moped
- 80 Brockway
- 81 Diamond Reo
- 82 Freightliner
- 83 FWD
- 84 International Harvester
- 85 Kenworth
- 86 Mack
- 87 Peterbilt
- 88 White
- 95 Other Truck/Bus
- 98 Other Make
- 99 Unknown Make

1991-Later

- 01 American Motors
- 02 Jeep/Kaiser-Jeep/Willys Jeep
- 03 AM General
- 06 Chrysler
- 07 Dodge
- 08 Imperial
- 09 Plymouth
- 10 Eagle
- 12 Ford
- 13 Lincoln
- 14 Mercury
- 18 Buick/Opel
- 19 Cadillac

V9 Vehicle Make (continued)

Attribute Codes**1991-Later**

20	Chevrolet
21	Oldsmobile
22	Pontiac
23	GMC
24	Saturn
25	Grumman
29	Other Domestic
	<i>Avanti</i>
	<i>Checker</i>
	<i>DeSoto</i>
	<i>Excalibur</i>
	<i>Hudson</i>
	<i>Packard</i>
	<i>Panoz</i>
	<i>Saleen</i>
	<i>Studebaker</i>
	<i>Stutz</i>
30	Volkswagen
31	Alfa Romeo
32	Audi
33	Austin/Austin Healey
34	BMW
35	Datsun/Nissan
36	Fiat
37	Honda
38	Isuzu
39	Jaguar
40	Lancia
41	Mazda
42	Mercedes-Benz
43	MG
44	Peugeot
45	Porsche
46	Renault
47	Saab
48	Subaru
49	Toyota
50	Triumph
51	Volvo
52	Mitsubishi
53	Suzuki
54	Acura
55	Hyundai
56	Merkur

V9 Vehicle Make (continued)

Attribute Codes**1991-Later**

57	Yugo
58	Infiniti
59	Lexus
60	Daihatsu
61	Sterling
62	Land Rover
63	KIA
64	Daewoo
65	Smart (<i>Since 2010</i>)
69	Other Imports
	<i>Aston Martin</i>
	<i>Bentley</i>
	<i>Bertone</i>
	<i>Bricklin</i>
	<i>Citroen</i>
	<i>DeLorean</i>
	<i>Desta</i>
	<i>Ferrari</i>
	<i>Gazelle</i>
	<i>Hillman</i>
	<i>Jensen</i>
	<i>Lada</i>
	<i>Lamborghini</i>
	<i>Lotus</i>
	<i>Maserati</i>
	<i>Maybach</i>
	<i>Mini Copper</i>
	<i>Morgan</i>
	<i>Morris</i>
	<i>Reliant (British)</i>
	<i>Rolls-Royce</i>
	<i>Simca</i>
	<i>Singer</i>
	<i>Spyker</i>
	<i>Sunbeam</i>
	<i>TVR</i>
70	BSA
71	Ducati
72	Harley-Davidson
73	Kawasaki
74	Moto Guzzi
75	Norton
76	Yamaha
77	Victory

V9 Vehicle Make (continued)

Attribute Codes**1991-Later**

- 78 Other Make Moped (*Since 2010*)
- 79 Other Make Motored Cycle (*Since 2010*)
- 80 Brockway
- 81 Diamond Reo/Reo
- 82 Freightliner
- 83 FWD
- 84 International Harvester/Navistar
- 85 Kenworth
- 86 Mack
- 87 Peterbilt
- 88 Iveco/Magirus
- 89 White/Autocar, White/GMC
- 90 Bluebird
- 91 Eagle Coach
- 92 Gillig
- 93 MCI
- 94 Thomas Built
- 97 Not Reported (*Since 2010*)
- 98 Other Make
 - Auto-Union-DKW*
 - Carpenter*
 - Collins Bus*
 - DINA*
 - Divco*
 - Hino*
 - Mid Bus*
 - Neoplan*
 - Orion*
 - Oshkosh*
 - Scania*
 - Sterling*
 - UD*
 - Van Hool*
 - Western Star*
- 99 Unknown Make

V10 **Vehicle Model** (*listed with Vehicle Make*)

Definition: This element identifies the model of this vehicle within a given make.

Additional Information: This variable also appears in the Person data set.

SAS Name: MODEL

Attribute Codes

See Appendix A: Vehicle Make/Model Designation

V11 Body Type

Definition: This element identifies a classification of this vehicle based on its general body configuration, size, shape, doors, etc.

Additional Information: This variable also appears in the Person data set.

1975-1981: Within the yearly NHTSA report *Fatal Accident Reporting System*, the term "Light Trucks" includes Vans.

The body type data do not track with the original documentation. For example, the documentation states that BODY_TYP EQ 7 is for utility vehicles. However, when the files are examined one sees that BODY_TYP EQ 43 is the value that will provide the desired result. The files have been modified to make the early years for this variable compatible with 1981.

Note: Utility vehicles are also part of the light truck category

Note: BODY_TYP 40, large limousines, are not included as part of Passenger Cars or Passenger Vehicles.

1982-1990: Within the yearly NHTSA report *Fatal Accident Report System*, the term "Light Truck" includes Vans. Utility vehicles are also part of the light-truck category.

Note: BODY_TYP 13, large limousines and BODY_TYP 14, three-wheel automobiles or automobile derivatives, are not included as part of Passenger Cars or Passenger Vehicles.

Note: A single-unit truck that tows another vehicle, or a bobtail by itself, is considered a combination truck.

1991-Later: Within the yearly NHTSA publication *Traffic Safety Facts*, the term "Light Trucks" includes Vans.

Note: BODY_TYP 12, large limousines and BODY_TYP 13, three-wheel automobiles or automobile derivatives, are not included as part of Passenger Cars or Passenger Vehicles.

When defining School Buses 1993 and later be sure to include the new body type 24 (van-based school bus). However, body type 24 is not part of Buses.

When defining Transit Buses 1993 and later be sure to include the new body type 25 (van-based transit bus). However, body type 25 is not part of Buses.

Note: A single-unit truck that tows another vehicle, or a bobtail, is considered a combination truck.

V11 Body Type (continued)

SAS Name: BODY_TYP**Attribute Codes****1975-1981**

01	Convertible
02	2-Door Sedan HT/Coupe
03	4-Door Sedan HT
04	Hatchback
05	Car-Pickup Body
06	Station Wagon
07	On/Off Road Vehicle – Jeep CJ-S, Bronco, Blazer, Scout, etc. (1975-1979)
08	Other Auto
09	Unknown Auto Type
15	Motorcycle
16	Moped
17	Other Cycle
18	Unknown Cycle
25	School Bus
26	Cross-County
27	Transit Bus
28	Other Bus
29	Unknown Bus
35	Snowmobile
36	Farm Equipment
37	Dune/Swamp Buggy
38	Construction Equipment
39	Ambulance/Hearse Type
40	Large Limousine
41	Camper/Motorhome
42	Fire Truck
43	On/Off-Road Vehicle – Jeep CJ-S, Bronco, Blazer, Scout, etc. (1980-1981)
44	Other Special Vehicle
45	Ambulance EMS
50	Pickup
51	Van
52	Truck-Based Station Wagon
53	Straight Truck, Low GVW
54	Straight Truck, Medium GVW
55	Straight Truck, High GVW
56	Straight Truck, Unknown GVW
57	Two-Unit Truck
58	Multi-Unit Truck
59	Truck-Tractor
60	Unknown Type Truck
99	Unknown

V11 Body Type (continued)

Attribute Codes**1982-1990**

01	Convertible
02	2-Door Sedan/Ht/Coupe
03	3-Door/2-Door Hatchback
04	4-Door Sedan/Ht
05	5-Door/4-Door Hatchback
06	Station Wagon
07	Hatchback/Number of Doors Unknown
08	Other Auto
09	Unknown Auto Type
10	Auto Pickup
11	Auto Panel
12	Short Utility/Not Truck-Based
13	Large Limousine
14	3-Wheel Vehicle Unknown Body Type
20	Motorcycle
21	Moped
27	3-Wheel Motorcycle Or Moped
28	Other Cycle
29	Unknown Cycle
30	School Bus
31	Cross-Country/Intercity
32	Transit Bus
38	Other Bus
39	Unknown Bus
40	Van
41	Van Commercial Cutaway
42	Van Motorhome
48	Other Van Type
49	Unknown Van Type
50	Pickup
51	Pickup W/Slide-In Camper
52	Pickup-Based Motorhome
53	Cab Chassis Based
54	Truck-Based Panel
55	Truck-Based Sw
56	Truck-Based Utility
58	Other Light Conventional Truck
59	Unknown Light Convent Truck
67	Utility, Base Body Unknown
69	Unknown Light Truck

V11 Body Type (continued)**Attribute Codes****1982-1990**

70	Straight Truck, Low GVW
71	Straight Truck, Medium GVW
72	Straight Truck, High GVW
73	Medium/Heavy Truck Motorhome
74	Truck/Tractor
75	Unknown Medium Truck
76	Unknown Heavy Truck
77	Camper/Motorhome
78	Single Unit Straight Truck GVW Unknown
79	Unknown Truck Type
80	Snowmobile
81	Farm Equipment/Not Trucks
82	ATV, Dune/Swamp Buggy
83	Construction Equipment/Not Trucks
88	Other
89	Unknown Other Vehicle
90	3-Wheel Vehicle Unknown Body Type
99	Unknown Body Type

**1991-2009 2010-
2009 Later**

01	01	Convertible (<i>Excludes Sunroof, T-Bar</i>)
02	02	2-Door Sedan/Hardtop/Coupe
03	03	3-Door/2-Door Hatchback
04	04	4-Door Sedan/Hardtop
05	05	5-Door/4-Door Hatchback
06	06	Station Wagon (<i>Excluding Van and Truck-Based</i>)
07	07	Hatchback, Number of Doors Unknown
08	--	Other Auto (<i>1991-1993 only</i>)
08	08	Sedan/Hardtop, Number of Doors Unknown (<i>Since 1994</i>)
09	--	Unknown Auto Type (<i>1991-1993 Only</i>)
09	09	Other or Unknown Automobile Type (<i>Since 1994</i>)
10	10	Auto-Based Pickup
11	11	Auto-Based Panel (<i>Cargo Station Wagon, Auto-Based Ambulance or Hearse</i>)
12	12	Large Limousine - More Than Four Side Doors or Stretch Chassis
13	13	Three-Wheel Automobile or Automobile Derivative
14	14	Compact Utility (<i>ANSI D-16 Utility Vehicle Categories "Small" and "Midsize"</i>)
15	15	Large Utility (<i>ANSI D-16 Utility Vehicle Categories "Full Size" and "Large"</i>)
16	16	Utility Station Wagon
--	17	3-Door Coupe
19	19	Utility Unknown Body

V11 Body Type *(continued)*

Attribute Codes

1991- 2009	2010- Later	
20	20	Minivan
21	21	Large Van – Includes Van-Based Buses
22	22	Step Van or Walk-In Van
23	--	Van Motorhome <i>(Deleted in 2003 and Later)</i>
24	--	Van-Based School Bus <i>(1993-2002 Only)</i>
25	--	Van-Based Transit Bus <i>(1993-2002 Only)</i>
28	28	Other Van Type <i>(Hi-Cube Van)</i>
29	29	Unknown Van Type
30	30	Compact Pickup <i>(Gross Vehicle Weight, GVWR, < 4,500 lbs)</i>
31	31	Standard Pickup <i>(4,500 lbs < GVWR < 10,000 lbs)</i>
32	32	Pickup with Slide-In Camper
33	33	Convertible Pickup
39	39	Unknown <i>(Pickup Style)</i> Light Conventional Truck Type
40	40	Cab Chassis-Based <i>(Includes Light Stake, Light Dump, Light Tow, Rescue Vehicles)</i>
41	41	Truck-Based Panel
42	42	Light-Truck-Based Motorhome <i>(Chassis Mounted)</i>
45	45	Other Light Conventional Truck Type <i>(Includes Stretched Suburban Limousine)</i>
48	48	Unknown Light-Truck Type <i>(Not a Pickup)</i>
49	49	Unknown Light-Vehicle Type <i>(Automobile, Utility Vehicle, Van or Light Truck)</i>
50	50	School Bus
51	51	Cross-Country/Intercity Bus <i>(i.e., Greyhound)</i>
52	52	Transit Bus <i>(City Bus)</i>
58	58	Other Bus Type
59	59	Unknown Bus Type
60	60	Step Van
61	61	Single-Unit Straight Truck <i>(10,000 lbs < GVWR < or = 19,500 lbs)</i>
62	62	Single-Unit Straight Truck <i>(19,500 lbs < GVWR < or = 26,000 lbs)</i>
63	63	Single-Unit Straight Truck <i>(GVWR > 26,000 lbs)</i>
64	64	Single-Unit Straight Truck <i>(GVWR unknown)</i>
65	65	Medium/Heavy Truck-Based Motorhome
66	66	Truck/Tractor (Cab Only, or with Any Number of Trailing Units: Any Weight)
67	67	Medium/Heavy Pickup <i>(GVWR > 10,000 lbs, Since 2001)</i>
71	71	Unknown if Single-Unit or Combination-Unit Medium Truck <i>(10,000 lbs < GVWR < 26,000 lbs)</i>
72	72	Unknown if Single-Unit or Combination-Unit Heavy Truck <i>(GVWR > 26,000 lbs.)</i>
73	73	Camper or Motorhome, Unknown Truck Type
78	78	Unknown Medium/Heavy Truck Type
79	79	Unknown Truck Type

V11 Body Type (continued)

Attribute Codes

1991- 2009	2010- Later	
80	80	Motorcycle
81	81	Moped (<i>Motorized Bicycle</i>)
82	82	Three-Wheel Motorcycle/Moped- Not All-Terrain Vehicle
83	83	Off-Road Motorcycle (<i>2-Wheel, Since 1993</i>)
88	--	Other Motored Cycle Type (<i>Mini-Bikes, Motor Scooters, 1991-2007</i>)
88	88	Other Motored Cycle Type (<i>Mini-Bikes, Motor Scooters, Pocket Motorcycles, Pocket Bikes, Since 2008</i>)
89	89	Unknown Motored Cycle Type
90	90	ATV (<i>All-Terrain Vehicle; Includes 3 or 4 Wheels</i>)
91	91	Snowmobile
92	92	Farm Equipment Other Than Trucks
93	93	Construction Equipment Other Than Trucks (<i>Includes Graders</i>)
94	94	Motorized Wheel Chair (<i>Since 1997</i>)
97	97	Other Vehicle Type (<i>Includes Go-Cart, Fork-Lift, City Street Sweeper, Dune/Swamp Buggy, Golf Cart</i>)
--	98	Not Reported
99	99	Unknown Body Type

More Information on [Vehicle \(Body Type\) Classification](#)

V12 Vehicle Model Year

Definition: This element identifies the manufacturer's model year of this vehicle.

Additional Information: Prior to 1988, a vehicle manufactured as a 1985 model is coded as 85.

This variable also appears in the Person data set.

SAS Name: MOD_YEAR

Attribute Codes

1975- 1997	1998- 2009	2010- Later	
00-98	0000-2010	0000-9997	Actual year of vehicle manufacture
--	--	9998	Not Reported
99	9999	9999	Unknown

V13 Vehicle Identification Number (VIN)

Definition: This element records the vehicle identification number (VIN) of this vehicle.

Additional Information: The first [12 (1994 and later)] [10 (1975-1993)] characters of the vehicle identification number (VIN). The vehicle manufacturers use the VIN to describe certain characteristics of a vehicle and to assign a serial number to the vehicle.

VINA is a software program, maintained by R. L. Polk & Co. that deciphers the VIN for 1966 and newer vehicles that are within the scope of the program. In FARS, the VINA program uses analyst-coded vehicle make, model year and the VIN as input values and returns decoded values for automobiles, trucks, and motorcycles. Vehicle type, determined by the analyst-coded body type, is also used as input to facilitate the program processing. Many variables decoded from the VIN have "VIN" as the first part of their names. Some of the results from the VINA program are used as edit checks for these data.

Starting in 1981, the Vehicle Identification Numbers were required to conform to an international standard. Some of the highlights of those standards appear in the following pages. For vehicles built prior to 1981 one may consult the National Automobile Theft Bureau's publication Passenger Vehicle Identification Manual for the year in question. The VINA program developed by R. L. Polk & Co. is capable of decoding the VIN for model years 1961 and later.

SAS Name: **VIN**

Attribute Codes

1975- 1993	1994- 2008	
xxxxxxxxxx	xxxxxxxxxxxx	First Characters of the VIN

2010- Later	
000000000000	No VIN Required
xxxxxxxxxxxxxx	Actual VIN
888888888888	Not Reported
999999999999	Unknown

More Information on [Vehicle Identification Number \(VIN\)](#)

V14 Vehicle Trailing

Definition: This element indicates whether this vehicle had any attached trailing units or was towing another motor vehicle.

Additional Information: Note that the number of unknowns is 0 until 1982. From 1982 to 1984 the number of unknowns is approximately 2,500 per year. Starting in 1985 the number of unknowns falls to about 300 per year.

This variable not only applies to tractor trailers, but also to boats, cars, and U-Haul-type vehicles that are towed with a trailer hitch. Vehicles pulled by a rope or chain are not counted as towed vehicles.

This variable also appears in the Person data set.

SAS Name: TOW_VEH

Attribute Codes

<i>1975-1981</i>	<i>1982</i>	<i>1983-2003</i>	<i>2004-2008</i>	<i>2009-Later</i>	
0	0	0	0	0	No Trailing Unit
1	--	--	--	--	Yes
--	1	1	1	1	Yes, One Trailing Unit
--	--	2	2	2	Yes, Two Trailing Units
--	--	3	3	3	Yes, Three or More Trailing Units
--	4	4	4	4	Yes, Number of Trailing Units Unknown
--	5	--	--	--	Yes, Two or More Trailing Units
--	--	--	5	--	Vehicle Towing another Motor Vehicle
--	--	--	--	5	Vehicle Towing another Motor Vehicle – Fixed Linkage
--	--	--	--	6	Vehicle Towing another Motor Vehicle – Non-Fixed Linkage
--	--	9	9	9	Unknown

V15 Jackknife

Definition: This element indicates whether this vehicle experienced a "jackknife" anytime during the unstabilized situation.

Additional Information: Jackknife applies to a condition which occurs to a "semi" truck (i.e., cab and one or more trailers) while in motion. The condition reflects a loss of control of the truck by the driver in which the trailer yaws more than 15 degrees from its normal straight line path behind the cab. If the final resting configuration of the vehicle is in the jackknife position, it does not necessarily mean that the vehicle has jackknifed (such as, a crash occurring while the vehicle is backing up or parking).

From 1975 to 1979, the variable exists in the data sets but has not been initialized. These data were not collected. From 1980 to 1981, there is a note in old documentation that suggests that the field for 1980 and perhaps 1981 may be a dummy field, but these data seem reasonable and useable.

SAS Name: **J_KNIFE**

Attribute Codes

1980- 1981	1982- Later	
0	0	Not an Articulated Vehicle
1	1	No
2	--	Yes
--	2	Yes, First Event
--	3	Yes, Subsequent Event

V16 Motor Carrier Identification Number

Definition: This element records the issuing authority and motor carrier identification number if applicable to this vehicle.

Additional Information: This is a derivate variable. It is the combination of two variables MCARR_I1 and MCARR_I2. This variable is only applicable for the following vehicles:

- Medium/Heavy Trucks: vehicles with two axles/six tires and/or gross weight greater than 10,000 pounds.
- Buses with 16 or more seats (including the driver)
- Trucks and Vans of any size carrying hazardous cargo.
- Light commercial trucks pulling a trailer with gross combination weight rating (GCWR) greater than 10,000 pounds.

This variable also appears in the Parkwork data set as PMCARR_ID.

SAS Name: MCARR_ID

Attribute Codes**1998-Later**

xxxxxxxxxx 11-digit combination of MCARR_I1 followed by MCARR_I2

V16A MCID Issuing Authority

Definition: This element records the issuing authority if applicable to this vehicle.

Additional Information: This variable is only applicable for the following vehicles:

- Medium/Heavy Trucks: vehicles with two axles/six tires and/or gross weight greater than 10,000 pounds.
- Buses with 16 or more seats (including the driver)
- Trucks and Vans of any size carrying hazardous cargo.
- Light commercial trucks pulling a trailer with gross combination weight rating (GCWR) greater than 10,000 pounds.

This variable also appears in the Parkwork data set as PMCARR_I1.

SAS Name: **MCARR_I1**

Attribute Codes

1998- 2006	2007- 2009	2010- Later	
00	00	00	Not Applicable
01-56	01-56	01-56	FARS State Code
57	57	57	US DOT
58	--	--	ICC
--	58	58	MC/MX (<i>ICC</i>)
--	--	77	Not Reported
88	88	88	None
95	95	95	Canada
96	96	96	Mexico
99	99	99	Unknown

V16B MCID Identification Number

Definition: This element records the motor carrier identification number if applicable to this vehicle.

Additional Information: This variable is only applicable for the following vehicles:

- Medium/Heavy Trucks: vehicles with two axles/six tires and/or gross weight greater than 10,000 pounds.
- Buses with 16 or more seats (including the driver)
- Trucks and Vans of any size carrying hazardous cargo.
- Light commercial trucks pulling a trailer with gross combination weight rating (GCWR) greater than 10,000 pounds.

This variable also appears in the Parkwork data set as PMCARR_I2.

SAS Name: **MCARR_I2**

Attribute Codes**1998-Later**

xxxxxxxx	Actual 9-Digit Number
00000000	Not Applicable
77777777	Not Reported
88888888	None
99999999	Unknown

V17 Gross Vehicle Weight Rating/GCWR

Definition: This element identifies the gross vehicle weight rating of this vehicle when applicable.

Additional Information: The Gross Vehicle Weight Rating (GVWR) or Gross Combination Weight Rating (GCWR) is a value specified by the manufacturer for a single-unit truck, truck tractor, or trailer. In the absence of a gross vehicle weight rating, an estimate of the gross weight of a fully loaded unit can be substituted.

In 2000 the GVWR was the sum of the weight of the power unit and its trailers. Since 2001 this element is the gross vehicle weight of the Power Unit only. The weight of trailers is not added.

This variable also appears in the Parkwork data set as PGVWR.

SAS Name: **GVWR**

Attribute Codes

2000- 2009	2010- Later	
0	0	Not Applicable
1	1	10,000 lbs or Less
2	2	10,001 lbs - 26,000 lbs
3	3	26,001 lbs or More
--	8	Not Reported
9	9	Unknown

V18 Vehicle Configuration

Definition: This element identifies the general configuration of this vehicle when applicable.

Additional Information: This variable also appears in the Parkwork data set as PV_CONFIG.

SAS Name: **V_CONFIG**

Attribute Codes

1991-1994	1995-2000	2001-2009	2010-Later	
0	0	--	--	Not Applicable, Not a Medium/Heavy Truck or Bus
--	--	00	--	Not Applicable, Not a Medium/Heavy Truck or Bus or Vehicle Displaying a Hazardous Material Placard
--	--	--	00	Not Applicable
1	1	01	--	Single-Unit Truck (2 axles, 6 tires)
--	--	--	01	Single-Unit Truck (2 axles and GVWR more than 10,000 lbs.)
2	2	02	02	Single-Unit Truck (3 or More axles)
--	3	03	--	Single-Unit Truck (Unknown Number of Axles, Tires)
3	4	04	--	Truck/Trailer(s)
--	--	--	04	Truck Pulling Trailer(s)
4	5	05	05	Truck Tractor (Bobtail, i.e., Tractor Only, No Trailer)
5	6	--	--	Truck Tractor/Semi-Trailer
--	--	06	--	Tractor/Semi-Trailer (One Trailer)
--	--	--	06	Tractor/Semi-Trailer
--	--	07	--	Tractor/Doubles (Two Trailers)
--	--	--	07	Truck Tractor/Double
--	--	08	--	Tractor/Triples (Three Trailers)
--	--	--	08	Truck Tractor/Triple
--	--	--	10	Vehicle 10,000 lbs or Less Placarded for Hazardous Materials
6	7	19	--	Medium/Heavy Trucks, Cannot Classify
--	--	--	19	Truck More than 10,000 lbs., Cannot Classify
7	8	--	--	Bus
--	--	20	--	Bus (Seats for 9-15 Occupants, Including Driver)
--	--	--	20	Bus/Large Van (Seats for 9-15 Occupants, Including Driver)
--	--	21	--	Bus (Seats for More Than 15 People, Including Driver, 2001-2006)
--	--	21	--	Bus (Seats for 16 or More People, Including Driver, Since 2007-2009)
--	--	--	21	Bus (Seats for More Than 15 Occupants, Including Driver, 2010 and Later)
--	--	70	--	Light Truck (Van, Mini-Van, Panel, Pickup, Sport Utility Vehicle Displaying a Hazardous Material Placard)
--	--	80	--	Passenger Car (Only When Displaying a Hazardous Material Placard)
--	--	--	98	Not Reported
9	--	--	99	Unknown
--	9	99	--	Unknown if Light or Medium/Heavy Truck/Bus

V19 Cargo Body Type

Definition: This element identifies the primary cargo carrying capability of this vehicle when applicable.

Additional Information:

SAS Name: CARGO_BT

Attribute Codes

1991- 1994	1995- 2000	2001- 2008	2009	2010- Later	
00	00	--	--	--	Not Applicable Not a Truck or Bus
--	--	00	--	--	Not Applicable, Not a Medium/Heavy Truck or Bus
--	--	--	00	00	Not Applicable
01	01	01	01	01	Van/Enclosed Box
02	02	02	02	02	Cargo Tank
03	03	03	03	03	Flatbed
04	04	04	04	04	Dump
05	05	05	05	05	Concrete Mixer
06	06	06	06	06	Auto Transporter
07	07	07	07	07	Garbage/Refuse
08	--	--	--	--	Medium/Heavy Truck, Other Body Type
09	08	--	--	--	Bus
--	--	08	08	08	Grain, Chips, Gravel
--	--	09	--	--	Pole
--	--	--	09	09	Pole-Trailer
--	--	10	10	10	Log (<i>Since 2007</i>)
--	--	11	--	--	Intermodal Chassis (<i>2007-2008 Only</i>)
--	--	--	11	11	Intermodal Container Chassis
--	--	12	12	12	Vehicle Towing Another Motor Vehicle (<i>Since 2007</i>)
--	--	20	--	--	Bus (<i>Seats 9-15 People, Including Driver</i>)
--	--	21	--	--	Bus (<i>Seats More than 15 People, Including Driver, 2001-2006 Only</i>)
--	--	21	--	--	Bus (<i>Seats for 16 or More People, Including Driver, 2007-2008 Only</i>)
--	--	--	22	22	Bus
--	--	--	--	28	Not Reported
--	--	96	96	96	No Cargo Body Type
--	97	--	--	--	Medium/Heavy Truck, Other Cargo Body Type
--	--	97	--	--	Medium/Heavy Truck, or Bus, Other Cargo Body Type (<i>Not Elements 01-12, 20-21</i>)
--	--	--	97	97	Other
--	98	--	--	--	Medium/Heavy Truck, Unknown Cargo Body Type
--	--	98	--	--	Medium/Heavy Truck, or Bus, Unknown Cargo Body Type
--	--	--	98	98	Unknown Cargo Body Type

V19 Cargo Body Type (continued)

Attribute Codes

1991- 1994	1995- 2000	2001- 2008	2009	2010- Later	
99	--	--	--	--	Unknown Vehicle Type
--	99	99	--	--	Unknown if Light or Medium/Heavy Truck/Bus (1995-2008)
--	--	--	99	99	Unknown

V20A/HM1 Hazardous Material Involvement

Definition: This element indicates whether the vehicle was carrying hazardous materials.

Additional Information:

SAS Name: HAZ_INV

2007-Later

- 1 No
- 2 Yes

V20B/HM2 Hazardous Material Placard

Definition: This element indicates the presence of hazardous materials and whether the vehicle displayed a hazardous materials placard.

Additional Information:

SAS Name: HAZ_PLAC

2007-Later

- 0 Not Applicable
- 1 No
- 2 Yes
- 8 Not Reported

V20C/HM3 Hazardous Material Identification Number

Definition: This element indicates the 4-digit hazardous material identification number.

Additional Information:

SAS Name: HAZ_ID

2007-Later

- 0000 Not Applicable
- xxxx Actual 4-Digit Number
- 8888 Not Reported

V20D/HM4 Hazardous Material Class Number

Definition: This element indicates the single-digit hazardous material class number for the vehicle.

Additional Information:

SAS Name: HAZ_CNO

2007

0	Not Applicable
1-7 or 9	Actual Number
8	Not Reported

2008-Later

00	Not Applicable
01-09	Actual Number (<i>With Leading Zero</i>)
88	Not Reported

V20E/HM5 Release of Hazardous Material from the Cargo Compartment

Definition: This element indicates whether or not any hazardous cargo was released from the cargo tank or compartment.

Additional Information:

SAS Name: HAZ_REL

2007-Later

0	Not Applicable
1	No
2	Yes
8	Not Reported

Hazardous Material Involvement/Placard (discontinued)

Definition: This element identifies the presence of hazardous cargo for this vehicle and records information about the hazardous cargo when present.

Additional Information: The variable HAZ_CARG is no longer in FARS. It has been replaced with the following five variables HAZ_INV, HAZ_PLAC, HAZ_ID, HAZ_CNO, and HAZ_REL.

SAS Name: **HAZ_CARG**

Attribute Codes

1982- 1990	1991- 2006	
0	0	No
1	--	Yes
--	1	Yes, Placarded
--	2	Yes, Not Placarded
--	3	Yes, Unknown if Placarded
9	9	Unknown

V21 Bus Use

Definition: This element describes the common type of bus service this vehicle was being used as at the time of the crash.

Additional Information: This variable also appears in the Parkwork data set as PBUS_USE.

SAS Name: **BUS_USE**

Attribute Codes**2000-2009**

- 0 Not Used as a Bus
- 1 Used as a Public School Bus
- 2 Used as a Private School Bus
- 3 Used as a School Bus, Public or Private Unknown
- 4 Used as a Scheduled Service Bus
- 5 Used as a Tour Bus
- 6 Used as a Commuter Bus
- 7 Used as a Shuttle Bus
- 8 Modified for Personal/Private Use
- 9 Unknown Bus Use

2010-Later

- 00 Not a Bus
- 01 School Bus
- 04 Intercity Bus
- 05 Charter/Tour Bus
- 06 Transit/Commuter Bus
- 07 Shuttle Bus
- 08 Modified for Personal/Private Use
- 98 Not Reported
- 99 Unknown

V22 Special Use

Definition: This element indicates whether, and in what way, the vehicle was being used for a function other than the primary function for that type vehicle at the time of the crash.

Additional Information: This variable also appears in the Person data set.

SAS Name: **SPEC_USE**

Attribute Codes

1975- 2009	2010- Later	
0	00	No Special Use
1	01	Taxi
2	02	Vehicle Used as School Bus
3	03	Vehicle Used as Other Bus
4	04	Military
5	05	Police
6	06	Ambulance (<i>Since 1980</i>)
7	07	Fire Truck (<i>Since 1982</i>)
8	08	Emergency Services Vehicle (<i>Since 2009</i>)
--	98	Not Reported
9	99	Unknown

V23 Emergency Use

Definition: This element indicates operation of any motor vehicle that is legally authorized by a government authority to respond to emergencies with or without the use of emergency warning equipment, such as a police vehicle, fire truck or ambulance while actually engaged in such response.

Additional Information: This element is applicable only if the vehicle was being used as an emergency vehicle at the time of the crash.

This variable also appears in the Person data set.

SAS Name: EMER_USE

Attribute Codes

<i>1977- 2009</i>	<i>2010- Later</i>	
0	0	No
1	1	Yes
--	8	Not Reported
--	9	Unknown

V24 Travel Speed

Definition: This element records the speed the vehicle was traveling prior to the occurrence of the crash as reported by the investigating officer.

Additional Information: This data is collected after the crash, and is an estimate of the travel speed, which is often a judgment, rather than a measurement. Computing the mean without removing the unknowns will increase the mean travel speed.

For the years 1980 and 1981 travel speed was not collected. However, the variable is currently in the database for these two years with all data as missing. With this variable there have always been a high number of unknown cases. Since the data were considered somewhat "uncollectible," a decision was made not to collect the data for these two years. However, although the data were often unavailable, it was considered too important not to try to collect it.

Since 2005, data have been collected for parked vehicles and vehicles not in transport. The values 00 and 000 only apply to motor vehicles in transport, for example, a vehicle that is in transport, but stopped at a stop light.

SAS Name: TRAV_SP

Attribute Codes

1975- 2008	2010- Later	
00	000	Stopped Motor Vehicle in Transport
01-96	001-151	Travel Speed in mph
97	--	Speed Greater than 96 mph
--	997	Speed Greater than 151 mph
98	998	Not Reported
99	999	Unknown

V25 Underride/Override

Definition: This element indicates this vehicle's involvement in an underride or override during the crash.

Additional Information: Note the striking vehicle, not the vehicle struck, determines the underride/override condition. From 1975 to 1993 both the initial and principal impacts were counted. In the event and only in the event, that the initial or principal impact point was an underride/override were the variable IMPACT1 or IMPACT2 flagged/counted as such. However, all other underrides/overrides were not counted, nor should they have been counted. Impacts were counted, not underrides. Therefore, the variable UNDERIDE was added to the FARS system in 1994.

The variable UNDERIDE, like all FARS variables, is dependent on the data contained in police crash reports. The NASS/CDS system is based on the efforts of professional crash investigators performing detailed analysis of approximately 5,000 crashes a year. An analysis of the 1994-1996 FARS and NASS/CDS data systems and the 1997 Trucks in Fatal Accident file revealed that underrides and overrides are generally not identified on the police crash reports.

This variable also appears in the Parkwork data set.

SAS Name: **UNDERIDE**

Attribute Codes**1994-Later**

- 0 No Underride or Override
- WITH MOTOR VEHICLE IN TRANSPORT*
- 1 Underride (*Compartment Intrusion*)
- 2 Underride (*No Compartment Intrusion*)
- 3 Underride (*Compartment Intrusion Unknown*)
- WITH MOTOR VEHICLE NOT IN TRANSPORT*
- 4 Underride (*Compartment Intrusion*)
- 5 Underride (*No Compartment Intrusion*)
- 6 Underride (*Compartment Intrusion Unknown*)

- 7 Override, Motor Vehicle in Transport
- 8 Override, Motor Vehicle Not in Transport
- 9 Unknown if Underride or Override

V26 Rollover

Definition: This element indicates this vehicle's involvement in a rollover or overturn during the crash.

Additional Information: Data were not available from 1975 to 1977.

This variable also appears in the Person data set.

SAS Name: **ROLLOVER**

Attribute Codes

<i>1978- 2008</i>	<i>2009- Later</i>	
0	0	No Rollover
1	--	First Event
--	1	Rollover, Tripped by Object/Vehicle
2	--	Subsequent Event
--	2	Rollover, Untripped
--	9	Rollover, Unknown Type

V27 Location of Rollover

Definition: This element identifies the location of the trip point or start of the vehicle's roll.

Additional Information:

SAS Name: ROLINLOC

Attribute Codes***2009-Later***

- 0 No Rollover
- 1 On Roadway
- 2 On Shoulder
- 3 On Median/Separator
- 4 In Gore
- 5 On Roadside
- 6 Outside of Trafficway
- 9 Unknown

V28 Area of Impact- Initial/Most Damaged**V28A Initial Damage Area**

Definition: This element identifies the area on this vehicle that produced the first instance of injury to non-motorists or occupants of this vehicle, or that resulted from the first instance of damage to other property or to this vehicle.

Additional Information: The striking vehicle, not the vehicle struck, determines the underide/override condition. After the crash, in the case of an override or underide one vehicle is over the other. If the striking vehicle is over the other, then the crash is an override. If the striking vehicle is under the other, the crash is an underide. See Vehicle Role SAS Name: IMPACTS.

See the note on the page about using and interpreting the variable UNDERIDE

This variable also appears in the Person data set.

SAS Name: **IMPACT1**

Attribute Codes

1975- 1993	1994- 2009	2010- Later	
00	00	00	Non-Collision
01-12	01-12	01-12	Clock points
13	13	13	Top
14	14	14	Undercarriage
15	--	--	Underide (1980-1993 only)
16	--	--	Override (1982-1993 only)
--	18	--	This Vehicle Set Something in Motion Causing Injury or Damage (Not a Clock Point, since 2004)
--	--	18	Set-in-Motion (Not a Clock Point)
--	--	61	Left
--	--	62	Left-Front Half
--	--	63	Left-Back Half
--	--	81	Right
--	--	82	Right-Front Half
--	--	83	Right-Back Half
--	--	98	Not Reported
99	99	99	Unknown

V28 Area of Impact- Initial/Most Damaged (continued)**V28B Most Damaged Area**

Definition: This element identifies the area on this vehicle that was most damaged during an event it underwent in the crash.

Additional Information: The striking vehicle, not the vehicle struck, determines the under/override condition. After the crash, in the case of an override or under/override one vehicle is over the other. If the striking vehicle is over the other, then the crash is an override. If the striking vehicle is under the other, the crash is an under/override. See Vehicle Role SAS Name: IMPACTS.

See the note on the page about using and interpreting the variable UNDERIDE

This variable also appears in the Person data set.

SAS Name: **IMPACT2**

Attribute Codes

1975- 1993	1994- 2009	2010- Later	
00	00	00	Non-Collision
01-12	01-12	01-12	Clock points
13	13	13	Top
14	14	14	Undercarriage
15	--	--	Under/override (1980-1993 Only)
16	--	--	Override (1982-1993 Only)
--	18	--	This Vehicle Set Something in Motion Causing Injury or Damage (Not a Clock Point, Since 2004)
--	--	18	Set-in-Motion (Not a Clock Point)
--	--	61	Left
--	--	62	Left-Front Half
--	--	63	Left-Back Half
--	--	81	Right
--	--	82	Right-Front Half
--	--	83	Right-Back Half
--	--	98	Not Reported
99	99	99	Unknown

More Information on [Impact](#)

V29 Extent of Damage

Definition: This element indicates the amount of damage sustained by this vehicle in this crash as indicated in the case materials based on an operational damage scale.

Additional Information: The element name was “Extent of Deformation” from 1975 to 2008. The element name has been changed to “Extent of Damage” since 2009.

The data on “8 Not Reportable” collected in 1976 are no longer contained in the file. The data for that year are not consistent with the documentation of the time.

SAS Name: **DEFORMED**

Attribute Codes

1975-2008

0	None
2	Other (<i>Minor</i>)
4	Functional (<i>Moderate</i>)
6	Disabling (<i>Severe</i>)
9	Unknown

2009 **2010- Later**

0	0	No Damage
2	2	Minor Damage
4	4	Functional Damage
6	6	Disabling Damage
--	8	Not Reported
9	9	Unknown

V30 Vehicle Removal

Definition: This element describes the mode by which the vehicle left the scene of the crash.

Additional Information: The element name was “Manner of Leaving Scene” from 1975 to 2008. The element name has been changed to “Vehicle Removal” since 2009.

The early years are not consistent with the documentation of the time.

SAS Name: **TOWAWAY** 1975-2008
TOWED 2009-Later

Attribute Codes

	1976- 2008	2009	2010- Later	
--	1	1	1	Driven Away
2	2	--	--	Towed Away
--	--	2	2	Towed Due to Disabling Damage
--	3	--	--	Abandoned/Left Scene
--	--	3	3	Towed Not Due to Disabling Damage
4	--	--	--	Not Towed Away
--	--	4	4	Abandoned/Left Scene
--	--	--	8	Not Reported
9	9	--	--	Unknown
--	--	9	9	Unknown if Towed

V31 Sequence of Events

Definition: The events in sequence related to this motor vehicle, regardless of injury and/or property damage. Events for the vehicle are recorded in the order in which they occur, time-wise, from the Police Accident Report (PAR) narrative and diagram.

Additional Information: Starting in 2004 the HARM_EV, M_HARM and the sequence of event variables, (SEQ_i, 1 ≤ i ≤ 6) have the same values. The harmful event values were modified to be consistent with the sequence of event variables.

SAS Name: SEQ1, SEQ2, SEQ3, SEQ4, SEQ5, SEQ6

Attribute Codes**2004-2009**

- 01 Rollover/Overturn
- 02 Fire/Explosion
- 03 Immersion
- 04 Gas Inhalation
- 05 Fell/Jumped from Vehicle
- 06 Injured in Vehicle
- 07 Other Non-Collision
- 08 Pedestrian
- 09 Pedalcycle
- 10 Railway Train
- 11 Animal
- 12 Motor Vehicle in Transport on Same Roadway
- 13 Motor Vehicle in Transport on Other Roadway
- 14 Parked Motor Vehicle
- 15 Non-Motorist on Personal Conveyance
- 16 Thrown or Falling Object
- 17 Boulder
- 18 Other Object (Not Fixed)
- 19 Building
- 20 Impact Attenuator/Crash Cushion
- 21 Bridge Pier or Abutment
- 22 Bridge Parapet End
- 23 Bridge Rail
- 24 Guardrail Face
- 25 Concrete Traffic Barrier
- 26 Other Traffic Barrier
- 27 Highway/Traffic Sign Post
- 28 Overhead Sign Support/Sign
- 29 Luminary/Light Support
- 30 Utility Pole
- 31 Other Post, Other Pole, or Other Support
- 32 Culvert
- 33 Curb
- 34 Ditch

V31 Sequence of Events (continued)

Attribute Codes**2004-2009**

- 35 Embankment - Earth
- 36 Embankment - Rock, Stone, or Concrete
- 37 Embankment - Material Type Unknown
- 38 Fence
- 39 Wall
- 40 Fire Hydrant
- 41 Shrubbery
- 42 Tree (*Standing Only*)
- 43 Other Fixed Object
- 44 Pavement Surface Irregularity
- 45 Working Construction, Maintenance or Utility Vehicles
- 46 Traffic Signal Support
- 47 Vehicle Occupant Struck or Run Over by Own Vehicle (*Since 1997*)
- 48 Collision With Snow Bank (*Since 1997*)
- 49 Ridden Animal or Animal-Drawn Conveyance (*Since 1998*)
- 50 Bridge Overhead Structure
- 51 Jackknife
- 52 Guardrail End
- 53 Mail Box
- 54 Motor Vehicle Struck by Falling/Shifting Cargo or Anything Set in Motion by Another Motor Vehicle in Transport
- 55 Other Not in-Transport Motor Vehicle (*2005-2007 Only*)
- 55 Motor Vehicle in Motion Outside the Trafficway (*Since 2008*)
- 57 Cable Barrier (*Since 2008*)
- 60 Cargo/Equipment Loss or Shift
- 61 Equipment Failure (*Blown Tire, Brake Failure, etc.*)
- 62 Separation of Units
- 63 Ran Off Road - Right
- 64 Ran Off Road - Left
- 65 Cross Median/Centerline
- 66 Downhill Runaway
- 67 Vehicle Went Airborne
- 99 Unknown

V32 Most Harmful Event

Definition: This element identifies the event that resulted in the most severe injury or, if no injury, the greatest property damage involving this motor vehicle.

Additional Information: First harmful event applies to the crash. The most harmful event variable M_HARM applies to the vehicle. Harmful events are judgment calls of the FARS analysts based on the data within the police crash report.

Most harmful event applies to the vehicle. This variable has the same values as does HARM_EV but is at the vehicle level rather than the crash level. Therefore different vehicles in a crash will have the same first harmful event but may have different most harmful events. Note in particular, that M_HARM describes a vehicle, not a person. Therefore, one cannot assume that the most harmful event for a vehicle was the cause of any death or injury for any specific individual within the vehicle.

Starting in 2004 the HARM_EV, M_HARM and the sequence of event variables, (SEQ_i, 1 ≤ i ≤ 6) have the same values. The harmful event values were modified to be consistent with the sequence of event variables.

If either first harmful event, HARM_EV, or most harmful event, M_HARM, is used, it is often a good idea to construct a two-way table of harmful events by State and check for consistency. For example, in the 1989 FARS data in the cases where a vehicle fire was identified, that is FIRE_EXP = 1, Virginia coded M_HARM as 02 Fire/Explosion for all cases. In the same year for the crashes where a vehicle fire was identified, that is FIRE_EXP = 1, Connecticut, Delaware, Idaho, Kansas, Mississippi, New Hampshire, Oklahoma, Rhode Island, South Dakota, and Wyoming never coded M_HARM as 02 Fire/Explosion. That is, different states code harmful events differently.

This variable also appears in the Parkwork data set as PM_HARM.

SAS Name: **M_HARM**

Attribute Codes**1979-1981**

- 01 Overturn
- 02 Fire/Explosion
- 03 Immersion
- 04 Gas Inhalation
- 05 Fell from Vehicle
- 06 Injured in Vehicle
- 07 Other Non-Collision
- 08 Pedestrian
- 09 Pedalcycle
- 10 Railway Train
- 11 Animal
- 12 Motor Vehicle in Transport
- 13 Motor Vehicle in Transport in Other Roadway
- 14 Parked Motor Vehicle

V32 Most Harmful Event (continued)**Attribute Codes****1979-1981**

15	Other Type Non-Motorist
16	Other Object
17	Bridge or Overpass (1975-1978 only)
18	Building
19	Culvert
20	Curb or Wall
21	Divider
22	Embankment
23	Fence
24	Guard Rail
25	Light Support
26	Sign Post
27	Tree/Shrubbery
28	Utility Pole
29	Other Pole/Support
30	Impact Attenuator
31	Other Fixed Object
32	Bridge or Overpass [Passing Under] (1979-1981 only)
33	Bridge or Overpass [Passing Over] (1979-1981 only)
99	Unknown

1982- 2003	2004- 2009	2010- Later
-----------------------	-----------------------	------------------------

01	01	01	Rollover/Overturn
02	02	02	Fire/Explosion
03	03	03	Immersion
04	04	04	Gas Inhalation
05	05	05	Fell/Jumped from Vehicle
06	06	--	Injured in Vehicle
--	--	06	Injured in Vehicle (Non-Collision)
07	07	07	Other Non-Collision
08	08	08	Pedestrian
09	09	--	Pedalcycle
--	--	09	Pedalcyclist
10	10	--	Railway Train
--	--	10	Railway Vehicle
11	11	--	Animal
--	--	11	Live Animal
12	12	--	Motor Vehicle in Transport on Same Roadway
--	--	12	Motor Vehicle in Transport
13	13	--	Motor Vehicle in Transport on Other Roadway
14	14	14	Parked Motor Vehicle

V32 Most Harmful Event (continued)

Attribute Codes

1982- 2003	2004- 2009	2010- Later	
15	--	--	Other Type Non-Motorist
--	15	15	Non-Motorist on Personal Conveyance
16	16	16	Thrown or Falling Object
17	17	17	Boulder
18	18	18	Other Object (<i>Not Fixed</i>)
19	19	19	Building
20	20	20	Impact Attenuator/Crash Cushion
21	21	--	Bridge Pier or Abutment
--	--	21	Bridge Pier or Support
22	22	--	Bridge Parapet End
23	23	--	Bridge Rail
--	--	23	Bridge Rail (<i>Includes Parapet</i>)
24	24	24	Guardrail Face
25	25	25	Concrete Traffic Barrier
26	26	26	Other Traffic Barrier
27	27	--	Highway/Traffic Sign Post
28	28	--	Overhead Sign Support/Sign
29	29	--	Luminary/Light Support
30	30	--	Utility Pole
--	--	30	Utility Pole/Light Support
31	31	31	Other Post, Other Pole, or Other Support
32	32	32	Culvert
33	33	33	Curb
34	34	34	Ditch
35	35	--	Embankment - Earth
--	--	35	Embankment
36	36	--	Embankment - Rock, Stone, or Concrete
37	37	--	Embankment - Material Type Unknown
38	38	38	Fence
39	39	39	Wall
40	40	40	Fire Hydrant
41	41	41	Shrubbery
42	42	42	Tree (<i>Standing Only</i>)
43	43	43	Other Fixed Object
44	--	--	Pavement Surface Irregularity (<i>1993 Only</i>)
--	44	--	Pavement Surface Irregularity
--	--	44	Pavement Surface Irregularity (<i>Ruts, Potholes, Grates, etc.</i>)
45	--	--	Transport Device Used as Equipment (<i>1993-2003 Only</i>)
45	45	--	Working Construction, Maintenance or Utility Vehicles
--	--	45	Working Motor Vehicle
46	46	46	Traffic Signal Support
47	47	--	Vehicle Occupant Struck or Run Over by Own Vehicle (<i>Since 1997</i>)

V32 Most Harmful Event (continued)**Attribute Codes**

1982- 2003	2004- 2009	2010- Later	
48	48	--	Collision With Snow Bank (<i>Since 1997</i>)
--	--	48	Snow Bank
49	49	49	Ridden Animal or Animal-Drawn Conveyance (<i>Since 1998</i>)
50	50	50	Bridge Overhead Structure
--	51	--	Jackknife
--	--	51	Jackknife (<i>Harmful to This Vehicle</i>)
--	52	52	Guardrail End
--	53	53	Mail Box
--	54	--	Motor Vehicle Struck by Falling/Shifting Cargo or Anything Set in Motion by Another Motor Vehicle in Transport
--	--	54	Motor Vehicle In-Transport Strikes or is Struck by Cargo, Persons or Objects Set-in-Motion from/by Another Motor Vehicle In-Transport
--	55	--	Other Not in-Transport Motor Vehicle (<i>2005-2007 Only</i>)
--	55	55	Motor Vehicle in Motion Outside the Trafficway (<i>Since 2008</i>)
--	57	57	Cable Barrier (<i>Since 2008</i>)
--	--	58	Ground
--	--	59	Traffic Sign Support
--	60	--	Cargo/Equipment Loss or Shift
--	61	--	Equipment Failure (<i>Blown Tire, Brake Failure, etc.</i>)
--	62	--	Separation of Units
--	63	--	Ran Off Road - Right
--	64	--	Ran Off Road - Left
--	65	--	Cross Median/Centerline
--	66	--	Downhill Runaway
--	67	--	Vehicle Went Airborne
--	--	72	Cargo/Equipment Loss or Shift (<i>Harmful to This Vehicle</i>)
--	--	98	Not Reported
99	99	99	Unknown

V33 Related Factors- Vehicle Level

Definition: This element identifies factors related to this vehicle expressed by the investigating officer.

Additional Information: There are also crash-level-related factors in the Accident file, CF1, CF2, and CF3 and driver-related factors in the Vehicle file, namely DR_CF1, DR_CF2, DR_CF3 and (DR_CF4 since 1997). In addition there are person-related factors P_CF1, P_CF2, and P_CF3 in the person file. The SAS names change to DR_SF1 - DR_SF4 and P_SF1 - P_SF3 in 2010.

The FARS analyst may have used either of the two variables to code a related factor. One must test both variables to insure that the selected related factor is included.

These variables also appear in the Parkwork data set as PVEH_CF1 and PVEH_CF2 in 2009 and prior and it is PVEH_SC1 and PVEH_SC2 in 2010. The set of "Pre-existing Vehicle Defects" that had been collected under Related Factors- Vehicle Level is now captured in new precrash level data elements PC4 Contributing Circumstances, Motor vehicle (stored as SAS variable Factor.MFACTOR)

SAS Name: **VEH_CF1, VEH_CF2** **1975-2009**
VEH_SC1, VEH_SC2 **2010-Later**

Attribute Codes

1975- 1981	1982- 2009	2010- Later	
00	00	00	None
01	--	--	Tires and Wheels
--	01	--	Tires (<i>Does Not Include Wheels, See Value 16</i>)
02	02	--	Brake System
03	03	--	Steering System- Tie Rod, Kingpin, Ball Joint, etc.
04	04	--	Suspension- Springs, Shock Absorbers, MacPherson struts, Axle Bearing, Control Arms, etc.
05	05	--	Power Train (<i>Power Train/Engine, Since 2001</i>)- Universal Joint, Drive Shaft, Transmission, etc.
06	06	--	Exhaust System
07	07	--	Headlights
08	08	--	Signal Lights
09	09	--	Other Lights
10	10	--	Horn
11	11	--	Mirrors
12	12	--	Wipers
13	13	--	Driver Seating and Control
14	14	--	Body, Doors, Hood, Other
15	15	--	Trailer Hitch
--	16	--	Wheels
--	17	--	Air Bags (<i>Since 1995</i>)
--	18	--	Other Vehicle Defects
--	19	--	Safety Belts (<i>Since 2002</i>)

V33 Related Factors- Vehicle Level (continued)**Attribute Codes**

1975- 1981	1982- 2009	2010- Later	
--	31	--	Hit-and-Run Vehicle (1982-2008 Only)
--	32	32	Vehicle Registration for Handicapped
--	33	33	Vehicle Being Pushed by Non-Motorist
--	34	--	Vehicle Impact Point- the Result of Something Set in Motion (1998-2003 Only)
--	35	--	Reconstructed Vehicle (1998-2007)
--	35	35	Reconstructed/Altered Vehicle (Since 2008)
--	36	36	Electric/Alternative Fuel Vehicle (Since 1999)
--	37	37	Transporting Children to/from Head Start/Day Care (Since 2000)
--	38	38	Vehicle Went Airborne During Crash (2001-2003)
--	39	39	Highway Construction, Maintenance or Utility Vehicle, In Transport (Inside or Outside Work Zone) (Since 2002)
--	40	40	Highway Incident Response Vehicle (Since 2002)
--	41	41	Police Fire or EMS Vehicle Working at the Scene of an Emergency or Performing Other Traffic Control Activities (Since 2004)
--	42	42	Other Working Vehicle (Not Construction, Maintenance, Utility, Police, Fire, or EMS Vehicle, Since 2004)
--	43	--	Hazardous Materials/Cargo Released From This Vehicle (2005-2006)
--	44	44	Adaptive Equipment (Since 2007)
99	99	99	Unknown

V34 Fire Occurrence

Definition: This element indicates whether a fire in any way related to the crash occurred in this vehicle.

Additional Information: From 1975 to 1979 if an explosion occurred in the vehicle, with or without a fire, this variable would also be set to 1.

This variable also appears in the Person data set.

SAS Name: FIRE_EXP

Attribute Codes

<i>1975- 2007</i>	<i>2008</i>	<i>2009- Later</i>	
0	0	--	No Fire
--	--	0	No or Not Reported
1	1	--	Fire Occurred in This Vehicle during Crash
--	--	1	Yes
--	2	--	Fire Occurred in This Vehicle and Initiated Fire/Explosion in Another Vehicle

V100 Make Model Combined

Definition: This element represents the 5-digit combined codes of the variables MAKE and MODEL.

Additional Information: This variable also appears in the Parkwork data set as PMAK_MOD.

SAS Name: MAK_MOD

Attribute Codes***1975-Later***

See Appendix A: Vehicle Make/Model Designation.

V101 VIN Character 1

Definition: This element represents the first character in the VIN string.

Additional Information:

SAS Name: PVIN1

Attribute Codes

2010-Later

V102 VIN Character 2

Definition: This element represents the second character in the VIN string.

Additional Information:

SAS Name: PVIN2

Attribute Codes

2010-Later

V103 VIN Character 3

Definition: This element represents the third character in the VIN string.

Additional Information:

SAS Name: PVIN3

Attribute Codes

2010-Later

V104 VIN Character 4

Definition: This element represents the fourth character in the VIN string.

Additional Information:

SAS Name: PVIN4

Attribute Codes

2010-Later

V105 VIN Character 5

Definition: This element represents the fifth character in the VIN string.

Additional Information:

SAS Name: PVIN5

Attribute Codes

2010-Later

V106 VIN Character 6

Definition: This element represents the sixth character in the VIN 6 string.

Additional Information:

SAS Name: PVIN6

Attribute Codes

2010-Later

V107 VIN Character 7

Definition: This element represents the seventh character in the VIN string.

Additional Information:

SAS Name: PVIN7

Attribute Codes

2010-Later

V108 VIN Character 8

Definition: This element represents the eighth character in the VIN string.

Additional Information:

SAS Name: PVIN8

Attribute Codes

2010-Later

V109 VIN Character 9

Definition: This element represents the ninth character in the VIN string.

Additional Information:

SAS Name: PVIN9

Attribute Codes

2010-Later

V110 VIN Character 10

Definition: This element represents the tenth character in the VIN string.

Additional Information:

SAS Name: PVIN10

Attribute Codes

2010-Later

V111 VIN Character 11

Definition: This element represents the eleventh character in the VIN string.

Additional Information:

SAS Name: PVIN11

Attribute Codes

2010-Later

V112 VIN Character 12

Definition: This element represents the twelfth character in the VIN string.

Additional Information:

SAS Name: PVIN12

Attribute Codes

2010-Later

V113 VIN Vehicle Type

Definition: This element identifies the basic vehicle type.

Additional Information: See Appendix of the PC VINA User's Manual.

This variable also appears in the Person data set and in the Parkwork data set as PVINTYPE.

SAS Name: **VINTYPE**

Attribute Codes**2010-Later**

P	Passenger Vehicle
T	Truck
M	Motorcycle
U	Unknown

V114 VIN Make

Definition: This element provides the NCIC Standard Make Abbreviation.

Additional Information: See Appendix of the PC VINA User's Manual.

This variable also appears in the Person data set and in the Parkwork data set as PVINMAKE.

SAS Name: VINMAKE

Attribute Codes**2010-Later**

xxxx 4-Character Make Abbreviation

V115 VIN Model

Definition: The VIN Model, for automobiles, is obtained from the VINA program for automobiles of model year 1966 and later that have verifiable VIN numbers.

Additional Information: If one needs to select cars based on make and model the variable of choice is VINA_MOD rather than MAK_MOD.

This is a CHARACTER variable in UPPER CASE three characters long.

The VINA_MOD is only unique within the vehicle make. That is, different makes of vehicles can have the same VINA_MOD. To ensure that the correct vehicle is selected the variable MAKE must be used in conjunction with VINA_MOD. Both variables, VINA_MOD and MAKE, are in both the Vehicle file and the Person File.

There are two columns headed VINA CODE. For passenger cars, or what Polk calls passenger vehicles, the FARS variable VINA_MOD can be set to either the VINA code for the series name, i.e., the first column, or it can be set to the value of the sub-series name, the last column. Therefore one must search for values in both columns.

For trucks the first column labeled VINA CODE, series name, is the FARS variable SER_TR. When using the variable SER_TR all model names, last column are included. If one wishes to select a specific truck model one uses the FARS variable VINA_MOD set to the value in the last VINA CODE column.

See Appendix of the PC VINA User's Manual.

This variable also appears in the Person data set and in the Parkwork data set as PVINA_MOD.

SAS Name: VINA_MOD

Attribute Codes**1975-Later**

xxx 3-Character Model (Series) Abbreviation

V116 VIN Body Type

Definition: This element is a 2-character representation of the vehicle's body style.

Additional Information: This is a CHARACTER variable in UPPER CASE.

The VINA program decodes these data and partitions vehicles into three classes, passenger vehicles, trucks, and motorcycles.

This variable also appears in the Person data set and in the Parkwork data set as PVIN_BT.

SAS Name: **VIN_BT**

Attribute Codes

1982- 2009	2010- Later	
2D	2D	Passenger Vehicle Sedan 2-Door
2F	2F	Passenger Vehicle Formal Hardtop 2-Door
2H	2H	Passenger Vehicle Hatchback 2-Door
2L	2L	Passenger Vehicle Liftback 3-Door
2P	2P	Passenger Vehicle Pillard Hardtop 2-Door
2T	2T	Passenger Vehicle Hardtop 2-Door
2W	2W	Truck 2-Door Wagon/Sport Utility
2W	2W	Passenger Vehicle Wagon 2-Door
--	3B	Truck 3-Door Extended Cab/Chassis
--	3C	Truck 3-Door Extended Cab Pickup
3D	3D	Passenger Vehicle Runabout 3-Door
--	3P	Passenger Vehicle Coupe 3-Door
--	4B	Truck 4-Door Extended Cab/Chassis
--	4C	Truck 4-Door Extended Cab Pickup
4D	4D	Passenger Vehicle Sedan 4-Door
4H	4H	Passenger Vehicle Hatchback 4-Door
4L	4L	Passenger Vehicle Liftback 5-Door
4P	4P	Passenger Vehicle Pillard Hardtop 4-Door
4T	4T	Passenger Vehicle Hardtop 4-Door
4W	4W	Truck 4-Door Wagon/Sport Utility
4W	4W	Passenger Vehicle Wagon 4-Door
5D	5D	Passenger Vehicle Sedan 5-Door
8V	8V	Truck 8-Passenger Sport Van
AC	AC	Truck Auto Carrier
AM	AM	Passenger Vehicle Ambulance
AR	AR	Truck Armored Truck
AT	AT	Motorcycle All-Terrain
BU	BU	Bus
--	C4	Passenger Vehicle Coupe 4-Door
CB	CB	Truck Chassis and Cab
CB	CB	Passenger Vehicle Cab & Chassis (<i>Luv</i>)

V116 VIN Body Type (continued)

Attribute Codes

1982- 2009	2010- Later	
CC	CC	Truck Conventional Cab
CG	CG	Truck Cargo Van
CH	CH	Truck Crew Chassis
CL	CL	Truck Club Chassis
CM	CM	Truck Concrete or Transit Mixer
CP	CP	Truck Crew Pickup
CP	CP	Passenger Vehicle Coupe
CR	CR	Truck Crane
CS	CS	Truck Super Cab/Chassis Pickup
CU	CU	Truck Custom Pickup
CV	CV	Truck Convertible (<i>Jeep Commando, Suzuki Samurai, Dodge Dakota</i>)
CV	CV	Passenger Vehicle Convertible
CY	CY	Truck Cargo Cutaway
DP	DP	Truck Dump
DS	DS	Truck Tractor Truck (<i>Diesel</i>)
EC	EC	Truck Extended Cargo Van
EN	EN	Motorcycle Enduro
ES	ES	Truck Extended Sport Van
EV	EV	Truck Extended Van
EW	EW	Truck Extended Window Van
FB	FB	Truck Flat-bed or Platform
FC	FC	Truck Forward Control
FT	FT	Truck Fire Truck
GG	GG	Truck Garbage or Refuse
GL	GL	Truck Gliders
GN	GN	Truck Grain
HB	HB	Passenger Vehicle Hatchback Number Doors Unknown
HO	HO	Truck Hopper
HR	HR	Passenger Vehicle Hearse
HT	HT	Passenger Vehicle Hardtop Number Doors Unknown
IC	IC	Truck Incomplete Chassis
IE	IE	Truck Incomplete Ext Van
--	IN	Passenger Vehicle Incomplete Passenger
LB	LB	Passenger Vehicle Liftback
LG	LG	Truck Logger
LL	LL	Truck Suburban & Carry-All
LM	LM	Passenger Vehicle Limousine
--	LM	Truck Limousine
MH	MH	Truck Motorized Home
MK	MK	Motorcycle Mini-Bike
MN	MM	Motorcycle Mini Moto Cross
MM	MP	Motorcycle Moped

V116 VIN Body Type (continued)

Attribute Codes

1982- 2009	2010- Later	
MP	MP	Truck Multipurpose
MR	MR	Motorcycle Mini Road/Trail
MS	MS	Motorcycle Motor Scooter
MV	MV	Truck Maxi-Van
--	MW	Truck Maxi Wagon
MX	MX	Motorcycle Moto Cross
MY	MY	Truck Motorized Cutaway
MY	MY	Motorcycle Mini-Cycle
NB	NB	Passenger Vehicle Notchback
--	P2	Passenger Vehicle 2-Passenger Low Speed
--	P2	Passenger Vehicle 4-Passenger Low Speed
PC	PC	Truck Club Cab Pickup
PD	PD	Truck Parcel Delivery
PK	PK	Truck Pickup
PK	PK	Passenger Vehicle Pickup, Truck Commonly Registered Passengers
PM	PM	Truck Pickup with Camper Mounted on Bed
PN	PN	Truck Panel
PS	PS	Truck Super Cab Pickup
RC	RC	Motorcycle Racer
PN	PN	Passenger Vehicle Panel, Truck Commonly Registered as Passengers
RD	RD	Truck Roadster (<i>Jeep, Jeep Commando</i>)
RD	RD	Passenger Vehicle Roadster
RS	RS	Motorcycle Road/Street
RT	RT	Motorcycle Road/Trail
S1	S1	Truck One-Seat
S2	S2	Truck Two-Seat
SB	SB	Passenger Vehicle Sport Hatchback
SC	SC	Passenger Vehicle Sport Coupe
SD	SD	Passenger Vehicle Sedan, number doors unknown
SN	SN	Truck Step Van
SP	SP	Truck Sport Pickup
ST	ST	Truck Stake or Rack
SV	SV	Truck Sports Van
SV	SV	Passenger Vehicle Sport Van
SW	SW	Passenger Vehicle Station Wagon
SW	SW	Truck Station Wagon (<i>Jeep Wagoneer, etc.</i>)
T	T	Motorcycle Dirt
TB	TB	Truck Tilt Cab
TL	TL	Truck Tilt Tandem
TL	TL	Motorcycle Trail/Dirt
TM	TM	Truck Tandem
TN	TN	Truck Tank

V116 VIN Body Type (continued)

Attribute Codes**1982- 2010-
2009 Later**

TR	TR	Motorcycle Trails
TR	TR	Truck Tractor (<i>Gasoline</i>)
UT	UT	Passenger Vehicle Utility, truck commonly registered as passenger
UT	UT	Truck Utility (<i>Blazer, Jimmy, Scout, etc.</i>)
VC	VC	Truck Van Camper
VD	VD	Truck Display Van
VN	VN	Truck Van
VT	VT	Truck Vanette (<i>Includes Metro and Handy Van</i>)
VW	VW	Truck Window Van
WK	WK	Truck Tow Truck Wrecker
WW	WW	Truck Wide Wheel Wagon
WW	WW	Passenger Vehicle Wide-Wheel Wagon
XT	XT	Truck Travel-all
YY	YY	Truck Cutaway
99	99	Unknown

V117 VIN Model Year

Definition: This element represents the 2-digit model year of the vehicle.

Additional Information: This variable also appears in the Person data set and in the Parkwork data set as PVINMDYR.

SAS Name: VINMODYR

Attribute Codes***2010-Later***

xx 2-Digit Model Year

V118 Curb Weight

Definition: This element provides the base weight for the vehicle model.

Additional Information: This variable also appears in the Person data set and in the Parkwork data set as PVIN_WGT.

SAS Name: VIN_WGT

Attribute Codes***1975-Later***

0	Not Available
1-9998	Actual weight of Automobile in Pounds
9999	Value Not Coded

More Information on [VIN Weight- Auto](#)

V119 Wheelbase Short

Definition: The shortest wheelbase respectively for the manufactured model as determined by the VINA program for automobiles.

Additional Information: This variable also appears in the Person data set and in the Parkwork data set as PWHLBS_SH.

SAS Name: **WHLBS_SH**

Attribute Codes**1975-Later**

0000	Value Not Available from the VINA Program
1-9998	Actual Value in Inches
9999	Value Not Coded

V120 Wheelbase Long

Definition: The longest wheelbase respectively for the manufactured model as determined by the VINA program for automobiles.

Additional Information: This variable also appears in the Person data set and in the Parkwork data set as PWHLBS_LG.

SAS Name: **WHLBS_LG**

Attribute Codes**1975-Later**

0000	Value Not Available from the VINA Program
1-9998	Actual Value in Inches
9999	Value Not Coded

V121 Fuel Code

Definition: This element identifies the fuel type for a vehicle determined by the manufacturer specification and recommendation.

Additional Information: This is RLPolk VINA decode data. Prior to 2010, this variable was derived for trucks only. Since 2010 this element is coded for all vehicles.

This variable also appears in the Person data set and in the Parkwork data set as PFUECODE.

SAS Name: **FLDCD_TR** 1975-2009
FUELCODE 2010-Later

Attribute Codes

1975- 2009	2010- Later	
--	B	Electric and Gasoline Hybrid Engine
C	C	Gasoline Engine That Can Be Easily Converted to Gaseous-Powered Engine (Powered by Natural Gas, Propane, etc.)
D	D	Diesel
E	E	Electric
F	F	Flexible Fuel
G	G	Gas
H	H	Ethanol Fuel Only
M	M	Methanol Gas Only
N	N	Compressed Natural Gas
P	P	Propane
9	9	Unknown

V122 VIN Truck Series

Definition: This element identifies the model (series) of the truck.

Additional Information: This material comes from analysis of the Vehicle Identification Number. This is a CHARACTER variable in UPPER CASE three characters long.

The values for SER_TR are contained in the Appendix of PC VINA User's Manual. They are the first column headed VINA CODE for the series name. When using the variable SER_TR all model names, in the last column are included. If one wishes to select a specific truck model one uses the FARS variable VINA_MOD set to the value in the last column headed VINA CODE.

See Appendix of the PC VINA User's Manual.

This variable also appears in the Person data set and in the Parkwork data set as PSER_TR.

SAS Name: SER_TR

Attribute Codes**1975-Later**

xxx 3-Character Model (Series) Abbreviation

V123 Truck Weight Rating

Definition: This element provides weight ranges for trucks based on manufacturer specifications.

Additional Information: For model year 1966 and newer trucks.

Often coded as 9 for buses.

This variable also appears in the Person data set and in the Parkwork data set as PWGTCD_TR.

SAS Name: **WGTCD_TR**

Attribute Codes**1975-Later**

- | | |
|---|---------------------|
| 1 | 6,000 lbs or Less |
| 2 | 6,001 - 10,000 lbs |
| 3 | 10,001 - 14,000 lbs |
| 4 | 14,001 - 16,000 lbs |
| 5 | 16,001 - 19,500 lbs |
| 6 | 19,501 - 26,000 lbs |
| 7 | 26,001 - 33,000 lbs |
| 8 | 33,001 and Up |
| 9 | Unknown |

V124 Motorcycle Engine Displacement (CC)

Definition: This is the piston bore measured in cubic centimeters. This is a numeric value (example, Honda 160 cc engine). This field is 4 positions long.

Additional Information: This variable also appears in the Person data set and in the Parkwork data set as PMCYCL_DS.

SAS Name: **MCYCL_DS**

Attribute Codes**1975-Later**

xxxx Actual Displacement (cc)

Motorcycle Type (discontinued)

Definition: This is the VINA Body Type (example, Dirt Bike). This information is in the VINA documentation.

Additional Information: This variable was discontinued in 1981.

SAS Name: **MCYCL_TY**

Attribute Codes**1975-1981**

??

V125 VIN Length

Definition: This is the actual length of the vehicle identification number

Additional Information: This variable also appears in the Parkwork data set as PVIN_LNGT.

SAS Name: VIN_LNGT

Attribute Codes***1981-Later***

1-17	Actual Value
99	Unknown VIN Length

V150 Fatalities in Vehicle (Number)

Definition: The number of fatalities that occurred in the vehicle.

Additional Information: The variable FATALS in the Accident file, under the heading Fatalities, provides the number of deaths for the entire crash.

This is a derived variable and is not coded on the form directly. In 1976, this value is always set to 0.

This variable also appears in the Parkwork data set as PDEATHS.

SAS Name: DEATHS

Attribute Codes**1975-Later**

01-99 Number of Fatalities that Occurred in the Vehicle.

V151 Driver Drinking

Definition: This is a derived variable. Data from the Vehicle file are analyzed and if there is "sufficient information" to conclude that a driver was drinking, i.e., positive BAC data or police-reported alcohol involvement, then a driver is classified as drinking.

Additional Information: Note that alcohol data is often missing. For that reason this variable may under-count the actual number of drinking drivers. For detailed analysis of alcohol involvement, the Alcohol files should be used.

A driver who is charged with an alcohol violation does not by itself make the driver a "drinking driver" by this definition.

SAS Name: **DR_DRINK**

Attribute Codes**1975-Later**

- 0 No Drinking
- 1 Drinking
- 9 Unknown

D4 Driver Presence

Definition: This element indicates whether a driver was present in this vehicle at the onset of the unstabilized situation.

Additional Information:

SAS Name: DR_PRES

Attribute Codes

1975- 1977	1978- 2008	2009- Later	
--	--	0	No Driver Present/Not Applicable
1	1	--	Driver Operated Vehicle
--	--	1	Yes
2	--	--	No Driver
--	2	--	Driverless (<i>No Driver</i>)
--	3	--	Driver Left Scene
--	4	--	Motor Vehicle not In-Transport (<i>Parked/Stopped Off Roadway/ Working Motor Vehicle/In Motion Outside Trafficway, 2008 Only</i>)
--	4	--	Motor Vehicle not In-Transport (<i>Parked/Stopped Off Roadway/Working/ In Motion Outside Trafficway, 2005-2007</i>)
9	9	9	Unknown

D5 Driver's License State

Definition: This element identifies the state of issue for the license held by this driver.

Additional Information:

SAS Name: L_STATE

Attribute Codes**1975-Later**

01 Alabama	30 Montana
02 Alaska	31 Nebraska
03 American Samoa	32 Nevada
04 Arizona	33 New Hampshire
05 Arkansas	34 New Jersey
06 California	35 New Mexico
08 Colorado	36 New York
09 Connecticut	37 North Carolina
10 Delaware	38 North Dakota
11 District of Columbia	39 Ohio
12 Florida	40 Oklahoma
13 Georgia	41 Oregon
14 Guam	42 Pennsylvania
15 Hawaii	43 Puerto Rico
16 Idaho	44 Rhode Island
17 Illinois	45 South Carolina
18 Indiana	46 South Dakota
19 Iowa	47 Tennessee
20 Kansas	48 Texas
21 Kentucky	49 Utah
22 Louisiana	50 Vermont
23 Maine	51 Virginia
24 Maryland	52 Virgin Islands (<i>Since 2004</i>)
25 Massachusetts	53 Washington
26 Michigan	54 West Virginia
27 Minnesota	55 Wisconsin
28 Mississippi	56 Wyoming
29 Missouri	
00 No Driver Present (<i>Since 2010</i>)	
93 Indian Nation (<i>Since 2009</i>)	
94 Military (<i>1975-2006</i>)	
94 U.S. Government (<i>Since 2007</i>)	
95 Canada	
96 Mexico	
97 Other Foreign Country	
98 Not reported (<i>Since 2010</i>)	
99 Unknown	

D6 Driver's ZIP Code

Definition: This element identifies the zip code of this driver's area of residence.

Additional Information: The element name was "Driver ZIP Code" from 1987 to 2008. The element name has been changed to "Driver's ZIP Code" since 2009.

SAS Name: DR_ZIP

Attribute Codes

1987- 2009	2010- Later	
00000	00000	Not Resident of U. S. or Territories
xxxxx	xxxxx	Five Numeric, Actual Values
--	99998	No Driver Present
99999	99999	Unknown

D7 Non-CDL License Type/Status

D7A Non-CDL License Type

Definition: This element identifies the type license held by this driver at the time of the crash.

Additional Information:

SAS Name: L_TYPE

Attribute Codes**2004-Later**

- 0 Not Licensed
- 1 Full Driver License
- 2 Intermediate Driver License
- 7 Learner's Permit
- 8 Temporary License
- 9 Unknown License Type

D7B Non-CDL License Status

Definition: This element identifies the status of the license at the time of the crash.

Additional Information: For 1975-1981, values 3 and 7 make up the valid license category. For 1982-1986, values 2, 7, and 8 are all valid license categories. For 1987-1992, values 5, 6, 7 and 8 make up the valid license category.

SAS Name: L_STATUS

Attribute Codes**1975-1981**

- 0 None Required
- 1 No License, License Required
- 2 Licensed, But Not for This Type Vehicle
- 3 Valid License for This Type Vehicle
- 4 Suspended License
- 5 Revoked License
- 6 Expired License
- 7 Learner's Permit
- 9 Unknown

D7B Non- CDL License Status (continued)**Attribute Codes**

1982- 1986	1987- 1992	1993- 2003	2004- 2009	2010- Later	
0	--	--	--	--	None Required
--	0	0	0	0	Not Licensed
1	--	--	--	--	None
2	--	--	--	--	Valid
3	1	1	1	1	Suspended
4	2	2	2	2	Revoked
5	3	3	3	3	Expired
6	4	4	4	4	Cancelled or Denied
--	5	--	--	--	Single-Class License
--	6	--	--	--	Multiple-Class License
--	--	6	6	6	Valid License
7	7	--	7	--	Learner's Permit
--	--	7	--	--	Learner's Permit/Restricted
8	8	8	--	--	Temporary
9	9	9	--	--	Unknown
--	--	--	9	9	Unknown License Status

More Information on [Driver License Status/Type](#)

D8 Commercial Motor Vehicle License Status

Definition: This element indicates the status for a driver's Commercial Driver's License (CDL) if applicable.

Additional Information:

SAS Name: **CDL_STAT**

Attribute Codes**1991-1992**

0	No Commercial Driver's License (<i>CDL Not Required</i>)
1	No CDL (<i>CDL Required</i>)
2	No CDL (<i>Unknown if CDL Required</i>)
3	CDL (<i>CDL Not Required</i>)
4	CDL (<i>CDL REQUIRED</i>)
5	CDL (<i>Unknown if CDL Required</i>)
6	Unknown CDL (<i>CDL Not Required</i>)
7	Unknown CDL (<i>CDL Required</i>)
9	Unknown CDL (<i>Unknown if CDL Required</i>)

**1993-2009 2010-
2009 Later**

0	00	No Commercial Driver's License (<i>CDL</i>)
1	01	Suspended
2	02	Revoked
3	03	Expired
4	04	Cancelled or Denied
5	05	Disqualified
6	06	Valid
7	07	Learner's Permit
8	08	Other Not-Valid
9	--	Unknown CDL
--	98	Not Reported
--	99	Unknown

D9 Compliance with CDL Endorsements

Definition: This element indicates whether the vehicle driven at the time of the crash required endorsement(s) on a Commercial Driver's License (CDL) and whether this driver was complying with the CDL endorsements.

Additional Information: Data was not collected prior to 1991.

SAS Name: **L_ENDORS**

Attribute Codes

<i>1991- 2009</i>	<i>2010- Later</i>	
0	0	No Endorsements Required For This Vehicle
1	1	Endorsement(s) Required, Complied With
2	2	Endorsement(s) Required, Not Complied With
3	3	Endorsement(s) Required, Compliance Unknown
--	8	Not Reported
9	9	Unknown, if Required

D10 License Compliance with Class of Vehicle

Definition: This element refers to the type of license possessed or not possessed by the driver for the class of vehicle being driven at the time of the crash.

Additional Information: Data not available before 1982.

Since 2004, this variable addresses license compliance with class of vehicle.

SAS Name: **L_CL_VEH** **1982-1986**
L_COMPL **1987-Later**

1982-1986

- 0 No License Required
- 1 No License, License Required
- 2 Valid License for This Class Vehicle Only
- 3 One Valid License, but Not for This Class Vehicle
- 4 Multiple Class Licenses, Valid License for This Class Vehicle
- 5 Multiple Class Licenses, Not Valid License for This Class Vehicle
- 9 Unknown

1987- 1992	1993- 2009	2010- Later	
-----------------------	-----------------------	------------------------	--

- | | | | |
|----|----|---|---|
| 0 | 0 | 0 | Not Licensed |
| 1 | 1 | 1 | No License Required for This Class Vehicle |
| 2 | 2 | 2 | No Valid License for This Class Vehicle |
| 3 | 3 | 3 | Valid License for This Class Vehicle |
| -- | -- | 7 | Not Reported |
| -- | 8 | 8 | Unknown if CDL and/or CDL Endorsement Required for This Vehicle |
| 9 | 9 | 9 | Unknown |

More Information on [Driver License Type Compliance](#)

D11 Compliance with License Restrictions

Definition: This element indicates whether a driver was compliant with restrictions on their license.

Additional Information:

SAS Name: L_RESTRI

Attribute Codes

1975- 2009	2010- Later	
0	0	No Restrictions or Not Applicable (<i>i.e., License is Suspended, Revoked, Expired or Not For This Type of Vehicle</i>)
1	1	Restrictions Complied With
2	2	Restrictions Not Complied With
3	3	Restrictions, Compliance Unknown
--	8	Not Reported
9	9	Unknown

D12 Driver Height

Definition: This element identifies this driver's height (in inches).

Additional Information: Minimum height 2 feet = 24 inches, Maximum height 8 feet 11 inches = 107 inches

SAS Name: DR_HGT

Attribute Codes

1998- 2001	2002- Later	
24-107	24-96	Actual Height in Inches
998	98	Other
999	99	Unknown

D13 Driver Weight

Definition: This element identifies this driver's weight (in pounds).

Additional Information:

SAS Name: DR_WGT

Attribute Codes***1998-Later***

40-700	Actual Weight in Pounds
998	Other
999	Unknown

D14 Previous Recorded Crashes

Definition: This element records any previous crashes for this driver that occurred within three years of the crash date.

Additional Information:

SAS Name: `PREV_ACC`

Attribute Codes

1975- 1993	1994- Later	
00	00	None
01-97	01-97	Actual Value
98	--	CDL Disqualified
--	98	Not Reported on Driving Record
99	99	Unknown

D15 Previous Recorded Suspensions and Revocations

Definition: This element records any previous license suspensions or revocations for this driver that occurred within three years of the crash date.

Additional Information: If a driver has been disqualified for a CDL this event is recorded in Previous Recorded Suspensions and Revocations.

SAS Name: **PREV_SUS**

Attribute Codes

1975- 1993	1994- Later	
00	00	None
01-97	01-97	Actual Value
98	--	CDL Disqualified
99	99	Unknown

D16 Previous DWI Convictions

Definition: This element records any previous DWI convictions for this driver that occurred within three years of the crash date.

Additional Information:

SAS Name: `PREV_DWI`

Attribute Codes

1975- 1993	1994- Later	
00	00	None
01-97	01-97	Actual Value
98	--	CDL Disqualified
99	99	Unknown

D17 Previous Speeding Convictions

Definition: This element records any previous speeding convictions for this driver that occurred within three years of the crash date.

Additional Information: Speeding violations count going too slow, as well as going too fast.

SAS Name: `PREV_SPD`

Attribute Codes

1975- 1993	1994- Later	
00	00	None
01-97	01-97	Actual Value
98	--	CDL Disqualified
99	99	Unknown

D18 Previous Other Harmful Moving Violation Convictions

Definition: This element records any other previous moving violations or convictions for this driver that occurred within three years of the crash date.

Additional Information:

SAS Name: `PREV_OTH`

Attribute Codes

<i>1975- 1993</i>	<i>1994- Later</i>	
00	00	None
01-97	01-97	Actual Value
98	--	CDL Disqualified
99	99	Unknown

D19 Date of First Crash, Suspension or Conviction

D19A Month

Definition: This element identifies the month of the first crash, suspension, or conviction for this driver that occurred within three years of the crash date.

Additional Information:

SAS Name: FIRST_MO

Attribute Codes**1975-
Later**

00	No Record
01	January
02	February
03	March
04	April
05	May
06	June
07	July
08	August
09	September
10	October
11	November
12	December
99	Unknown

D19B Year

Definition: This element identifies the year of the first crash, suspension, or conviction for this driver that occurred within three years of the crash date.

Additional Information:

SAS Name: FIRST_YR

Attribute Codes**1975- 1998-
1997 Later**

00	0000	No Record
xx	xxxx	Actual Year
99	9999	Unknown

D20 Date of Last Crash, Suspension or Conviction

D20A Month

Definition: This element identifies the month of the last crash, suspension, or conviction for this driver that occurred within three years of the crash date.

Additional Information:

SAS Name: LAST_MO

Attribute Codes**1975-
Later**

00	No Record
01	January
02	February
03	March
04	April
05	May
06	June
07	July
08	August
09	September
10	October
11	November
12	December
99	Unknown

D20B Year

Definition: This element identifies the year of the last crash, suspension, or conviction for this driver that occurred within three years of the crash date.

Additional Information:

SAS Name: LAST_YR

Attribute Codes**1975- 1998-
1997 Later**

00	0000	No Record
xx	xxxx	Actual Year
99	9999	Unknown

D21 Violations Charged

Definition: This element identifies violations charged to this driver in this crash.

Additional Information: This variable was changed in 2010 to identify all violations charged in the crash and was therefore moved to its own data set, Violatn.

SAS Name: **VIOL_CHG** **1975-1996**
VIOLCHG1, VIOLCHG2, VIOLCHG3 **1997-2009**

Attribute Codes

1975-1981	1982-1996	
0	0	None
1	--	Yes
--	1	Alcohol or Drugs
2	--	Pending
--	2	Speeding
--	3	Alcohol or Drugs and Speeding
--	4	Reckless Driving
--	5	Driving With Suspended or Revoked License
--	6	Other Moving Violation
--	7	Non-Moving Violation
--	8	Violation, Type Unknown or Other Violation
9	9	Unknown

1997-2009

00 None

RECKLESS/CARELESS/HIT-AND-RUN OFFENSES

- 01 Manslaughter or Homicide
- 02 Willful Reckless Driving; Driving to Endanger; Negligent Driving
- 03 Unsafe Reckless (*Not Willful, Wanton Reckless*) Driving
- 04 Inattentive, Careless, Improper Driving
- 05 Fleeing or Eluding Police
- 06 Fail to Obey Police, Fireman, Authorized Person Directing Traffic
- 07 Hit-and-Run, Fail to Stop After Crash
- 08 Fail to Give Aid, Information, Wait for Police after Crash
- 09 Serious Violation Resulting in Death

D21 Violations Charged (continued)**1997-2009***IMPAIRMENT OFFENSES*

- 11 Driving While Intoxicated (*Alcohol or Drugs*) or BAC above Limit (*Any Detectable BAC for CDLs*)
- 12 Driving While Impaired; Driving Under Influence of Substance Not Intended to Intoxicate
- 13 Driving under Influence of Substance not intended to intoxicate
- 14 Drinking While Operating
- 15 Illegal Possession of Alcohol or Drugs
- 16 Driving With Detectable Alcohol
- 18 Refusal to Submit to Chemical Test
- 19 Alcohol, Drug, or Impairment Violations Generally

SPEED-RELATED OFFENSES

- 21 Racing
- 22 Speeding (*Above the Speed Limit*)
- 23 Speed Greater Than Reasonable and Prudent (*Not Necessarily Over the Limit*)
- 24 Exceeding Special Speed Limit (*e.g., for Trucks, Buses, Cycles, or on Bridge, in School Zone, etc.*)
- 25 Energy Speed (*Exceeding 55 mph, Non-Pointable*)
- 26 Driving Too Slowly
- 29 Speed-Related Violations Generally

RULES OF THE ROAD – TRAFFIC SIGN & SIGNALS

- 31 Fail to Stop for Red Signal
- 32 Fail to Stop for Flashing Red
- 33 Violation of Turn on Red (*Fail to Stop & Yield, Yield to Pedestrians before Turning*)
- 34 Fail to Obey Flashing Signal (*Yellow or Red*)
- 35 Fail to Obey Signal Generally
- 36 Violate RR Grade Crossing Device/Regulations
- 37 Fail to Obey Stop Sign
- 38 Fail to Obey Yield Sign
- 39 Fail to Obey Traffic Control Device Generally

RULES OF THE ROAD – TURNING, YIELDING, SIGNALING

- 41 Turn in Violation of Traffic Control (*Disobey Signs, Turn Arrow or Pavement Markings; this is not a Right-on-Red violation*)
- 42 Improper Method & Position of Turn (*Too Wide, Wrong Lane*)
- 43 Fail to Signal for Turn or Stop
- 45 Fail to Yield to Emergency Vehicle
- 46 Fail to Yield Generally
- 48 Enter Intersection When Space Insufficient
- 49 Turn, Yield, Signaling Violations Generally

D21 Violations Charged (continued)

1997-2009*RULES OF THE ROAD – WRONG SIDE, PASSING & FOLLOWING*

- 51 Driving Wrong Way on One-Way Road
- 52 Driving on Left, Wrong Side of Road Generally
- 53 Improper, Unsafe Passing
- 54 Pass on Right (*Drive off Pavement to Pass*)
- 55 Pass Stopped School Bus
- 56 Fail to Give Way When Overtaken
- 58 Following Too Closely
- 59 Wrong Side, Passing, Following Violations Generally

RULES OF THE ROAD – LANE USAGE

- 61 Unsafe or Prohibited Lane Change
- 62 Improper Use of Lane (*Enter of 3-Lane Road, HOV Designated Lane*)
- 63 Certain Traffic to Use Right Lane (*Trucks, Slow Moving, etc.*)
- 66 Motorcycle Lane Violations (*More than two per Lane, Riding Between Lanes, etc.*)
- 67 Motorcyclist Attached to another Vehicle
- 69 Lane Violations Generally

NON-MOVING – LICENSE & REGISTRATION VIOLATIONS

- 71 Driving While License Withdrawn
- 72 Other Driver License Violations
- 73 Commercial Driver Violations
- 74 Vehicle Registration Violations
- 75 Fail to Carry Insurance Card
- 76 Driving Uninsured Vehicle
- 79 Non-Moving Violations Generally

EQUIPMENT

- 81 Lamp Violations
- 82 Brake Violations
- 83 Failure to Require Restraint Use (*by Self or Passenger*)
- 84 Motorcycle Equipment Violations (*Helmet, Special Equipment*)
- 85 Violation of Hazardous Cargo Regulations
- 86 Size, Weight, Load Violations
- 89 Equipment Violations Generally

OTHER VIOLATIONS

- 91 Parking
- 92 Theft, Unauthorized Use of Motor Vehicle
- 93 Driving Where Prohibited (*Sidewalk, Limited Access, Off Truck Route*)
- 98 Other Moving Violation
- 99 Unknown Violation

D22 Speed Related

Definition: This element indicates whether the driver's speed was related to the crash as identified by law enforcement.

Additional Information:

SAS Name: **SPEEDREL**

Attribute Codes***2009-Later***

- 0 No
- 1 Yes
- 9 Unknown

More Information on [Speeding](#)

D24 Related Factors- Driver Level

Definition: This element identifies factors related to this driver expressed by the investigating officer.

Additional Information: There are also crash-level-related factors in the Accident File, CF1, CF2, and CF3; vehicle-related-factors, namely VEH_CF1 and VEH_CF2 (SAS names changed to be VEH_SC1 and VEH_SC2 in 2010) and person-related-factors, P_CF1, P_CF2, and P_CF3 (SAS names changed to P_SF1, P_SF2, and P_SF3 in 2010).

The FARS analyst may have used any of the three variables to code a related factor. One must test all three variables to insure that the selected related factor is included.

The person-related-factors P_CF1, P_CF2, and P_CF3 are all set to 0 for drivers.

Early files are not consistent with the documentation of the time. The following interpretation is suggested for current/future analysis.

A police pursuit is an event that is initiated when a law enforcement officer, operating an authorized emergency vehicle, gives notice to stop (either through the use of visual or audible emergency signals or a combination of emergency devices) to a motorist who the officer is attempting to apprehend and that motorist fails to comply with the signal by either maintaining speed, increasing speed, or taking other evasive action to elude the officer's continued attempts to stop the motorist. This is recorded if any Related Factor - Driver Level, DR_CF1, DR_CF2 or DR_CF3 is coded as 37.

From 1975 to 1981, see related factors crash level, CF1...CF3 for attributes under "AVOIDING, SWERVING, OR SLIDING DUE TO", "VISION OBSCURED BY"

Some information that had been collected under Related Factors- Driver Level is now captured in D24, Condition (Impairment) at Time of Crash (Driver).

SAS Name:	DR_CF1, DR_CF2, DR_CF3	1975-1996
	DR_CF1, DR_CF2, DR_CF3, DR_CF4	1997-2009
	DR_SF1, DR_SF2, DR_SF3, DR_SF4	2010-Later

Attribute Codes**1975-1981**

00 None

PHYSICAL/MENTAL CONDITION

01 Drowsy, Sleepy, Asleep, Fatigued

02 Ill, Blackout

03 Depression

04 Reaction to Drugs- Medication

05 Other Drugs (*Marijuana, Cocaine, etc.*)

06 Inattentive (*Talking, Eating, etc.*)

07 Physical Impairments

08 Died Prior to Crash

D24 Related Factors- Driver Level (continued)

Attribute Codes**1975-1981***MISCELLANEOUS CAUSES*

- 20 Leaving Vehicle Unattended with Engine Running Leaving Vehicle Unattended in Roadway
- 21 Overloading or Improper Loading of Vehicle with Passengers or Cargo
- 22 Towing or Pushing Vehicle Improperly
- 23 Failing to Dim Lights or to Have Lights on When Required
- 24 Operating Without Required Equipment
- 25 Creating Unlawful Noise or using Equipment Prohibited by Law
- 26 Following Improperly
- 27 Improper or Erratic Lane Changing
- 28 Failure to Keep in Proper Lane or Running off Road
- 29 Illegal Driving on Road Shoulder, in Ditch or Sidewalk or on Median
- 30 Making Improper Entry to or Exit from Trafficway
- 31 Starting or Backing Improperly
- 32 Opening Vehicle Closure into Moving Traffic or Vehicle is in Motion
- 33 Passing Where Prohibited by Posted Signs, Pavement Markings, Hill or Curve, or School Bus Displaying Warning Not to Pass
- 34 Passing on Wrong Side
- 35 Passing with Insufficient Distance or Inadequate Visibility or Failing to Yield to Overtaking Vehicle
- 36 Operating the Vehicle in an Erratic, Reckless, Careless, or Negligent Manner
- 37 High-Speed Chase with Police in Pursuit (*since 1978*)
- 38 Failure to Yield Right of Way
- 39 Failure to Obey Traffic Signs, Traffic Control Devices or Traffic Officers, Failure to Observe Safety Zone
- 40 Passing Through or Around Barrier
- 41 Failure to Observe Warnings or Instructions on Vehicle Displaying Them
- 42 Failure to Signal Intentions
- 43 Giving Wrong Signal
- 44 Driving Too Fast for Conditions or in Excess of Posted Speed Limit
- 45 Driving Less Than Posted Maximum
- 46 Operating at Erratic or Suddenly Changing Speeds
- 47 Making Right Turn from Left Turn-Lane; Making Left-Turn from Right-Turn Lane
- 48 Making Improper Turn
- 49 Failure to Comply With Physical Restrictions of License
- 50 Driving Wrong Way on One-Way Trafficway
- 51 Driving on Wrong Side of Road
- 52 Operator Inexperience
- 53 Unfamiliar With Roadway
- 54 Stopping in Roadway (*since 1979*)
- 99 Unknown

D24 Related Factors- Driver Level (continued)**Attribute Codes**

**1982- 2010-
2009 Later**

00 00 None

PHYSICAL/MENTAL CONDITION

01 -- Drowsy, Sleepy, Asleep, Fatigued
 02 -- Ill, Passed Out/Blackout
 03 -- Emotional (e.g., Depression, Angry, Disturbed)
 04 04 Reaction to or Failure to Take Drugs/Medication
 05 -- Other Drugs (*Marijuana, Cocaine, etc., 1982-1994 Only*)
 05 -- Under the Influence of Alcohol, Drugs, or Medication (*Since 2003*)
 06 -- Inattentive/Careless (*Talking, Eating, Car Phones, etc.*)
 07 -- Restricted to Wheelchair
 08 -- Paraplegic (*1982-1994 Only, See Element 11*)
 08 08 Road Rage/Aggressive Driving (*Since 2004*)
 09 -- Impaired Due to Previous Injury
 10 -- Deaf (*1982-1994 Only*)
 11 -- Other Physical Impairment (*Includes Paraplegic Since 1995*)
 12 12 Mother of Dead Fetus
 13 13 Mentally Challenged (*Since 1995*)
 14 -- Failure to Take Drugs/Medication (*1995-2004*)
 15 15 Seat Back Not in Normal Position, Seat Back Reclined (*Since 2002*)
 16 16 Police of Law Enforcement Officer (*Since 2002*)

MISCELLANEOUS FACTORS

17 -- Running off Road (*2000-2003 Only*)
 18 18 Traveling on Prohibited Trafficways (*Since 1995*)
 19 19 Legally Driving on Suspended or Revoked License
 20 20 Leaving Vehicle Unattended with Engine Running; Leaving Vehicle Unattended in Roadway
 21 21 Overloading or Improper Loading of Vehicle with Passenger or Cargo
 22 22 Towing or Pushing Vehicle Improperly
 23 23 Failing to Dim Lights or to Have Lights on When Required
 24 24 Operating Without Required Equipment
 25 -- Creating Unlawful Noise or Using Equipment Prohibited by Law
 26 26 Following Improperly
 27 27 Improper or Erratic Lane Changing
 28 -- Failure to Keep in Proper Lane or Running off Road (*1982-1999 Only*)
 28 28 Failure to Keep in Proper Lane (*Since 2000*)
 29 29 Illegal Driving on Road Shoulder, in Ditch, or Sidewalk, or on Median
 30 30 Making Improper Entry to or Exit from Trafficway
 31 31 Starting or Backing Improperly
 32 32 Opening Vehicle Closure into Moving Traffic or Vehicle is in Motion
 33 33 Passing Where Prohibited by Posted Signs, Pavement Markings, Hill or Curve, or School Bus Displaying Warning Not to Pass

D24 Related Factors- Driver Level (continued)**Attribute Codes**

1982- 2009	2010- Later	
34	34	Passing on Wrong Side
35	35	Passing with Insufficient Distance or Inadequate Visibility or Failing to Yield to Overtaking Vehicle
36	36	Operating the Vehicle in an Erratic, Reckless, Careless or Negligent Manner or Operating at Erratic or Suddenly Changing Speeds
37	37	High-Speed Chase with Police in Pursuit (<i>See Police Pursuit Note</i>)
38	38	Failure to Yield Right of Way
39	39	Failure to Obey Traffic Actual Signs, Traffic Control Devices or Traffic Officers, Failure to Observe Safety Zone Traffic Laws
40	40	Passing Through or Around Barrier
41	41	Failure to Observe Warnings or Instructions on Vehicle Displaying Them
42	42	Failure to Signal Intentions
43	43	Driving too Fast for Conditions (<i>2008 Only</i>)
44	--	Driving too Fast for Conditions or in Excess of Posted Speed Limit (<i>1982-2007 Only</i>)
44	--	Driving in Excess of Posted Speed Limit (<i>2008 Only</i>)
45	45	Driving Less Than Posted Maximum
46	--	Operating at Erratic or Suddenly Changing Speeds (<i>1982-1994 Only</i>)
46	--	Not Used (<i>1995-1997 Only</i>)
46	--	Racing (<i>1998-2008 Only</i>)
47	47	Making Right Turn from Left-Turn Lane or Making Left Turn from Right-Turn Lane
48	48	Making Improper Turn
49	--	Failure to Comply With Physical Restrictions of License (<i>1982-2004 Only</i>)
50	50	Driving Wrong Way on One-Way Trafficway
51	51	Driving on Wrong Side of Road (<i>Intentionally or Unintentionally</i>)
52	52	Operator Inexperience
53	53	Unfamiliar With Roadway
54	54	Stopping in Roadway (<i>Vehicle Not Abandoned</i>)
55	--	Underriding a Parked Truck (<i>1982-2008 Only</i>)
56	--	Improper Tire Pressure (<i>1982-2005 Only</i>)
57	57	Locked Wheel
58	58	Over Correcting
59	59	Getting Off/Out of or On/In to Moving Vehicle
60	--	Getting Off/Out of or On/In to Non-Moving Vehicle (<i>1982-2004 Only</i>)
VISION OBSCURED BY		
61	--	Rain, Snow, Fog, Smoke, Sand, Dust (<i>1982-2008 Only</i>)
62	--	Reflected Glare, Bright Sunlight, Headlights (<i>1982-2008 Only</i>)
63	--	Curve, Hill, or Other Design Features (<i>Including Traffic Signs, Embankment 1982-2008 Only</i>)
64	--	Building, Billboard, etc. (<i>1982-2008 Only</i>)
65	--	Trees, Crops, Vegetation (<i>1982-2008 Only</i>)

D24 Related Factors- Driver Level (continued)**Attribute Codes**

1982- 2009	2010- Later	
-----------------------	------------------------	--

66	--	Motor Vehicle (<i>Including Load 1982-2008 Only</i>)
67	--	Parked Vehicle (<i>1982-2008 Only</i>)
68	--	Splash or Spray of Passing Vehicle (<i>1982-2008 Only</i>)
69	--	Inadequate Defrost or Defog System (<i>1982-2008 Only</i>)
70	--	Inadequate Vehicle Lighting System (<i>1982-2008 Only</i>)
71	--	Obstructing Angles on Vehicle (<i>1982-2008 Only</i>)
72	--	Mirrors- Rear View (<i>1982-2008 Only</i>)
73	--	Mirrors- Other (<i>1982-2001 Only</i>)
73	73	Driver Has Not Complied with Learners Permit or Intermediate Driver License Restrictions (<i>GDL Restrictions, Since 2004</i>)
74	--	Head Restraints (<i>1982-2001 Only</i>)
74	74	Driver Has Not Complied With Physical or Other Imposed Restrictions (<i>Since 2004</i>)
75	--	Broken or Improperly Cleaned Windshield (<i>1982-2008 Only</i>)
76	--	Other Obstruction (<i>1982-2008 Only</i>)

AVOIDING, SWERVING, OR SLIDING DUE TO

77	77	Severe Crosswind
78	78	Wind from Passing Truck
79	79	Slippery or Loose Surface
80	80	Tire Blow-Out or Flat
81	81	Debris or Objects in Road
82	82	Ruts, Holes, Bumps in Road
83	83	Live Animals in Road
84	84	Vehicle in Road
85	85	Phantom Vehicle
86	86	Pedestrian, Pedalcyclist, or Other Non-Motorist in Road
87	87	Ice, Water, Snow, Slush, Sand, Dirt, Oil, Wet Leaves on Road
88	88	Trailer Fishtailing or Swaying (<i>Since 2001</i>)

OTHER MISCELLANEOUS FACTORS

89	--	Carrying Hazardous Cargo Improperly (<i>1994-2009</i>)
--	89	Driver has a Driving Record or Driver's License from More than One State
90	--	Hit-and-Run Vehicle Driver
91	91	Non-Traffic Violation Charged - Manslaughter or Homicide or Other Assault (<i>Since 1986</i>)
92	92	Other Non-Moving Traffic Violation (<i>Since 1986</i>)

POSSIBLE DISTRACTIONS INSIDE VEHICLE

93	--	Cellular Telephone (<i>Since 1991</i>)
94	--	Fax Machine (<i>1991-2001</i>)
94	--	Cellular Telephone in Use in Vehicle (<i>Since 2002</i>)
95	--	Computer (<i>1991-2001</i>)
95	--	Computer Fax Machines/Printers (<i>Since 2002</i>)

D24 Related Factors- Driver Level (continued)

Attribute Codes

1982- 2009	2010- Later	
96	--	On-Board Navigation System (<i>Since 1991</i>)
97	--	Two-Way Radio (<i>Since 1991</i>)
98	--	Head-Up Display (<i>Since 1991</i>)
99	99	Unknown

More Information on [Police Pursuits](#)

PC5 Trafficway Description

Definition: This element identifies the attribute that best describes the trafficway flow just prior to this vehicle's critical precrash event, based on the case materials.

Additional Information: This variable also appears in the Accident data set as DTRAFWAY.

SAS Name: VTRAFWAY

Attribute Codes**2010-Later**

- 0 Non-Trafficway Area
- 1 Two-Way, Not Divided
- 5 Two-Way, Not Divided With a Continuous Left-Turn Lane
- 2 Two-Way, Divided, Unprotected (*Painted > 4 Feet*) Median
- 3 Two-Way, Divided, Positive Median Barrier
- 4 One-Way Trafficway
- 6 Entrance/Exit Ramp
- 8 Not Reported
- 9 Unknown

PC6 Total Lanes in Roadway

Definition: This element identifies the attribute that best describes the number of travel lanes just prior to this vehicle's critical precrash event, based on the case materials.

Additional Information: The number of lanes refers to the number of lanes of a continuous cross-section of roadway. For example, a local roadway with one lane going north and one lane going south would be coded as two lanes. However, if a trafficway is a divided highway, with two lanes going north, a median, and two lanes going south, then the number of lanes is coded as two. If a trafficway has two lanes going north immediately adjacent to two lanes going south, one continuous cross-section of roadway, then the number of lanes is coded as four. This variable can be used with the trafficway flow variable TRAF_FLO to determine the trafficway geometry. For example: If (NO_LANES EQ 2) AND (TRAF_FLO EQ 1), then one has a two-lane roadway that is not physically divided, that is what most people think of as a two-lane road, one lane going in each direction.

In 2010, this variable was no longer collected at the Accident level. It is now collected at the Vehicle level.

SAS Name: **VNUM_LAN**

Attribute Codes**2010-Later**

- 0 Non-Trafficway Area
- 1 One Lane
- 2 Two Lanes
- 3 Three Lanes
- 4 Four Lanes
- 5 Five Lanes
- 6 Six Lanes
- 7 Seven or More Lanes
- 8 Not Reported
- 9 Unknown

PC7 Speed Limit

Definition: This element identifies the attribute that best represents the speed limit just prior to this vehicle's critical precrash event, based on the case materials.

Additional Information: : In 2010, this variable was no longer collected at the Accident level. It is now collected at the Vehicle level.

SAS Name: **VSPD_LIM**

Attribute Codes*2010-Later*

00	No Statutory Limit/Non-Trafficway Area
01-97	Speed Limit in Miles per Hour
98	Not Reported
99	Unknown

PC8 Roadway Alignment

Definition: This element identifies the attribute that best represents the roadway alignment prior to this vehicle's critical precrash event, based on the case materials.

Additional Information: : In 2010, this variable was no longer collected at the Accident level. It is now collected at the Vehicle level.

SAS Name: **VALIGN**

Attribute Codes***2010-Later***

- 0 Non-Trafficway Area
- 1 Straight
- 2 Curve Right
- 3 Curve Left
- 4 Curve - Unknown Direction
- 8 Not Reported
- 9 Unknown

PC9 Roadway Grade

Definition: This element identifies the attribute that best represents the roadway grade prior to this vehicle's critical precrash event, based on the case materials.

Additional Information: : In 2010, this variable was no longer collected at the Accident level. It is now collected at the Vehicle level.

SAS Name: **VPROFILE**

Attribute Codes**2010-Later**

- 0 Non-Trafficway Area
- 1 Level
- 2 Grade, Unknown Slope
- 3 Hillcrest
- 4 Sag (*Bottom*)
- 5 Uphill
- 6 Downhill
- 8 Not Reported
- 9 Unknown

PC10 Roadway Surface Type

Definition: This element identifies the attribute that best represents the roadway surface type prior to this vehicle's critical precrash event, based on the case materials.

Additional Information: : In 2010, this variable was no longer collected at the Accident level. It is now collected at the Vehicle level.

SAS Name: **VPAVETYP**

Attribute Codes**2010-Later**

- 0 Non-Trafficway Area
- 1 Concrete
- 2 Blacktop, Bituminous, or Asphalt
- 3 Brick or Block
- 4 Slag, Gravel or Stone
- 5 Dirt
- 7 Other
- 8 Not Reported
- 9 Unknown

PC11 Roadway Surface Condition

Definition: This element identifies the attribute that best represents the roadway surface condition prior to this vehicle's critical precrash event, based on the case materials.

Additional Information: : In 2010, this variable was no longer collected at the Accident level. It is now collected at the Vehicle level.

SAS Name: **VSURCOND**

Attribute Codes**2010-Later**

00	Non-Trafficway Area
01	Dry
02	Wet
03	Snow
04	Ice/Frost
05	Sand
06	Water (<i>Standing or Moving</i>)
07	Oil
08	Other
10	Slush
11	Mud, Dirt, Gravel
98	Not Reported
99	Unknown

PC12 Traffic Control Device

Definition: This element identifies the attribute that best describes the traffic controls in the vehicle's environment just prior to this vehicle's critical precrash event, based on the case materials.

Additional Information: : In 2010, this variable was no longer collected at the Accident level. It is now collected at the Vehicle level.

SAS Name: **VTRAFCON**

Attribute Codes**2010-Later**

00 No Controls

TRAFFIC SIGNALS

01 Traffic Control Signal (*On Colors*) Without Pedestrian Signal

02 Traffic Control (*On Colors*) With Pedestrian Signal

03 Traffic Control Signal (*On Colors*) Not Known if Pedestrian Signal

04 Flashing Traffic Control Signal

08 Other Highway Traffic Signal

09 Unknown Highway Traffic Signal

REGULATORY SIGNS

07 Lane Use Control Signal

20 Stop Sign

21 Yield Sign

28 Other Regulatory Sign

29 Unknown Regulatory Sign

32 School Zone Sign/Device

40 Warning Sign

50 Person

65 Railway Crossing Device

97 Not Reported

98 Other

99 Unknown

PC13 Traffic Control Device Functioning

Definition: This element identifies the functionality of the traffic control device recorded for this vehicle in the element Traffic Control Device.

Additional Information: Data not collected prior to 1982.

In 2010, this variable was no longer collected at the Accident level. It is now collected at the Vehicle level.

SAS Name: VTCONT_F

Attribute Codes*2010-Later*

- 0 No Controls
- 1 Device Not Functioning
- 2 Device Functioning - Functioning Improperly
- 3 Device Functioning Properly
- 8 Not Reported
- 9 Unknown

PC14 Driver's Vision Obscured by

Definition: This element records impediments to a driver's visual field that were noted in the case materials.

Additional Information: Most of these elements can be found in "Related Factor – Driver Level" from 1982 to 2008. This variable was added here in 2009. In 2010, the variable was changed to identify all that apply in the crash and was therefore moved to its own data set, Vision.

SAS Name: **D_VISION1, D_VISION2, D_VISION3**

Attribute Codes**2009**

- 00 No Obstruction Noted
- 01 Rain, Snow, Fog, Smoke, Sand, Dust
- 02 Reflected Glare, Bright Sunlight, Headlights
- 03 Curve, Hill, or Other Roadway Design Features
- 04 Building, Billboard, or Other Structure
- 05 Trees, Crops, Vegetation
- 06 In-Transport Motor Vehicle (*including load*)
- 07 Not-in-Transport Motor Vehicle (parked, working)
- 08 Splash or Spray of Passing Vehicle
- 09 Inadequate Defrost or Defog System
- 10 Inadequate Vehicle Lighting System
- 11 Obstructing Interior to the Vehicle
- 12 External Mirrors
- 13 Broken or Improperly Cleaned Windshield
- 14 Obstructing Angles on Vehicle
- 97 Vision Obscured – No Details
- 98 Other Visual Obstruction
- 99 Unknown

PC17 Pre-Event Movement (Prior To Recognition of Critical Event)

Definition: This element identifies the attribute that best describes this vehicle's activity prior to the driver's realization of an impending critical event or just prior to impact if the driver took no action or had no time to attempt any evasive maneuvers.

Additional Information:

SAS Name: **P_CRASH1**

Attribute Codes**2010-Later**

- 00 No Driver Present
- 01 Going Straight
- 02 Decelerating in Traffic Lane
- 03 Accelerating in Traffic Lane
- 04 Starting in Traffic Lane
- 05 Stopped in Traffic Lane
- 06 Passing or Overtaking Another Vehicle
- 07 Disabled or Parked in Travel Lane
- 08 Leaving a Parking Position
- 09 Entering a Parking Position
- 10 Turning Right
- 11 Turning Left
- 12 Making a U-Turn
- 13 Backing Up (*Other Than For Parking Position*)
- 14 Negotiating a Curve
- 15 Changing Lanes
- 16 Merging
- 17 Successful Avoidance Maneuver to a Previous Critical Event
- 98 Other
- 99 Unknown

PC19 Critical Event- Pre-Crash (Event)

Definition: This element identifies the critical event which made the crash imminent.

Additional Information:

SAS Name: P_CRASH2

Attribute Codes

2010-Later

THIS VEHICLE LOSS OF CONTROL DUE TO:

- 01 Blow Out/Flat Tire
- 02 Stalled Engine
- 03 Disabling Vehicle Failure (*e.g., Wheel Fell Off*)
- 04 Non-Disabling Vehicle Problem (*e.g., Hood Flew Up*)
- 05 Poor Road Conditions (*Puddle, Pothole, Ice, etc.*)
- 06 Traveling Too Fast For Conditions
- 08 Other Cause of Control Loss
- 09 Unknown Cause of Control Loss

THIS VEHICLE TRAVELING

- 10 Over the Lane Line on Left Side of Travel Lane
- 11 Over the Lane Line on Right Side of Travel Lane
- 12 Off the Edge of the Road on the Left Side
- 13 Off the Edge of the Road on the Right Side
- 14 End Departure
- 15 Turning Left at Intersection
- 16 Turning Right at Intersection
- 17 Crossing Over (*Passing Through*) Intersection
- 18 This Vehicle Decelerating
- 19 Unknown Travel Direction

OTHER MOTOR VEHICLE IN LANE

- 50 Other Vehicle Stopped
- 51 Traveling In Same Direction with Lower or Steady Speed
- 52 Traveling In Same Direction while Decelerating
- 53 Traveling In Same Direction with Higher Speed
- 54 Traveling In Opposite Direction
- 55 In Crossover
- 56 Backing
- 59 Unknown Travel Direction of the Other Motor Vehicle in Lane

OTHER MOTOR VEHICLE ENCROACHING INTO LANE

- 60 From Adjacent Lane (*Same Direction*) Over Left Lane Line
- 61 From Adjacent Lane (*Same Direction*) Over Right Lane Line
- 62 From Opposite Direction Over Left Lane Line
- 63 From Opposite Direction Over Right Lane Line
- 64 From Parking Lane, Median, Shoulder, Roadside

PC19 Critical Event- Pre-Crash (Event) (continued)

Attribute Codes**2010-Later**

- 65 From Crossing Street, Turning Into Same Direction
- 66 From Crossing Street, Across Path
- 67 From Crossing Street, Turning Into Opposite Direction
- 68 From Crossing Street, Intended Path Not Known
- 70 From Driveway, Turning Into Same Direction
- 71 From Driveway, Across Path
- 72 From Driveway, Turning Into Opposite Direction
- 73 From Driveway, Intended Path Not Known
- 74 From Entrance to Limited Access Highway
- 78 Encroachment by Other Vehicle - Details Unknown

PEDESTRIAN OR PEDALCYCLIST OR OTHER NON-MOTORIST

- 80 Pedestrian in Roadway
- 81 Pedestrian Approaching Roadway
- 82 Pedestrian Unknown Location
- 83 Pedalcyclist or Other Non-Motorist in Roadway
- 84 Pedalcyclist or Other Non-Motorist Approaching Roadway
- 85 Pedalcyclist or Other Non-Motorist Unknown Location

OBJECT OR ANIMAL

- 87 Animal in Roadway
- 88 Animal Approaching Roadway
- 89 Animal - Unknown Location
- 90 Object in Roadway
- 91 Object Approaching Roadway
- 92 Object Unknown Location

OTHER

- 98 Other Critical Precrash Event
- 99 Unknown

PC20 Attempted Avoidance Maneuver

Definition: This element identifies movements/actions taken by the driver, within a critical crash envelope, in response to a Critical Precrash Event.

Additional Information:

SAS Name: P_CRASH3

Attribute Codes**2010-Later**

- 00 No Driver Present
- 01 No Avoidance Maneuver
- 02 Braking (*No Lockup*)
- 03 Braking (*Lockup*)
- 04 Braking (*Lockup Unknown*)
- 05 Releasing Brakes
- 06 Steering Left
- 07 Steering Right
- 08 Braking and Steering Left
- 09 Braking and Steering Right
- 10 Accelerating
- 11 Accelerating and Steering Left
- 12 Accelerating and Steering Right
- 98 Other Actions
- 99 Unknown

Crash Avoidance Maneuver (discontinued)

Definition: This element is collected to indicate if an avoidance maneuver was taken by the driver to avoid the crash.

Additional Information: AVOID is the maneuver that the driver executed to attempt to avoid the crash. See VEH_MAN, Vehicle Maneuver, for the maneuver the driver was executing just prior to entering a crash situation.

This variable was discontinued after 2009.

SAS Name: AVOID

Attribute Codes**1991-2009**

- 0 No Avoidance Maneuver Reported
- 1 Braking (*Skid Marks Evident*)
- 2 Braking (*No Skid Marks; Driver Stated*)
- 3 Braking (*Other Reported Evidence*)
- 4 Steering (*Evidence or Stated*)
- 5 Steering and Braking (*Evidence or Stated*)
- 6 Other Avoidance Maneuver
- 8 Not Reported / (*Inconclusive Since 1999, By Police*)

PC21 Pre-Impact Stability

Definition: This element assesses the stability of the vehicle after the critical event, but before the impact.

Additional Information:

SAS Name: PCRASH4

Attribute Codes***2010-Later***

- 0 No Driver Present
- 1 Tracking
- 2 Skidding Longitudinally Rotation Less Than 30 Degrees
- 3 Skidding Laterally Clockwise Rotation
- 4 Skidding Laterally Counterclockwise Rotation
- 7 Other Vehicle Loss-Of-Control
- 9 Precrash Stability Unknown

PC22 Pre-Impact Location

Definition: This element assesses the location of the vehicle after the critical event, but before the impact.

Additional Information:

SAS Name: **PCRASH5**

Attribute Codes***2010-Later***

- 0 No Driver Present
- 1 Stayed In Original Travel Lane
- 2 Stayed On Roadway, But Left Original Travel Lane
- 3 Stayed On Roadway, Not Known if Left Original Travel Lane
- 4 Departed Roadway
- 5 Remained Off Roadway
- 6 Returned to Roadway
- 7 Entered Roadway
- 9 Unknown

PC23 Crash Type

Definition: This element describes the type of crash this in-transport vehicle was involved in based on the First Harmful Event and the Pre-crash circumstances.

Additional Information:

SAS Name: ACC_TYPE

Attribute Codes*2010-Later*

0 No Impact

CATEGORY I: SINGLE DRIVER*CONFIGURATION A: RIGHT ROADSIDE DEPARTURE*

- 1 Drive Off Road
- 2 Control/Traction Loss
- 3 Avoid Collision with Vehicle, Pedestrian, Animal
- 4 Specifics Other
- 5 Specifics Unknown

CONFIGURATION B: LEFT ROADSIDE DEPARTURE

- 6 Drive Off Road
- 7 Control/Traction Loss
- 8 Avoid Collision With Vehicle, Pedestrian, Animal
- 9 Specifics Other
- 10 Specifics Unknown

CONFIGURATION C: FORWARD IMPACT

- 11 Parked Vehicle
- 12 Stationary Object
- 13 Pedestrian/Animal
- 14 End Departure
- 15 Specifics Other
- 16 Specifics Unknown

CATEGORY II: SAME TRAFFICWAY, SAME DIRECTION*CONFIGURATION D: REAR END*

- 20 Stopped
- 21 Stopped, Straight
- 22 Stopped, Left
- 23 Stopped, Right
- 24 Slower
- 25 Slower, Going Straight
- 26 Slower, Going Left
- 27 Slower, Going Right
- 28 Decelerating (*Slowing*)
- 29 Decelerating (*Slowing*), Going Straight

PC23 Crash Type (continued)

Attribute Codes**2010-Later**

- 30 Decelerating (*Slowing*), Going Left
- 31 Decelerating (*Slowing*), Going Right
- 32 Specifics Other
- 33 Specifics Unknown

CONFIGURATION E: FORWARD IMPACT

- 34 This Vehicles Frontal Area Impacts Another Vehicle.
- 35 This Vehicle Is Impacted by Frontal Area of Another Vehicle
- 36 This Vehicles Frontal Area Impacts Another Vehicle.
- 37 This Vehicle Is Impacted by Frontal Area of Another Vehicle
- 38 This Vehicles Frontal Area Impacts Another Vehicle.
- 39 This Vehicle Is Impacted by Frontal Area of Another Vehicle
- 40 This Vehicles Frontal Area Impacts Another Vehicle.
- 41 This Vehicle Is Impacted by Frontal Area of Another Vehicle
- 42 Specifics Other
- 43 Specifics Unknown

CONFIGURATION F: SIDESWIPE/ANGLE

- 44 Straight Ahead on Left.
- 45 Straight Ahead on Left/Right.
- 46 Changing Lanes to the Right
- 47 Changing Lanes to the Left
- 48 Specifics Other
- 49 Specifics Unknown

CATEGORY III: SAME TRAFFICWAY, OPPOSITE DIRECTION**CONFIGURATION G: HEAD-ON**

- 50 Lateral Move (*Left/Right*)
- 51 Lateral Move (*Going Straight*)
- 52 Specifics Other
- 53 Specifics Unknown

CONFIGURATION H: FORWARD IMPACT

- 54 This Vehicles Frontal Area Impacts Another Vehicle.
- 55 This Vehicle Is Impacted by Frontal Area of Another Vehicle
- 56 This Vehicles Frontal Area Impacts Another Vehicle.
- 57 This Vehicle Is Impacted by Frontal Area of Another Vehicle
- 58 This Vehicles Frontal Area Impacts Another Vehicle.
- 59 This Vehicle Is Impacted by Frontal Area of Another Vehicle
- 60 This Vehicles Frontal Area Impacts Another Vehicle.
- 61 This Vehicle Is Impacted by Frontal Area of Another Vehicle
- 62 Specifics Other
- 63 Specifics Unknown

PC23 Crash Type (continued)

Attribute Codes**2010-Later***CONFIGURATION I: SIDESWIPE/ANGLE*

- 64 Lateral Move (*Left/Right*)
- 65 Lateral Move (*Going Straight*)
- 66 Specifics Other
- 67 Specifics Unknown

CATEGORY IV: CHANGING TRAFFICWAY, VEHICLE TURNING*CONFIGURATION J: TURN ACROSS PATH*

- 68 Initial Opposite Directions (*Left/Right*)
- 69 Initial Opposite Directions (*Going Straight*)
- 70 Initial Same Directions (*Turning Right*)
- 71 Initial Same Directions (*Going Straight*)
- 72 Initial Same Directions (*Turning Left*)
- 73 Initial Same Directions (*Going Straight*)
- 74 Specifics Other
- 75 Specifics Unknown

CONFIGURATION K: TURN INTO PATH

- 76 Turn Into Same Direction (*Turning Left*)
- 77 Turn Into Same Direction (*Going Straight*)
- 78 Turn Into Same Direction (*Turning Right*)
- 79 Turn Into Same Direction (*Going Straight*)
- 80 Turn Into Opposite Directions (*Turning Right*)
- 81 Turn Into Opposite Directions (*Going Straight*)
- 82 Turn Into Opposite Directions (*Turning Left*)
- 83 Turn Into Opposite Directions (*Going Straight*)
- 84 Specifics Other
- 85 Specifics Unknown

CATEGORY V: INTERSECTING PATHS (VEHICLE DAMAGE)*CONFIGURATION L: STRAIGHT PATHS*

- 86 Striking from the Right
- 87 Struck on the Right
- 88 Striking from the Left
- 89 Struck on the Left
- 90 Specifics Other
- 91 Specifics Unknown

CATEGORY VI: MISCELLANEOUS*CONFIGURATION M: BACKING, ETC.*

- 92 Backing Vehicle
- 93 Other Vehicle or Object
- 97 Untripped Rollover (*1992 to 1998 only*)
- 98 Other Accident Type
- 99 Unknown Accident Type

Vehicle Maneuver (discontinued)

Definition: This element captures the driver's action, or intended action, prior to the commencement of the unstabilized event as indicated on the crash report.

Additional Information: This variable was discontinued after 2009.

VEH_MAN is the maneuver that the driver was executing just prior to entering a crash situation. For the maneuver that the driver executed to attempt to avoid the crash, see the variable AVOID under Crash Avoidance Maneuver.

SAS Name: VEH_MAN

Attribute Codes**1982-2009**

- 01 Going Straight
- 02 Slowing or Stopping in Traffic Lane
- 03 Starting in Traffic Lane
- 04 Stopped in Traffic Lane
- 05 Passing or Overtaking another Vehicle
- 06 Leaving a Parked Position
- 07 Parked
- 08 Entering a Parked Position
- 09 Maneuvering to Avoid
- 10 Turning Right: Right Turn on Red Permitted
- 11 Turning Right: Right Turn on Red Not Permitted
- 12 Turning Right: Right Turn on Red Not Applicable or Not Known if Permitted
- 13 Turning Left
- 14 Making a U-Turn
- 15 Backing Up (*Not Parking*)
- 16 Changing Lanes or Merging
- 17 Negotiating a Curve
- 98 Other
- 99 Unknown

Vehicle Role (discontinued)

Definition: This element Indicates the vehicle's role in single or multi-vehicle crashes.

Additional Information: This variable was discontinued after 2009.

Note when a vehicle is both striking and struck, i.e., Value = 3, the event cannot simultaneously be at the same point of the vehicle. A vehicle must have at least one striking impact point and a struck impact point. A classic example is a chain reaction rear-end crash, where a vehicle which is both striking and struck is located within the chain.

SAS Name: **IMPACTS**

Attribute Codes**1975-2009**

0	Non-Collision
1	Striking
2	Struck
3	Both
9	Unknown

Axles (discontinued)

Definition: This element counts the total number of axles on the vehicle (and converter dolly), including the trailing units (includes raised axles).

Additional Information: From 1991 to 1994, this variable counts the total number of deployed axles on the *ground* for the vehicle including trailing units. From 1995 to 2007, this variable counts the total number of axles on the *vehicle* for the vehicle including trailing units.

The major change in this variable from 1994 to 1995 is the count of axles on the vehicle rather than the deployed axles on the ground. From 1991 to 1994, this variable counts the total number of deployed axles on the *ground* for the vehicle including trailing units. From 1995 to 2007, this variable counts the total number of axles on the *vehicle* for the vehicle including trailing units.

This variable was discontinued after 2007.

SAS Name: AXLES

Attribute Codes

1991- 1994	1995- 2007	
00	00	Not Applicable, Not a Medium/Heavy Truck or Bus
02-97	02-97	Number of Axles
98	98	Medium/Heavy Truck or Bus, Number of Axles Unknown
99	--	Unknown Vehicle Type
--	99	Unknown if Light or Medium/Heavy Truck or Bus

Driver Training (discontinued)

Definition: This variable was discontinued after 1986.

Additional Information:

SAS Name: DR_TRAIN

Attribute Codes

1975-1986

- 0 None
- 1 High School
- 2 Commercial
- 3 School Bus
- 4 Traffic School
- 5 Two or More Types
- 6 Training, Type Unknown (*Since 1977*)
- 9 Unknown

The PERSON Data Set

The Person data set includes Motorist as well as Non-Motorist data. It contains the variables ST_CASE, VEH_NO, and PER_NO, which are the case identifiers. The data set also contains:

P5/NM5 Age

Definition: This element identifies the person's age, in years, with respect to the person's last birthday.

Additional Information:

SAS Name: AGE

Attribute Codes**1975-2008**

00	Up to One Year
01-96	Age of the Individual in Years
97	97 Years Old or Older
99	Unknown

2010-

2009	Later	
000	000	Less than One Year
001-120	001-120	Age of the Individual in Years
--	998	Not Reported
999	999	Unknown

P6/NM6 Sex

Definition: This element identifies the sex of the person involved in the crash

Additional Information: From 1975 to 1981, if no information was known about the hit-and-run vehicle and/or driver, then neither the vehicle form nor the driver form were filled out and were not counted in the FARS census. Starting in 1982 both a vehicle and a driver form were filled out and the data were identified as unknown. This is why there were approximately only 20 to 40 drivers with unknown sex listed in the FARS data set from 1975 to 1981 and 700 to 1000 drivers with unknown sex from 1982 on.

On March 22, 1995, a quick review of the 1994 Annual Report File revealed that of the 768 persons in the 1994 file with unknown sex; over 90 percent were involved in hit-and-run crashes.

SAS Name: **SEX**

Attribute Codes

1975- 2009	2010- Later	
1	1	Male
2	2	Female
--	8	Not Reported
9	9	Unknown

P7/NM7 Person Type

Definition: This element describes the role of this person involved in the crash.

Additional Information:

SAS Name: PER_TYP

Attribute Codes**1975-1981**

- 1 Driver
- 2 Passenger
- 3 Non-Motorist: Pedestrian
- 4 Non-Motorist: Pedalcyclist
- 5 Non-Motorist: Occupant of Non-Traffic-Unit Vehicle
- 8 Non-Motorist: Other or Unknown
- 9 Occupant: Unknown Type

1982-1993

- 1 Driver of a Motor Vehicle in Transport
- 2 Passenger of a Motor Vehicle in Transport
- 3 Occupant of a Motor Vehicle Not in Transport
- 4 Occupant of a Non-Motor Vehicle Transport Device (*e.g., Horse and Buggy*)
- 5 Non-Occupant Pedestrian
- 6 Non-Occupant Bicyclist
- 7 Non-Occupant Other Cyclist
- 8 Non-Occupant Other or Unknown
- 9 Unknown Occupant Type in a Motor Vehicle in Transport

1994-2009

- 01 Driver
- 02 Passenger of a Motor Vehicle in Transport
- 03 Occupant of a Motor Vehicle Not in Transport
- 04 Occupant of a Non-Motor Vehicle Transport Device
- 05 Pedestrian
- 06 Bicyclist
- 07 Other Cyclist
- 08 Persons on Personal Conveyances (*Since 2007*)
- 08 Other Pedestrian (*Includes Persons on Personal Conveyances, 1994-2006*)
- 09 Unknown Occupant Type in a Motor Vehicle in Transport
- 10 Persons In/On Buildings (*Since 2007*)
- 19 Unknown Type of Non-Motorist
- 99 Unknown

P7/NM7 Person Type (continued)

Attribute Codes**2010-Later**

- 01 Driver of a Motor Vehicle In-Transport
- 02 Passenger of a Motor Vehicle In-Transport
- 03 Occupant of a Motor Vehicle Not In-Transport
- 04 Occupant of a Non-Motor Vehicle Transport Device
- 05 Pedestrian
- 06 Bicyclist
- 07 Other Bicyclist
- 08 Person on Personal Conveyances
- 09 Unknown Occupant Type in a Motor Vehicle In-Transport
- 10 Persons In/On Buildings
- 19 Unknown
- 88 Not Reported

More Information on [Person Type](#)

P8/NM8 Injury Severity

Definition: This element describes the severity of the injury to this person in the crash.

Additional Information: It is important to realize that some States some time do not collect data on persons who were in a crash but were not injured. If the analysis being performed depends on non-injured occupants -- for example some paired comparisons -- check the data at the State level.

This variable was new for non-motorists in 2010.

SAS Name: **INJ_SEV**

Attribute Codes

<i>1975- 2009</i>	<i>2010 Later</i>	
0	0	No Injury (<i>O</i>)
1	1	Possible Injury (<i>C</i>)
2	2	Non-Incapacitating Evident Injury (<i>B</i>)
3	3	Incapacitating Injury (<i>A</i>)
4	4	Fatal Injury (<i>K</i>)
5	5	Injured, Severity Unknown (<i>Since 1978</i>)
6	6	Died Prior to Crash
--	8	Not Reported
9	9	Unknown

P9 Seating Position

Definition: This element identifies the location of this person in or on the vehicle.

Additional Information:

SAS Name: SEAT_POS

Attribute Codes**1975-1981**

00	Non-Motorist
01	Front Seat - Left Side (<i>Driver's Side</i>)
02	Front Seat - Middle
03	Front Seat - Right Side
04	Second Seat - Left Side (<i>Driver's Side</i>)
05	Second Seat - Middle
06	Second Seat - Right Side
07	Third Seat - Left Side (<i>Driver's Side</i>)
08	Third Seat - Middle
09	Third Seat - Right Side
10	Front Seat - Other
11	Second Seat - Other
12	Third Seat - Other
13	Other Passenger
14	Cab Sleeper
15	Vehicle Exterior
99	Unknown

**1982- 2010-
2009 Later**

00	--	Non-Motorist (<i>1982-2004</i>)
00	00	Not a Motor Vehicle Occupant (<i>2005-Later</i>)
11	11	Front Seat - Left Side (<i>Driver's Side</i>)
12	12	Front Seat - Middle
13	13	Front Seat - Right Side
18	18	Front Seat - Other
19	19	Front Seat - Unknown
21	21	Second Seat - Left Side (<i>Driver's Side</i>)
22	22	Second Seat - Middle
23	23	Second Seat - Right Side
28	28	Second Seat - Other
29	29	Second Seat - Unknown
31	31	Third Seat - Left Side (<i>Driver's Side</i>)
32	32	Third Seat - Middle
33	33	Third Seat - Right Side
38	38	Third Seat - Other
39	39	Third Seat - Unknown

P9 Seating Position (continued)

Attribute Codes

1982- 2009	2010- Later	
41	41	Fourth Seat - Left Side (<i>Driver's Side</i>)
42	42	Fourth Seat - Middle
43	43	Fourth Seat - Right Side
48	48	Fourth Seat - Other
49	49	Fourth Seat - Unknown
50	50	Sleeper Section of Cab (<i>Truck</i>)
51	--	Other Passenger In Enclosed Passenger or Cargo Area [Includes Passengers In 5 th Row Of 15-Seat, 5-Row Vans] [Includes Injured Full-Size-Bus Occupants] (<i>2002-2008 Only</i>)
51	51	Other Passenger in Enclosed Passenger or Cargo Area (<i>Since 2009</i>)
52	52	Other Passenger in Unenclosed Passenger or Cargo Area
53	53	Other Passenger in Passenger or Cargo Area, Unknown Whether Or Not Enclosed
54	54	Trailing Unit
55	55	Riding on Vehicle Exterior
--	98	Not Reported
99	99	Unknown

More Information on [Seat Position](#)

P10 Restraint System/Helmet Use

Definition: This element records the restraint equipment in use by the occupant, or the helmet in use by a motorcyclist, at the time of the crash.

Additional Information: Bicycle helmets are sometimes worn while riding a variety of personal conveyances.

SAS Name: REST_USE

Attribute Codes**1991-1993**

- 0 None Used - Vehicle Occupant/Not Applicable-Non-Motorist
- 1 Shoulder Belt
- 2 Lap Belt
- 3 Lap and Shoulder Belt
- 4 Child Safety Seat
- 5 Motorcycle Helmet
- 8 Restraint Used - Type Unknown or Other Including Other Helmet
- 9 Unknown

**1994-2009 2010-
2009 Later**

- 00 -- None Used- Vehicle Occupant; Not Applicable (1994-2004)
- 00 -- None Used/Not Applicable - Not a Motor Vehicle Occupant (Since 2005)
- 00 Not Applicable
- 01 01 Shoulder Belt Only Used
- 02 02 Lap Belt Only Used
- 03 03 Lap and Shoulder Belt Used
- 04 -- Child Safety Seat (1994-2007)
- 04 -- Child Safety Seat/Booster Seat - Type Unknown/Not Reported (Since 2008)
- 04 Child Restraint Type Unknown
- 05 -- Motorcycle Helmet
- 05 DOT-Compliant Motorcycle Helmet
- 06 -- Bicycle Helmet
- 07 None Used – Motor Vehicle Occupant
- 08 08 Restraint Used - Type Unknown
- 10 10 Child Restraint System - Forward Facing (Since 2008)
- 11 11 Child Restraint System - Rear Facing (Since 2008)
- 12 -- Booster Seat with Lap/Shoulder Belt Used Properly (Since 2008)
- 12 Booster Seat
- 13 -- Safety Belt Used Improperly
- 14 -- Child Safety Seat Used Improperly (1994-2007)
- 14 -- Child Safety Seat/Booster Seat Used Improperly (2008-2009)
- 15 -- Helmets Used Improperly
- 16 Other Helmet
- 17 No Helmet

P10 Restraint System/Helmet Use (continued)

1994- 2009	2010- Later	
--	97	Other
--	98	Not Reported
99	99	Unknown

More Information on [Restraint Use](#)

P11 Indication of Misuse of Restraint System/Helmet

Definition: This element indicates any misuse of the restraint system or helmet used by this person.

Additional Information:

SAS Name: REST_MIS

Attribute Codes

2010-Later

0	No
1	Yes

P12 Air Bag Deployed

Definition: This element is used to record air bag availability and deployment for this person as reported in the case materials.

Additional Information:

SAS Name: AIR_BAG

Attribute Codes**1991-1997**

- 0 Non-Motorist
- 3 Deployed Air Bag
- 4 Non-Deployed Air Bag
- 9 Unknown or Not Applicable

1998-2008

00 Non-Motorist (*Not a Motor Vehicle Occupant, Since 2005*)

DEPLOYED (FOR THIS SEAT)

- 01 From Front (*Steering Wheel, Dashboard, Since 2007*)
- 01 Deployed Air Bag From Front (*1998-2006 Only*)
- 02 From Side (*Door, Seat, Canopy, Since 2007*)
- 02 Deployed Air Bag From Side (*1998-2006 Only*)
- 07 From Other Direction (*Knee, Airbelt, etc, Since 2007*)
- 07 Deployed Air Bag Other Direction (*1998-2006 Only*)
- 08 Deployed Air Bag Multiple Directions
- 09 Deployed Air Bag Direction Unknown

NOT DEPLOYED (FOR THIS SEAT)

- 20 Air Bag Available but Not Deployed for This Seat
- 28 Air Bag Available and Switched Off

UNKNOWN IF DEPLOYED

- 29 Air Bag Available, Deployment Not Known for This Seat

NOT AVAILABLE

- 30 Air Bag Not Available for This Seat
- 31 Air Bag Previously Deployed and Not Replaced
- 32 Air Bag Disabled or Removed
- 99 Unknown (*If Airbag Available*)

P12 Air Bag Deployed (continued)

Attribute Codes

	2010-	
2009	Later	
00	--	Not a Motor Vehicle Occupant
--	00	Not Applicable
01	01	Deployed: Front
02	02	Deployed: Side (<i>Door, Seatback</i>)
03	03	Deployed: Curtain (<i>Roof</i>)
07	07	Deployed: Other (<i>Knee, Air Belt, etc.</i>)
08	08	Deployed: Combination
09	09	Deployed: Unknown Location
20	20	Not Deployed
28	28	Switched Off
--	96	Not a Motor Vehicle Occupant
--	98	Not Reported
99	99	Deployment Unknown

P13 Ejection

Definition: This element describes the ejection status and degree of ejection for this person, excluding motorcycle occupants.

Additional Information: In the mid 1970's there were a large number of people coded as ejection unknown and a corresponding small number of people coded as not ejected. However, the totally ejected and partially ejected counts are the same magnitude as in later years.

SAS Name: **EJECTION**

Attribute Codes**1975-2006**

0	Not Ejected or Not Applicable
1	Totally Ejected
2	Partially Ejected
9	Unknown

**2007-2009 2010-
2009 Later**

0	0	Not Ejected
1	1	Totally Ejected
2	2	Partially Ejected
3	3	Ejected – Unknown Degree (<i>Since 2008</i>)
--	7	Not Reported
8	8	Not Applicable
9	--	Unknown (<i>2007-2008 Only</i>)
9	9	Unknown if Ejected (<i>Since 2009</i>)

More Information on [Ejection](#)

P14 Ejection Path

Definition: This element identifies the path by which this person was ejected from the vehicle.

Additional Information:

SAS Name: EJ_PATH

Attribute Codes

1991-Later

- 0 Not Ejected/Not Applicable
- 1 Through Side Door Opening (*All Side Doors*)
- 2 Through Side Window (*All Side Windows, Bus Side Windows*)
- 3 Through Windshield (*Front Windshield Only*)
- 4 Through Back Window (*Standard Rear Window, Back Window of Bronco, Van*)
- 5 Through Back Door/Tailgate (*Station Wagon Tailgate, Back Door of Truck, Back Door of Bronco, Van*)
- 6 Through Roof Opening (*Sun Roof, Convertible Top Down, T-Top, Targa Top*)
- 7 Through Roof (*Convertible Top Up*)
- 8 Other Path (*e.g., Back of Pickup Truck, Torn-Off Roof, Car Cut in Half*)
- 9 Unknown/Unknown Path

P15 Extrication

Definition: This element indicates whether equipment or other force was used to remove this person from the vehicle.

Additional Information: In Massachusetts, if an occupant is not injured, data for Protection system use and ejection are not coded on the police crash report.

From 1975 to 1976 the EXTRICAT and EJECTION variables were combined in a single field. The files were changed in 1977 to the current format. In 1975 and 1976 there are fewer persons identified as not extricated than in later years. Both the count of extricated persons and unknowns seem high for these years. From 1977 to 1981 there was not an edit check to prevent one coding an occupant as being both ejected and extricated. There are 69, 48, 83, 98, and 88 persons coded as both totally ejected and extricated in the 1977, 1978, 1979, 1980, and 1981 respectively.

SAS Name: **EXTRICAT**

Attribute Codes**1975-Later**

- 0 Not Extricated/Not Applicable
- 1 Extricated
- 9 Unknown

P16/NM15 Police Reported Alcohol Involvement

Definition: This element reflects only the judgment of law enforcement as to whether alcohol was involved or not for this person.

Additional Information: This variable was new for non-motorists in 2010.

SAS Name: DRINKING

Attribute Codes**1975-Later**

- 0 No (*Alcohol Not Involved*)
- 1 Yes (*Alcohol Involved*)
- 8 Not Reported
- 9 Unknown (*Police Reported*)

More Information on [Alcohol](#)

P17/NM16 Method of Alcohol Determination by Police

Definition: This element describes the method by which the police made the determination as to whether alcohol was involved or not for this person.

Additional Information: 1975 to 1979 data on the type of blood alcohol test were collected, but this data has since been removed from the analysis files.

This variable was new for non-motorists in 2010.

SAS Name: `ALC_DET`

Attribute Codes**1987-Later**

- 1 Evidential Test (*Breath, Blood, Urine*)
- 2 Preliminary Breath Test (*PBT*)
- 3 Behavioral
- 4 Passive Alcohol Sensor (*PAS*)
- 5 Observed
- 8 Other (*e.g., Saliva Test*)
- 9 Not Reported

P18/NM17 Alcohol Test

P18A/NM17A Alcohol Test Status

Definition: This element indicates whether an alcohol test was given to this person.

Additional Information: This variable was new for non-motorists in 2010.

SAS Name: **ALC_STATUS**

Attribute Codes

2009	2010- Later	
0	0	Test Not Given
1	1	Test Refused
2	2	Test Given
--	8	Not Reported
9	--	Unknown if Tested/Not Reported
--	9	Unknown if Tested

P18/NM17 Alcohol Test (continued)**P18B/NM17B Alcohol Test Type**

Definition: This element identifies the type of the alcohol test that was used for this person.

Additional Information: This variable was new for non-motorists in 2010.

SAS Name: ATST_TYP

Attribute Codes**1998-2003**

0	Not Tested for Alcohol
1	Whole Blood
2	Breath "BAC"
3	Urine
4	Vitreous
5	Blood Plasma/Serum
6	Blood Clot
7	Liver
8	Other Test Type
9	Unknown/Not Reported (<i>Since 2001</i>)

2004-2009 2010-Later

00	00	Not Tested for Alcohol
01	01	Blood Test
02	02	Breathalyzer "BAC"
03	03	Urine
04	04	Vitreous
05	05	Blood Plasma/Serum
06	06	Blood Clot
07	07	Liver
08	08	Other Test Type
09	--	Unknown/Not Reported
10	10	Preliminary Breath Test (<i>PBT</i>)
--	95	Not Reported
98	--	Positive Reading with No Actual Value (<i>2006-2008 Only</i>)
98	98	Unknown Test Type (<i>Since 2009</i>)
99	--	Unknown if Tested/Not Reported (<i>2009</i>)
--	99	Unknown if Tested

P18/NM17 Alcohol Test (continued)**P18C/NM17C Alcohol Test Result**

Definition: This element identifies the alcohol test result for this person.

Additional Information: A value of 10 is a BAC of .10. The decimal is implied before first digit. The BAC is expressed in grams per deciliter or a clinical evaluation of the same.

This variable was new for non-motorists in 2010.

SAS Name: **TEST_RES** 1975-1990
ALC_RES 1991-Later

Attribute Codes**1975-1990**

00-94	Actual Value of BAC Test
95	Test Refused
96	None Given
97	AC Test Performed, Results Unknown
99	Unknown

1991-2009 2010-Later

00-93	00-93	Actual Value of BAC Test
94	94	.94 or Greater (<i>The Value 94 Should be Interpreted as .94 or Greater</i>)
95	--	Test Refused (<i>1991-2008 Only</i>)
--	95	Not Reported
96	96	None Given
97	97	AC Test Performed, Results Unknown
98	98	PBT Positive Reading with No Actual Value (<i>Since 2004</i>)
99	--	Unknown if Tested/Not Reported
--	99	Unknown if Tested

P19/NM18 Police Reported Drug Involvement

Definition: This element reflects only the judgment of law enforcement as to whether drugs were involved or not for this person.

Additional Information: This variable was new for non-motorists in 2010.

SAS Name: DRUGS

Attribute Codes**1991-Later**

- 0 No (*Drug Not Involved*)
- 1 Yes (*Drug Involved*)
- 8 Not Reported
- 9 Unknown (*Police Reported*)

P20/NM19 Method of Drug Determination by Police

Definition: This element identifies the method by which the police made the determination as to whether drugs were involved or not for this person.

Additional Information: This variable was new for non-motorists in 2010.

SAS Name: **TOXCLGY** 1987-1990
DRUG_DET 1991-Later

Attribute Codes**1987-1990**

0 No Blood Test Given

BLOOD TEST GIVEN, RESULTS KNOWN

1 No Drugs Reported

2 Drugs Reported (*Excluding Nicotine, Aspirin*)

3 Not tested for Drugs

BLOOD TEST GIVEN, RESULTS UNKNOWN

7 Test for Drugs, Results, Unknown

8 Unknown if Tested for Drugs

9 Unknown if Drug Test Given

1991-Later

1 Evidential Test (*Blood, Urine*)

2 Drug Recognition Technician (*DRT*) Determination

3 Behavioral

7 Other

8 Not Reported

P21/NM20 Drug Test

P21A/NM20A Drug Test Status

Definition: This element indicates whether a drug test was given to this person.

Additional Information: This variable was new for non-motorists in 2010.

SAS Name: **DSTATUS**

Attribute Codes

	<i>2010- Later</i>	
<i>2009</i>	0	Test Not Given
	1	Test Refused
	2	Test Given
	--	Not Reported
	9	Unknown if Tested/Not Reported

P21/NM20 Drug Test (continued)

P21B/NM20B Drug Test Type

Definition: This element identifies the type of drug test that was used for this person.

Additional Information: This variable was new for non-motorists in 2010.

SAS Name: DRUGTEST 1991-1992
 DRUGTST1, DRUGTST2, DRUGTST3 1993-Later

Attribute Codes

1991-1992

- 0 Not Tested For Drugs
- 1 Blood Test
- 2 Urine Test
- 7 Unknown Test Type
- 8 Other Type Test
- 9 Unknown if Tested for Drugs

1993-2009 2010-Later

- 0 0 Test Not Given
- 1 1 Blood Test
- 2 2 Urine Test
- 3 3 Both: Blood and Urine Tests (Since 1993)
- 6 Not Reported
- 7 7 Unknown Test Type
- 8 8 Other Test Type
- 9 9 Unknown if Tested/Not Reported

P21/NM20 Drug Test (continued)

P21C/NM20C Drug Test Results

Definition: This element identifies the drug test result for this person.

Additional Information: The FARS analyst may have used any of the three variables to code a result of a drug test. One must test all three variables to insure that the selected result is included. *See Specific Drug Listing in the "FARS Coding and Validation Manual"

This variable was new for non-motorists in 2010.

SAS Name:	DRUG_RES	1991-1992
	DRUGRES1, DRUGRES2, DRUGRES3	1993-Later

Attribute Codes**1991-1992**

- 00 Not Tested for Drugs
- 01 No Drugs Reported
- 02 Narcotic
- 03 Depressant
- 04 Stimulant
- 05 Hallucinogen
- 06 Cannabinol
- 07 Phencyclidine (PCP)
- 08 Inhalant
- 09 Multiple Drugs (From Elements 02 to 08)
- 10 Other Drugs (All Other Drugs Excluding Nicotine, Aspirin, Alcohol)
- 97 Tested for Drugs, Results Unknown
- 98 Tested for Drugs, Drugs Found, Type Unknown
- 99 Unknown if Tested for Drugs

P21/NM20 Drug Test (continued)**P21C/NM20C Drug Test Results (continued)****Attribute Codes**

1993- 2009	2010- Later	
000	000	Not Tested for Drugs
001	001	No Drugs Reported/Negative
--	095	Not Reported
100-295	100-295	Narcotic*
300-395	300-395	Depressant*
400-495	400-495	Stimulant*
500-595	500-595	Hallucinogen*
600-695	600-695	Cannabinoid*
700-795	700-795	Phencyclidine (<i>PCP</i>) *
800-895	800-895	Anabolic Steroid*
900-995	900-995	Inhalant*
996	996	Other Drugs
997	997	Tested for Drugs, Results Unknown
998	998	Tested for Drugs, Drugs Found, Type Unknown/Positive
999	--	Unknown if Tested/Not Reported
--	999	Unknown if Tested

P22/NM21 Transported to Medical Facility By

Definition: This element identifies the method of transportation provided to this person to a hospital or medical facility.

Additional Information: This variable was new for non-motorists in 2010.

This field exists in the 1975 and 1976 file, but is not initialized, i.e., it has no values.

SAS Name: HOSPITAL

Attribute Codes**1977-2000**

- 0 No
- 1 Yes
- 7 Died at the Scene (1999-2000)
- 8 Died En Route (1999-2000)
- 9 Unknown

2001-2006

- 0 No
- 1 Yes
- 9 Unknown

2007-2009

- 0 Not Transported
- 1 Yes, EMS
- 2 Yes, Law Enforcement
- 3 Yes, Other
- 4 Yes, Transported by Unknown Source
- 9 Unknown

2010-Later

- 0 Not Transported
- 1 EMS Air
- 2 Law Enforcement
- 3 EMS Unknown Mode
- 4 Transported Unknown Source
- 5 EMS Ground
- 6 Other
- 8 Not Reported
- 9 Unknown

P23/NM22 **Died at Scene/En Route**

Definition: This element indicates whether this person died at the scene of the crash or en route to a hospital or treatment facility.

Additional Information:

SAS Name: DOA

Attribute Codes*2001-Later*

- 0 Not Applicable
- 7 Died at Scene
- 8 Died En Route
- 9 Unknown

P24/NM23 Death Date

P24A/NM23A Month of Death

Definition: This element records the month of this person's death.

Additional Information:

SAS Name: DEATH_MO

Attribute Codes

1975- 2007	2008- Later	
00	88	Not Applicable (<i>Non-Fatal</i>)
01	01	January
02	02	February
03	03	March
04	04	April
05	05	May
06	06	June
07	07	July
08	08	August
09	09	September
10	10	October
11	11	November
12	12	December
--	99	Unknown (<i>except 2009</i>)

P24B/NM23B Day of Death

Definition: This element records the day of the month of this person's death.

Additional Information:

SAS Name: DEATH_DA

Attribute Codes

1975- 2008	2009- Later	
00	88	Not Applicable (<i>Non-Fatal</i>)
01-31	01-31	Day of the Month of the Death
99	99	Unknown (<i>Since 2008</i>)

P24/NM23 Death Date (continued)

P24C/NM23C Year of Death

Definition: This element records the year of this person's death.

Additional Information: A person can die the year after the crash year.

SAS Name: DEATH_YR

Attribute Codes

1975- 1997	1998- 2008	2009- Later	
--	0000	8888	Not Applicable (<i>Non-Fatal</i>)
xx	xxxx	xxxx	Year of the Death

P25/NM24 **Death Time**

Definition: This element identifies the hour and minute of this person's death utilizing the 24-hour clock format.

Additional Information: four digits; DEATH_HR followed by DEATH_MN, e.g., Valid Military Times 0643 for 6:43 a.m.

SAS Name: **DEATH_TM**

Attribute Codes

1975- 2008-	2009 Later	
2400	0000	For Midnight
0001-2359	0001-2359	Time of Death in HHMM format
--	8888	Not Applicable (Non-Fatal)
9999	9999	Unknown

P25A/NM24A **Hour of Death**

Definition: This element identifies the hour of this person's death utilizing the 24-hour clock format.

Additional Information:

SAS Name: **DEATH_HR**

Attribute Codes

1975- 2008	2009	2010- Later	
00-24	00-23	00-23	Valid Military Times
--	88	--	Not Applicable
99	99	99	Unknown

P25B/NM24B **Minute of Death**

Definition: This element identifies the minute of this person's death.

Additional Information:

SAS Name: **DEATH_MN**

Attribute Codes

<i>1975- 2008</i>	<i>2009</i>	<i>2010- Later</i>	
00-59	00-59	00-59	Valid Military Times
--	88	--	Not Applicable
99	99	99	Unknown

P100 Lag Time

P100A Lag Hours

Definition: This element is derived as the hours between the time of the crash and the time of death.

Additional Information: Computed variable.

SAS Name: LAG_HRS

Attribute Codes

1975- 2008	2009	
00-24	00-23	Valid Military Times
--	88	Not Applicable
99	99	Unknown

P100B Lag Minutes

Definition: This element is derived as the minutes (in addition to hours) between the time of the crash and the time of death.

Additional Information: Computed variable.

SAS Name: LAG_MINS

Attribute Codes

1975- 2008	2009	
00-59	00-59	Valid Military Times
--	88	Not Applicable
99	99	Unknown

P26/NM25 Related Factors- Person Level

Definition: This element identifies factors related to motor vehicle occupants other than drivers and persons not in a motor vehicle expressed by the investigating officer.

Additional Information: There are also vehicle-level-related factors in the Vehicle File, VEH_CF1 and VEH_CF2 (SAS names changed to be VEH_SC1 and VEH_SC2 in 2010) and driver-related-factors, also in the Vehicle File, namely DR_CF1, DR_CF2, DR_CF3 and (DR_CF4 since 1997). SAS names changed to be DR_SF1, DR_SF2, DR_SF3, and DR_SF4 in 2010. There are also crash-related-factors CF1, CF2, and CF3 in the Accident File.

Note the FARS analyst may have used any of the three variables to code a related factor. One must test all three variables to insure that the selected related factor is included.

Person-related-factors for all drivers are coded 00. Person-related-factors for non-drivers can have non-zero values as listed below.

For 1975 to 1981, values 02 to 06 correspond to 01 to 05 for the 1982 and later data. Values of 20 and higher correspond directly the same values for 1982 and later.

Some information that had been collected under Driver Level Related Factors is now captured in NM14, Condition (Impairment) at Time of Crash (Non-Motorist) or in two new Non-Motor Vehicle Occupant elements; NM11, Non-Motorist Action/Circumstances Prior to Crash and NM12, Non-Motorist Action/Circumstances at Time of Crash.

SAS Name:	P_CF1, P_CF2, P_CF3	1975-2009
	P_SF1, P_SF2, P_SF3	2010-Later

Attribute Codes**1975-1981**

- 00 Not Applicable - Driver/None - All Other Persons
- 01 Physical Impairments
- 02 Not Visible
- 03 Darting or Running into Road
- 04 Improper Crossing of Roadway or Intersection
- 05 Walking/Riding With or Against Traffic, Playing, Working, Sitting, Lying, Standing, etc., in Roadway
- 06 Interfering with Driver (*Since 1976*)

NON-MOTOR-VEHICLE-OPERATOR-RELATED FACTORS:

- 20 Leaving Vehicle Unattended in Roadway
- 21 Overloading or Improper Loading of Vehicle with Passengers or Cargo
- 22 Towing or Pushing Vehicle Improperly
- 23 Failing to Have Lights on When Required
- 24 Operating Without Required Equipment
- 25 Creating Unlawful Noise or Using Equipment Prohibited by Law
- 26 Following Improperly
- 27 Improper or Erratic Lane-Changing
- 28 Failure to Keep in Proper Lane or Running off Road
- 29 Illegal Driving on Road Shoulder, in Ditch, on Sidewalk, on Median
- 30 Making Improper Entry to or Exit from Trafficway

P26/NM25 Related Factors- Person Level (continued)**Attribute Codes****1975-1981**

- 33 Passing Where Prohibited by Posted Signs, Pavement Markings, Hill, or Curve, or School Bus Displaying Warning Not to Pass
- 34 Passing on Wrong Side
- 35 Passing with Insufficient Distance or Inadequate Visibility or Failing to Yield to Overtaking Vehicle
- 36 Operating the Vehicle in Other Erratic, Reckless, Careless or Negligent Manner
- 38 Failure to Yield Right of Way
- 39 Failure to Obey Traffic Signs, Traffic Control Devices or Traffic Officers, Failure to Observe Safety Zone
- 40 Passing Through or Around Barrier Positioned to Prohibit or Channel Traffic
- 41 Failure to Observe Warnings or Instructions on Vehicles Displaying Them
- 42 Failure to Signal Intentions
- 43 Giving Wrong Signal
- 44 Driving Too Fast for Conditions or in Excess of Posted Speed Limit
- 45 Driving Less Than Posted Maximum
- 46 Operating at Erratic or Suddenly Changing Speeds
- 47 Making Right Turn from Left Turn Lane or Making Left Turn from Right Turn Lane
- 48 Making Improper Turn
- 49 Driving Wrong Way on One-Way Roadway
- 50 Driving on Wrong Side of Road
- 51 Operator Inexperience
- 52 Unfamiliar with Roadway
- 99 Unknown

**1982- 2010-
2009 Later**

- 00 00 None/Not Applicable-Driver
- 01 -- Not Visible
- 02 -- Darting, Running or Stumbling (*Since 1995*) Into Roadway
- 03 -- Improper Crossing or Roadway or Intersection
- 04 -- Walking/Riding With or Against Traffic, Playing, Working, Sitting, Lying, Standing Etc. In Roadway
- 05 05 Interfering With Driver
- 06 -- Ill, Passed Out (*Since 1995*)/Blackout
- 07 -- Emotional (*e.g., Depression, Angry, Disputed*)
- 08 08 Mentally Challenged (*Since 1995*)
- 09 09 Construction/Maintenance/Utility Worker (*Since 1995*) Highway Department, Contractor, Utility Company Personnel, etc.
- 10 -- Inattentive
- 11 -- Walking With Cane or Crutches
- 12 -- Restricted to Wheelchair
- 13 -- Paraplegic (*1982-1994 Only*)
- 13 13 Motorized Wheelchair Rider (*Since 1998*)
- 14 -- Impaired Due to Previous Injury

P26/NM25 Related Factors- Person Level (continued)**Attribute Codes**

**1982- 2010-
2009- Later**

15	--	Deaf (1982-1994)
15	--	Under the Influence of Alcohol, Drugs, or Medication (Since 2008)
16	--	Blind
17	--	Other Physical Impairment
18	18	Mother of Dead Fetus
19	--	Pedestrian
<i>NON-MOTOR-VEHICLE-OPERATOR-RELATED FACTORS:</i>		
20	--	Leaving Vehicle Unattended in Roadway (1982-1994)
20	--	Running off Road (2000 and 2001 Only)
21	21	Overloading or Improper Loading of Vehicle with Passengers or Cargo
22	--	Towing or Pushing Vehicle Improperly (Before 2003)
23	--	Failing to [Dim Lights or, Since 1995] Have Lights on When Required
24	--	Operating Without Required Equipment
25	--	Creating Unlawful Noise or Using Equipment Prohibited by Law (1982-2002)
26	26	Following Improperly
27	--	Improper or Erratic Lane Changing
28	--	Failure to Keep in Proper Lane or Running off Road (1982-1999)
28	28	Failure to Keep in Proper Lane (2000 and Later)
29	29	Illegal Driving on Road Shoulder, in Ditch, on Sidewalk, on Median
30	--	Making Improper Entry to or Exit from Trafficway
32	32	Opening Vehicle Closure into Moving Traffic or While Vehicle is in Motion (Since 2001)
33	33	Passing where Prohibited by Posted Signs, Pavement Markings, Hill or Curve, or School Bus Displaying Warning not to Pass Line
34	--	Passing on Wrong Side
35	--	Passing with Insufficient Distance or Inadequate Visibility or Failing to Yield to Overtaking Vehicle
36	--	Operating the Vehicle in Other Erratic, Reckless, Careless or Negligent Manner (or Operating at Erratic or Suddenly Changing Speeds, Since 1995)
37	37	Traveling on Prohibited Trafficway (Since 1995)
38	--	Failure to Yield Right of Way
39	--	Failure to Obey Actual Traffic Signs, Traffic Control Devices or Traffic Officers; Failure to Obey Safety Zone Traffic Laws
40	40	Passing Through or Around Barrier Positioned to Prohibit or Channel Traffic
41	41	Failure to Observe Warnings or Instructions on Vehicles Displaying Them
42	42	Failure to Signal Intentions
43	--	Giving Wrong Signal (1982-1996)
44	44	Driving Too Fast for Conditions or in Excess of Posted Maximum
45	45	Driving Less Than Posted Maximum
46	--	Operating at Erratic or Suddenly Changing Speeds (1982-1996)
47	47	Making Right Turn From Left-Turn Lane, Left Turn from Right-Turn Lane
48	--	Making Other Improper Turn
49	--	Driving Wrong Way on One-Way Trafficway

P26/NM25 Related Factors- Person Level (continued)**Attribute Codes**

**1982- 2010-
2009- Later**

50	--	Driving on Wrong Side of Road (<i>Intentional or Unintentional, Since 1995</i>)
51	51	Operator Inexperience
52	52	Unfamiliar with Roadway
53	--	Stopping in Roadway (<i>Vehicle Not Abandoned</i>)
54	--	Underriding a Parked Truck (<i>1982-1996</i>)
55	--	Getting Off/Out of or On/Into Moving Transport Vehicle
56	--	Getting Off/Out of or On/Into Non-Moving Transport Vehicle (<i>1982-2001</i>)
56	56	Non-Driver Flees Scene (<i>Since 2005</i>)
57	57	Improper Tire Pressure (<i>Since 1995</i>)
58	58	Locked Wheel (<i>Since 1995</i>)
59	59	Overcorrecting (<i>Since 1995</i>)

VISION OBSCURED BY

60	60	Rain, Snow, Fog, Smoke, Sand, Dust
61	61	Reflected Glare, Bright Sunlight, Headlights
62	62	Curve, Hill, or Other Design Features (<i>Including Traffic Signs, Embankment</i>)
63	63	Building, Billboard, Other Structures (<i>Since 1995</i>)
64	64	Trees, Crops, Vegetation
65	65	Motor Vehicle (<i>Including Load</i>)
66	66	Parked Vehicle
67	67	Splash or Spray or Passing Vehicle
68	68	Inadequate Lighting System
69	69	Obstructing Angles on Vehicle
70	70	Mirrors
71	--	Mirrors-Other(<i>1982-2002</i>)
72	72	Other Visual Obstruction

AVOIDING, SWERVING, OR SLIDING DUE TO

73	73	Severe Crosswind
74	74	Wind From Passing Truck
75	75	Slippery or Loose Surface
76	76	Tire Blow-Out or Flat
77	77	Debris or Objects in Road
78	78	Ruts, Holes, Bumps in Road
79	--	Live Animals in Road
80	80	Vehicle in Road
81	81	Phantom Vehicle
82	--	Pedestrian, Pedalcyclist, or Other Non-Motorist
--	82	Pedestrian, Pedalcyclist, or Persons on Personal Conveyances
83	83	Ice, Snow, Slush, Water, Sand, Dirt, Oil, Wet Leaves on Road (<i>Since 1995</i>)

OTHER NON-MOTORIST FACTORS

84	--	Jay Walk (<i>1982-1994</i>)
85	--	Jog (<i>1982-1994</i>)
86	86	Emergency Services Personnel (<i>Since 2007</i>)

P26/NM25 Related Factors- Person Level (continued)

Attribute Codes**1982- 2010-
2009- Later**

87	87	Police or Law Enforcement Officer (<i>Since 2002</i>)
88	88	Seat Back Not in Normal Upright Position, Seat Back Reclined (<i>Since 2002</i>)
90	90	Non-Motorist Pushing a Vehicle
91	91	Portable Electronic Devices (<i>Since 2008</i>)
99	99	Unknown

Automatic Restraint (discontinued)

Definition: This variable was discontinued after 1990.

Additional Information:

SAS Name: AUT_REST

Attribute Codes

1975-1989

- 0 Non-Motorist or Not Applicable
- 1 Automatic Belt in Use
- 2 Automatic Belt Not in Use
- 3 Deployed Air Bag (*No Data 1983-1985*)
- 4 Non-Deployed Air Bag (*No Data 1983-1987*)
- 5 Passive Belt (*i.e., Passive Belt In Use, 1977-1979 Only*)
- 9 Unknown

1990

- 0 Non-Motorist
- 3 Deployed Air Bag
- 4 Non-Deployed Air Bag
- 9 Unknown

Manual Restraint (discontinued)

Definition: This variable was discontinued after 1990.

Additional Information:

SAS Name: `MAN_REST`

Attribute Codes**1975-1990**

- 0 None Used - Vehicle Occupant; Not Applicable - Non-Motorist
- 1 Shoulder Belt
- 2 Lap Belt
- 3 Lap and Shoulder Belt
- 4 Child Safety Seat
- 5 Motorcycle Helmet
- 8 Restraint Used - Type Unknown or Other Including Other Helmet
- 9 Unknown

SP1 Death Certificate Number

Definition: This element identifies the four digit GSA code for the City where the death occurred, the two digit state number and the six digit sequence number from the death certificate as assigned by the State Vital Statistics or Vital Records Department.

Additional Information:

SAS Name: CERT_NO

Attribute Codes**1991-Later**

000000000000	Not Applicable (<i>Not A Fatality</i>) 12 0's
xxxxxxxxxxxx	Any Numeric Characters
9997xxxxxxxx	No GSA Element for The City
9999xxxxxxxx	City Where Death Occurred Cannot Be Found on Death Certificate
999999999999	Unknown

SP2 Fatal Injury at Work

Definition: This element indicates whether the death certificate identified this person as being "at work" at the time of the crash.

Additional Information:

SAS Name: WORK_INJ

Attribute Codes**1987-Later**

- 0 No (*The Injury Was Not At Work*)
- 1 Yes (*The Injury Was At Work*)
- 8 Not Applicable (*Not A Fatality*)
- 9 Unknown

SP3A Race

Definition: This element indicates the race of this person from the death certificate.

Additional Information: This variable is only coded for fatalities.

SAS Name: RACE

Attribute Codes

1999- 2000	2001- Later	
00	00	Not A Fatality <i>(Not Applicable)</i>
01	01	White
02	02	Black
03	03	American Indian <i>(Includes Aleuts and Eskimos)</i>
04	04	Chinese
05	05	Japanese
06	06	Hawaiian <i>(Includes Part-Hawaiian)</i>
07	07	Filipino
18	18	Asian Indian
19	19	Other Indian <i>(Includes South and Central America, Since 2000)</i>
28	28	Korean
38	38	Samoan
48	48	Vietnamese
58	58	Guamanian
68	68	Other Asian or Pacific Islander
78	--	Combined Other Asian Or Pacific Islander, Includes Elements 18-68 For Areas That Do Not Report Them Separately
--	78	Asian Or Pacific Islander, No Specific <i>(Individual)</i> Race
97	97	Multiple Races <i>(Individual Races Not Specified; ex., "Mixed", Since 2000)</i>
--	98	All Other Races
99	99	Unknown

SP3B Hispanic Origin

Definition: This element indicates the Hispanic origin of this person from the death certificate.

Additional Information: This variable is only coded for fatalities.

SAS Name: **HISPANIC**

Attribute Codes

1999- 2000	2001- Later	
00	00	Not a Fatality, Not Applicable
01	01	Mexican
02	02	Puerto Rican
03	03	Cuban
04	04	Central or South American
05	--	Other or Unknown Hispanic (1999)
05	05	European Spanish (Since 2000)
06	--	Hispanic, Origin Not Specified (1999)
06	--	Other Hispanic Origin (Since 2000)
--	06	Hispanic, Origin Not Specified or Other Origin
07	07	Non-Hispanic
99	99	Unknown

NM4 Number of Motor Vehicle Striking Non-Motorist

Definition: This element captures the vehicle number of the in-transport vehicle that made contact with this non-motorist.

Additional Information: This element applies only to non-motorists/non-occupants and reflects the vehicle that made contact with the non-motorist/non-occupant being coded.

The number must match the vehicle number of the striking vehicle. This number is similar to VEH_NO, except that the non-motorist/non-occupant was struck by the vehicle, rather than being within the vehicle.

SAS Name: **N_MOT_NO**

Attribute Codes

1982- 2008	2009	2010- Later	
00	000	000	Not Applicable-Vehicle Occupant
01-98	001-998	001-998	Assigned Vehicle Number
99	999	999	Unknown

NM10 Non-Motorist Location at Time of Crash

Definition: This element identifies the location of the non-motorist with respect to the roadway at the time of the crash.

Additional Information:

SAS Name: LOCATION

Attribute Codes**1975-1981**

00	Not Applicable-Vehicle Occupant
01	Intersection-In Crosswalk
02	Intersection-Sidewalk, Median, Island, Shoulder, Other
03	Intersection-On Roadway
04	Intersection-Unknown
05	Non-Intersection-In Crosswalk
06	Non-Intersection-Sidewalk, Median, Island, Shoulder, Other
07	Non-Intersection-Bike Path
08	Non-Intersection-On Road Shoulder
09	Non-Intersection-Outside Trafficway
10	Non-Intersection-On Roadway
11	Non-Intersection-In Parking Lane (<i>Since 1980</i>)
12	Non-Intersection-Unknown
99	Unknown

**1982- 2010-
2009 Later**

00	00	Not Applicable-Vehicle Occupant (Includes Railway Train Occupants Since 2006)
01	--	Intersection-In Crosswalk
--	01	Intersection-In Marked Crosswalk
02	--	Intersection-On Roadway, Not in Crosswalk
--	02	Intersection-Unmarked Crosswalk
03	--	Intersection-On Roadway, Crosswalk not Available
--	03	Intersection-Not in Crosswalk
04	--	Intersection-On Roadway, Crosswalk Availability Unknown
05	--	Intersection-Not on Roadway
09	09	Intersection-Unknown Location
10	--	Non-Intersection-In Crosswalk
--	10	Non-Intersection-In Marked Crosswalk
11	--	Non-Intersection-On Roadway, Not in Crosswalk
--	11	Non-Intersection-On Roadway, Not in Marked Crosswalk
12	--	Non-Intersection-On Roadway, Crosswalk not Available
13	13	Non-Intersection-On Roadway, Crosswalk Availability Unknown
14	--	Non-Intersection-In Parking Lane
--	14	Parking Lane/Zone
15	--	Non-Intersection-On Road Shoulder
16	--	Non-Intersection-Bike Path
--	16	Bicycle Lane

NM10 Non-Motorist Location at Time of Crash (continued)

Attribute Codes

1982- 2009	2010- Later	
17	--	Non-Intersection-Outside Trafficway
18	--	Non-Intersection-Other, Not a Roadway
19	--	Non-Intersection-Unknown
--	20	Shoulder/Roadside
--	21	Sidewalk
--	22	Median/Crossing Island
--	23	Driveway Access
--	24	Shared-Use Path/Trail
--	25	Non-Trafficway Area
--	28	Other
--	98	Not Reported
99	99	Unknown Location

The CEVENT Data Set

The Cevent data set contains the variables ST_CASE, STATE and EVENTNUM. ST_CASE and EVENTNUM are the case identifiers. The data set also contains:

C17 Vehicle Number (This Vehicle)

Definition: This element represents the number assigned to an in transport motor vehicle involved in the event. This variable is the same as VEH_NO in the Vehicle data set.

Additional Information:

SAS Name: **VNUMBER1**

Attribute Codes***2010-Later***

1-999 Vehicle Number

C17 Area of Impact (This Vehicle)

Definition: This element indicates the impact point that produced property damage or personal injury for this transport motor vehicle involved in the event.

Additional Information:

SAS Name: AOI1

Attribute Codes

00	Non-Collision
01-12	Clock Points
13	Top
14	Undercarriage
18	Set-In-Motion (Not a Clock Point)
61	Left
62	Left-Front Half
63	Left-Back Half
81	Right
82	Right-Front Half
83	Right-Back Half
98	Not Reported
99	Unknown

V31 Sequence of Events

Definition: The events in sequence related to this motor vehicle, regardless of injury and/or property damage. Events for the vehicle are recorded in the order in which they occur, time-wise, from the Police Accident Report (PAR) narrative and diagram.

Additional Information: From 2004 to 2009, Sequence of Events was collected at the vehicle level and up to six events (SEQ1-SEQ6) were stored in the Vehicle data set.

SAS Name: **SOE**

Attribute Codes**2010-Later**

- 01 Rollover/Overturn
- 02 Fire/Explosion
- 03 Immersion
- 04 Gas Inhalation
- 05 Fell/Jumped from Vehicle
- 06 Injured in Vehicle (Non-Collision)
- 07 Other Non-Collision
- 08 Pedestrian
- 09 Pedalcyclist
- 10 Railway Vehicle
- 11 Live Animal
- 12 Motor Vehicle in Transport
- 14 Parked Motor Vehicle
- 15 Non-Motorist on Personal Conveyance
- 16 Thrown or Falling Object
- 17 Boulder
- 18 Other Object (Not Fixed)
- 19 Building
- 20 Impact Attenuator/Crash Cushion
- 21 Bridge Pier or Support
- 23 Bridge Rail (Includes Parapet)
- 24 Guardrail Face
- 25 Concrete Traffic Barrier
- 26 Other Traffic Barrier
- 30 Utility Pole/Light Support
- 31 Other Post, Other Pole, or Other Support
- 32 Culvert
- 33 Curb
- 34 Ditch
- 35 Embankment
- 38 Fence
- 39 Wall
- 40 Fire Hydrant

V31 Sequence of Events (continued)

Attribute Codes**2010-Later**

- 41 Shrubbery
- 42 Tree (*Standing Only*)
- 43 Other Fixed Object
- 44 Pavement Surface Irregularity (*Ruts, Potholes, Grates, etc.*)
- 45 Working Motor Vehicle
- 46 Traffic Signal Support
- 48 Snow Bank
- 49 Ridden Animal or Animal-Drawn Conveyance (*Since 1998*)
- 50 Bridge Overhead Structure
- 51 Jackknife (*Harmful to This Vehicle*)
- 52 Guardrail End
- 53 Mail Box
- 54 Motor Vehicle In-Transport Strikes or is Struck by Cargo, Persons or Objects Set-in-Motion from/by Another Motor Vehicle In-Transport
- 55 Motor Vehicle in Motion Outside the Trafficway (*Since 2008*)
- 57 Cable Barrier (*Since 2008*)
- 58 Ground
- 59 Traffic Sign Support
- 60 Cargo/Equipment Loss or Shift (*Non-Harmful*)
- 61 Equipment Failure (*Blown Tire, Brake Failure, etc.*)
- 62 Separation of Units
- 63 Ran Off Road - Right
- 64 Ran Off Road - Left
- 65 Cross Median
- 66 Downhill Runaway
- 67 Vehicle Went Airborne
- 68 Cross Centerline
- 69 Re-Entering Highway
- 70 Jackknife (*Non-Harmful*)
- 72 Cargo/Equipment Loss or Shift (*Harmful To This Vehicle*)
- 98 Not Reported
- 99 Unknown

C17 Vehicle Number (Other Vehicle)

Definition: This element represents the number assigned to an in transport motor vehicle involved in the event. This variable is the same as VEH_NO in the Vehicle data set.

Additional Information:

SAS Name: **VNUMBER2**

Attribute Codes***2010-Later***

1-999 Vehicle Number

C17 Area of Impact (Other Vehicle)

Definition: This element indicates the impact point for the other in transport motor vehicle involved in the harmful event.

Additional Information:

SAS Name: AOI2

Attribute Codes

00	Non-Collision
01-12	Clock Points
13	Top
14	Undercarriage
61	Left
62	Left-Front Half
63	Left-Back Half
81	Right
82	Right-Front Half
83	Right-Back Half
98	Not Reported
99	Unknown

The VEVENT Data Set

The Vevent data set contains the variables ST_CASE, STATE, VEVENTNUM, EVENTNUM and VEH_NO. ST_CASE, VEVENTNUM, EVENTNUM and VEH_NO are the case identifiers. The VEVENTNUM is the number of event sequentially ordered for each vehicle. The data set also contains:

C17 Vehicle Number (This Vehicle)

Definition: This element represents the number assigned to an in transport motor vehicle involved in the event. This variable is the same as VEH_NO in the Vehicle data set.

Additional Information:

SAS Name: **VNUMBER1**

Attribute Codes

2010-Later

1-999 Vehicle Number

C17 Area of Impact (This Vehicle)

Definition: This element indicates the impact point that produced property damage or personal injury for this transport motor vehicle involved in the event.

Additional Information:

SAS Name: AOI1

Attribute Codes

00	Non-Collision
01-12	Clock Points
13	Top
14	Undercarriage
18	Set-In-Motion (Not a Clock Point)
61	Left
62	Left-Front Half
63	Left-Back Half
81	Right
82	Right-Front Half
83	Right-Back Half
98	Not Reported
99	Unknown

V31 Sequence of Events

Definition: The events in sequence related to this motor vehicle, regardless of injury and/or property damage. Events for the vehicle are recorded in the order in which they occur, time-wise, from the Police Accident Report (PAR) narrative and diagram.

Additional Information: Starting in 2004 the HARM_EV, M_HARM and the sequence of event variables, (SEQ_i, 1 ≤ i ≤ 6) have the same values. The harmful event values were modified to be consistent with the sequence of event variables.

SAS Name: **SOE** 2010-Later

Attribute Codes**2010-Later**

- 01 Rollover/Overturn
- 02 Fire/Explosion
- 03 Immersion
- 04 Gas Inhalation
- 05 Fell/Jumped from Vehicle
- 06 Injured in Vehicle (Non-Collision)
- 07 Other Non-Collision
- 08 Pedestrian
- 09 Pedalcyclist
- 10 Railway Vehicle
- 11 Live Animal
- 12 Motor Vehicle in Transport
- 14 Parked Motor Vehicle
- 15 Non-Motorist on Personal Conveyance
- 16 Thrown or Falling Object
- 17 Boulder
- 18 Other Object (Not Fixed)
- 19 Building
- 20 Impact Attenuator/Crash Cushion
- 21 Bridge Pier or Support
- 23 Bridge Rail (Includes Parapet)
- 24 Guardrail Face
- 25 Concrete Traffic Barrier
- 26 Other Traffic Barrier
- 30 Utility Pole/Light Support
- 31 Other Post, Other Pole, or Other Support
- 32 Culvert
- 33 Curb
- 34 Ditch
- 35 Embankment
- 38 Fence
- 39 Wall
- 40 Fire Hydrant

V31 Sequence of Events (continued)

Attribute Codes**2010-Later**

- 41 Shrubbery
- 42 Tree (*Standing Only*)
- 43 Other Fixed Object
- 44 Pavement Surface Irregularity (*Ruts, Potholes, Grates, etc.*)
- 45 Working Motor Vehicle
- 46 Traffic Signal Support
- 48 Snow Bank
- 49 Ridden Animal or Animal-Drawn Conveyance (*Since 1998*)
- 50 Bridge Overhead Structure
- 51 Jackknife (*Harmful to This Vehicle*)
- 52 Guardrail End
- 53 Mail Box
- 54 Motor Vehicle In-Transport Strikes or is Struck by Cargo, Persons or Objects Set-in-Motion from/by Another Motor Vehicle In-Transport
- 55 Motor Vehicle in Motion Outside the Trafficway (*Since 2008*)
- 57 Cable Barrier (*Since 2008*)
- 58 Ground
- 59 Traffic Sign Support
- 60 Cargo/Equipment Loss or Shift (*Non-Harmful*)
- 61 Equipment Failure (*Blown Tire, Brake Failure, etc.*)
- 62 Separation of Units
- 63 Ran Off Road - Right
- 64 Ran Off Road - Left
- 65 Cross Median
- 66 Downhill Runaway
- 67 Vehicle Went Airborne
- 68 Cross Centerline
- 69 Re-Entering Highway
- 70 Jackknife (*Non-Harmful*)
- 72 Cargo/Equipment Loss or Shift (*Harmful To This Vehicle*)
- 98 Not Reported
- 99 Unknown

C17 Vehicle Number (Other Vehicle)

Definition: This element represents the number assigned to an in transport motor vehicle involved in the event. This variable is the same as VEH_NO in the Vehicle data set.

Additional Information:

SAS Name: **VNUMBER2**

Attribute Codes***2010-Later***

1-999 Vehicle Number

C17 Area of Impact (Other Vehicle)

Definition: This element indicates the impact point for the other in transport motor vehicle involved in the harmful event.

Additional Information:

SAS Name: AOI2

Attribute Codes

2010-Later

00	Non-Collision
01-12	Clock Points
13	Top
14	Undercarriage
18	Set-In-Motion (Not a Clock Point)
61	Left
62	Left-Front Half
63	Left-Back Half
81	Right
82	Right-Front Half
83	Right-Back Half
98	Not Reported
99	Unknown

The VSOE Data Set

The Vevent data set contains the variables ST_CASE, STATE, VEVENTNUM, EVENTNUM and VEH_NO. ST_CASE, VEVENTNUM, EVENTNUM and VEH_NO are the case identifiers. The VEVENTNUM is the number of event sequentially ordered for each vehicle. The data set also contains:

C17 Area of Impact

Definition: This element indicates the impact point that produced property damage or personal injury for the transport motor vehicle involved in the event.

Additional Information:

SAS Name: AOI

Attribute Codes

00	Non-Collision
01-12	Clock Points
13	Top
14	Undercarriage
18	Set-In-Motion (Not a Clock Point)
61	Left
62	Left-Front Half
63	Left-Back Half
81	Right
82	Right-Front Half
83	Right-Back Half
98	Not Reported
99	Unknown

V31 Sequence of Events

Definition: The events in sequence related to this motor vehicle, regardless of injury and/or property damage. Events for the vehicle are recorded in the order in which they occur, time-wise, from the Police Accident Report (PAR) narrative and diagram.

Additional Information: Starting in 2004 the HARM_EV, M_HARM and the sequence of event variables, (SEQ_i, 1 ≤ i ≤ 6) have the same values. The harmful event values were modified to be consistent with the sequence of event variables.

SAS Name: **SOE** 2010-Later

Attribute Codes**2010-Later**

- 01 Rollover/Overturn
- 02 Fire/Explosion
- 03 Immersion
- 04 Gas Inhalation
- 05 Fell/Jumped from Vehicle
- 06 Injured in Vehicle (Non-Collision)
- 07 Other Non-Collision
- 08 Pedestrian
- 09 Pedalcyclist
- 10 Railway Vehicle
- 11 Live Animal
- 12 Motor Vehicle in Transport
- 14 Parked Motor Vehicle
- 15 Non-Motorist on Personal Conveyance
- 16 Thrown or Falling Object
- 17 Boulder
- 18 Other Object (Not Fixed)
- 19 Building
- 20 Impact Attenuator/Crash Cushion
- 21 Bridge Pier or Support
- 23 Bridge Rail (Includes Parapet)
- 24 Guardrail Face
- 25 Concrete Traffic Barrier
- 26 Other Traffic Barrier
- 30 Utility Pole/Light Support
- 31 Other Post, Other Pole, or Other Support
- 32 Culvert
- 33 Curb
- 34 Ditch
- 35 Embankment
- 38 Fence
- 39 Wall
- 40 Fire Hydrant

V31 Sequence of Events (continued)

Attribute Codes**2010-Later**

- 41 Shrubbery
- 42 Tree (*Standing Only*)
- 43 Other Fixed Object
- 44 Pavement Surface Irregularity (*Ruts, Potholes, Grates, etc.*)
- 45 Working Motor Vehicle
- 46 Traffic Signal Support
- 48 Snow Bank
- 49 Ridden Animal or Animal-Drawn Conveyance (*Since 1998*)
- 50 Bridge Overhead Structure
- 51 Jackknife (*Harmful to This Vehicle*)
- 52 Guardrail End
- 53 Mail Box
- 54 Motor Vehicle In-Transport Strikes or is Struck by Cargo, Persons or Objects Set-in-Motion from/by Another Motor Vehicle In-Transport
- 55 Motor Vehicle in Motion Outside the Trafficway (*Since 2008*)
- 57 Cable Barrier (*Since 2008*)
- 58 Ground
- 59 Traffic Sign Support
- 60 Cargo/Equipment Loss or Shift (*Non-Harmful*)
- 61 Equipment Failure (*Blown Tire, Brake Failure, etc.*)
- 62 Separation of Units
- 63 Ran Off Road - Right
- 64 Ran Off Road - Left
- 65 Cross Median
- 66 Downhill Runaway
- 67 Vehicle Went Airborne
- 68 Cross Centerline
- 69 Re-Entering Highway
- 70 Jackknife (*Non-Harmful*)
- 72 Cargo/Equipment Loss or Shift (*Harmful To This Vehicle*)
- 98 Not Reported
- 99 Unknown

The FACTOR Data Set

The Factor data set contains the variables ST_CASE, STATE, VEH_NO and MFACTOR. ST_CASE, VEH_NO and MFACTOR are the case identifiers. MFACTOR identifies each vehicle factor (as a separate record) and is described below:

PC4 Contributing Circumstances, Motor Vehicle

Definition: This element describes the possible pre-existing motor vehicle defects or maintenance conditions that may have contributed to the crash.

Additional Information: Most of these elements can be found in Related Factor- Vehicle Level (SAS names VEH_CF1 and VEH_CF2 in the Vehicle data set in 2009 and prior, and VEH_SC1-VEH_SC2 in 2010).

SAS Name: **MFACTOR**

Attribute Codes***2010-Later***

00	None
01	Tires
02	Brake System
03	Steering
04	Suspension
05	Power Train
06	Exhaust System
07	Head Lights
08	Signal Lights
09	Other Lights
10	Wipers
11	Wheels
12	Mirrors
13	Windows/Windshield
14	Body, Doors
15	Truck Coupling / Trailer Hitch / Safety Chains
16	Safety Systems
17	Vehicle Contributing Factors - No Details
97	Other
98	Not Reported
99	Unknown

The VIOLATN Data Set

The Violatn data set contains the variables ST_CASE, STATE, VEH_NO and MVIOLATN. ST_CASE, VEH_NO and MVIOLATN are the case identifiers. MVIOLATN identifies each violation (as a separate record) and is described below:

D21 Violations Charged

Definition: This element identifies all violations charged to this driver in this crash.

Additional Information: Prior to 2010, this variable was in the Vehicle data set. In 2010, this variable changed to identify all violations charged in the crash and was therefore moved here to its own data set.

SAS Name: **MVIOLATN**

Attribute Codes**2010-Later**

00 None

RECKLESS/CARELESS/HIT-AND-RUN OFFENSES

- 01 Manslaughter or Homicide
- 02 Willful Reckless Driving; Driving to Endanger; Negligent Driving
- 03 Unsafe Reckless (*Not Willful, Wanton Reckless*) Driving
- 04 Inattentive, Careless, Improper Driving
- 05 Fleeing or Eluding Police
- 06 Fail to Obey Police, Fireman, Authorized Person Directing Traffic
- 07 Hit-and-Run, Fail to Stop After Crash
- 08 Fail to Give Aid, Information, Wait for Police after Crash
- 09 Serious Violation Resulting in Death

IMPAIRMENT OFFENSES

- 11 Driving While Intoxicated (*Alcohol or Drugs*) or BAC above Limit (*Any Detectable BAC for CDLs*)
- 12 Driving While Impaired
- 13 Driving under Influence of Substance not intended to intoxicate
- 14 Drinking While Operating
- 15 Illegal Possession of Alcohol or Drugs
- 16 Driving With Detectable Alcohol
- 18 Refusal to Submit to Chemical Test
- 19 Alcohol, Drug, or Impairment Violations Generally

SPEED-RELATED OFFENSES

- 21 Racing
- 22 Speeding (*Above the Speed Limit*)
- 23 Speed Greater Than Reasonable and Prudent (*Not Necessarily Over the Limit*)
- 24 Exceeding Special Speed Limit (*e.g., for Trucks, Buses, Cycles, or on Bridge, in School Zone, etc.*)
- 25 Energy Speed (*Exceeding 55 mph, Non-Pointable*)
- 26 Driving Too Slowly
- 29 Speed-Related Violations Generally

D21 Violations Charged (continued)

2010-Later*RULES OF THE ROAD – TRAFFIC SIGN & SIGNALS*

- 31 Fail to Stop for Red Signal
- 32 Fail to Stop for Flashing Red
- 33 Violation of Turn on Red (*Fail to Stop & Yield, Yield to Pedestrians before Turning*)
- 34 Fail to Obey Flashing Signal (*Yellow or Red*)
- 35 Fail to Obey Signal Generally
- 36 Violate RR Grade Crossing Device/Regulations
- 37 Fail to Obey Stop Sign
- 38 Fail to Obey Yield Sign
- 39 Fail to Obey Traffic Control Device Generally

RULES OF THE ROAD – TURNING, YIELDING, SIGNALING

- 41 Turn in Violation of Traffic Control (Disobey Signs, Turn Arrow or Pavement Markings; this is not a Right-on-Red violation)
- 42 Improper Method & Position of Turn (Too Wide, Wrong Lane)
- 43 Fail to Signal for Turn or Stop
- 45 Fail to Yield to Emergency Vehicle
- 46 Fail to Yield Generally
- 48 Enter Intersection When Space Insufficient
- 49 Turn, Yield, Signaling Violations Generally

RULES OF THE ROAD – WRONG SIDE, PASSING & FOLLOWING

- 51 Driving Wrong Way on One-Way Road
- 52 Driving on Left, Wrong Side of Road Generally
- 53 Improper, Unsafe Passing
- 54 Pass on Right (*Drive off Pavement to Pass*)
- 55 Pass Stopped School Bus
- 56 Fail to Give Way When Overtaken
- 58 Following Too Closely
- 59 Wrong Side, Passing, Following Violations Generally

RULES OF THE ROAD – LANE USAGE

- 61 Unsafe or Prohibited Lane Change
- 62 Improper Use of Lane (*Enter of 3-Lane Road, HOV Designated Lane*)
- 63 Certain Traffic to Use Right Lane (*Trucks, Slow Moving, etc.*)
- 66 Motorcycle Lane Violations (*More than two per Lane, Riding Between Lanes, etc.*)
- 67 Motorcyclist Attached to another Vehicle
- 69 Lane Violations Generally

NON-MOVING – LICENSE & REGISTRATION VIOLATIONS

- 71 Driving While License Withdrawn
- 72 Other Driver License Violations
- 73 Commercial Driver Violations
- 74 Vehicle Registration Violations
- 75 Fail to Carry Insurance Card
- 76 Driving Uninsured Vehicle
- 79 Non-Moving Violations Generally

D21 Violations Charged (continued)

2010-Later*EQUIPMENT*

- 81 Lamp Violations
- 82 Brake Violations
- 83 Failure to Require Restraint Use (*by Self or Passenger*)
- 84 Motorcycle Equipment Violations (*Helmet, Special Equipment*)
- 85 Violation of Hazardous Cargo Regulations
- 86 Size, Weight, Load Violations
- 89 Equipment Violations Generally

OTHER VIOLATIONS

- 91 Parking
- 92 Theft, Unauthorized Use of Motor Vehicle
- 93 Driving Where Prohibited (*Sidewalk, Limited Access, Off Truck Route*)
- 97 Not Reported
- 98 Other Moving Violation
- 99 Unknown Violation

The VISION Data Set

The Vision data set contains the variables ST_CASE, STATE, VEH_NO and MVISOBSC. ST_CASE, VEH_NO and MVISOBSC are the case identifiers. MVISOBSC identifies each visual obstruction (as a separate record) and is described below:

PC14 Driver's Vision Obscured by

Definition: This element records impediments to a driver's visual field that were noted in the case materials.

Additional Information: Most of these elements can be found in "Related Factor – Driver Level" from 1982 to 2008. This variable was added to the Vehicle data set in 2009. In 2010, the variable was changed to identify all that apply in the crash and was therefore moved here to its own data set.

SAS Name: **MVISOBSC**

Attribute Codes**2010-Later**

- 00 No Obstruction Noted
- 01 Rain, Snow, Fog, Smoke, Sand, Dust
- 02 Reflected Glare, Bright Sunlight, Headlights
- 03 Curve, Hill, or Other Roadway Design Features
- 04 Building, Billboard, or Other Structure
- 05 Trees, Crops, Vegetation
- 06 In-Transport Motor Vehicle (*including load*)
- 07 Not-in-Transport Motor Vehicle (parked, working)
- 08 Splash or Spray of Passing Vehicle
- 09 Inadequate Defrost or Defog System
- 10 Inadequate Vehicle Lighting System
- 11 Obstructing Interior to the Vehicle
- 12 External Mirrors
- 13 Broken or Improperly Cleaned Windshield
- 14 Obstructing Angles on Vehicle
- 95 No Driver Present
- 97 Vision Obscured – No Details
- 98 Other Visual Obstruction
- 99 Unknown

The MANEUVER Data Set

The Maneuver data set contains the variables ST_CASE, STATE, VEH_NO and MDRMANAV. ST_CASE, VEH_NO and MDRMANAV are the case identifiers. MDRMANAV identifies each avoidance attempt (as a separate record) and is described below:

PC15 Driver Maneuvered to Avoid

Definition: This element identifies the thing(s) the driver attempted to avoid while the vehicle was on the road portion of the trafficway, just prior to the first harmful event for this vehicle.

Additional Information:

SAS Name: MDRMANAV

Attribute Codes**2010-Later**

- 00 Driver Did Not Maneuver To Avoid
- 01 Object
- 02 Poor Road Conditions (*Puddle, Ice, Pothole, etc.*)
- 03 Live Animal
- 04 Motor Vehicle
- 05 Pedestrian, Pedalcyclist or Other Non-Motorist
- 92 Phantom/Non-Contact Motor Vehicle
- 95 No Driver Present
- 98 Not Reported
- 99 Unknown

The DISTRACT Data Set

The Distract data set contains the variables ST_CASE, STATE, VEH_NO and MDRDSTRD. ST_CASE, VEH_NO and MDRDSTRD are the case identifiers. MDRDSTRD identifies each distraction (as a separate record) and is described below:

PC16 Driver Distracted By

Definition: This element identifies the attribute(s) which best describe this driver's attention to driving prior to the driver's realization of an impending critical event or just prior to impact if realization of an impending critical event does not occur.

Additional Information:

SAS Name: **MDRDSTRD**

Attribute Codes***2010-Later***

- 00 Not Distracted
- 01 Looked But Did Not See
- 03 By Other Occupant(s)
- 04 By Moving Object in Vehicle
- 05 While Talking or Listening to Cellular Phone
- 06 While Dialing Cellular Phone
- 07 Adjusting Audio and/or Climate Controls
- 09 While Using Other Device/Controls Integral to Vehicle
- 10 While Using or Reaching For Device/Object Brought Into Vehicle
- 12 Distracted by Outside Person, Object or Event
- 13 Eating or Drinking
- 14 Smoking Related
- 15 Other Cellular Phone Related
- 16 No Driver Present
- 92 Distraction/Inattention, Details Unknown
- 96 Not Reported
- 97 Inattentive or Lost in Thought
- 98 Other Distraction
- 99 Unknown if Distracted

The DRIMPAIR Data Set

The Drimpair data set contains the variables ST_CASE, STATE, VEH_NO, PER_NO and DRIMPAIR. ST_CASE, VEH_NO, PER_NO and DRIMPAIR are the case identifiers. DRIMPAIR identifies each impairment (as a separate record) and is described below:

D23 Condition (Impairment) at Time of Crash- Driver

Definition: This element identifies physical impairments to this driver that may have contributed to the crash as identified by law enforcement.

Additional Information: This element attempts to identify physical impairments to this driver which may have contributed to the cause of the crash. These impairments can appear anywhere in the case materials--in the narrative section, in the violations section, in a column entitled "Contributing Factors" or "Driver Action", etc.

Some information that had been collected under Related Factors- Driver Level is now captured under this new element.

SAS Name: DRIMPAIR

Attribute Codes**2010-Later**

- 00 None/Apparently Normal
- 01 Ill, Blackout
- 02 Asleep or Fatigued
- 03 Walking with a Cane or Crutches
- 04 Paraplegic or Restricted to Wheelchair
- 05 Impaired Due to Previous Injury
- 06 Deaf
- 07 Blind
- 08 Emotional (*Depressed, Angry, Disturbed, etc.*)
- 09 Under the Influence of Alcohol, Drugs or Medication
- 10 Physical Impairment – No Details
- 96 Other Physical Impairment
- 98 Not Reported
- 99 Unknown if Physically Impaired

The NMIMPAIR Data Set

The Nmimpair data set contains the variables ST_CASE, STATE, VEH_NO, PER_NO and NMIMPAIR. ST_CASE, VEH_NO, PER_NO and NMIMPAIR are the case identifiers. NMIMPAIR identifies each impairment (as a separate record) and is described below:

NM14 Condition (Impairment) at Time of Crash- Non-Motorist

Definition: This element identifies physical impairments to the non-motorist that may have contributed to the crash as identified by law enforcement.

Additional Information: This element attempts to identify physical impairments to this non-motorist which may have contributed to the cause of the crash. These impairments can appear anywhere in the case materials--in the narrative section, in the violations section, in a column entitled "Contributing Factors" or "Driver Action", etc.

Some information that had been collected under Related Factors- Person Level is now captured under this new element.

SAS Name: **NMIMPAIR**

Attribute Codes**2010-Later**

- 00 None/Apparently Normal
- 01 Ill, Blackout
- 02 Asleep or Fatigued
- 03 Walking with a Cane or Crutches
- 04 Paraplegic or Restricted to Wheelchair
- 05 Impaired Due to Previous Injury
- 06 Deaf
- 07 Blind
- 08 Emotional (*Depressed, Angry, Disturbed, etc.*)
- 09 Under the Influence of Alcohol, Drugs or Medication
- 10 Physical Impairment – No Details
- 96 Other Physical Impairment
- 98 Not Reported
- 99 Unknown if Physically Impaired

The NMCRAASH Data Set

The Nmcraash data set contains the variables ST_CASE, STATE, PER_NO and MTM_CRSH. ST_CASE, PER_NO and MTM_CRSH are the case identifiers. MTM_CRSH identifies each action (as a separate record) and is described below:

NM12 Non-Motorist Action/Circumstances at Time of Crash

Definition: This element describes the action(s) and/or circumstances of the non-motorist that law enforcement indicated may have contributed to the crash.

Additional Information: Some information that had been collected under Person Level Related Factors are now captured under this new element. Please note the "non-motorist" may include people in not-in-transport motor vehicles, however this element is only collected for people who are not occupants of motor vehicles.

SAS Name: **MTM_CRSH**

Attribute Codes**2010-Later**

- 00 No Improper Action
- 01 Dart/Dash
- 02 Failure to Yield Right-Of-Way
- 03 Failure to Obey Traffic Signs, Signals or Officer
- 04 In Roadway Improperly (*Standing, Lying, Working, Playing*)
- 05 Entering/Exiting Vehicle
- 06 Inattentive (*Talking, Eating, etc.*)
- 07 Improper Turn/Merge
- 08 Improper Passing
- 09 Wrong-Way Riding or Walking
- 10 Driving on Wrong Side of Road
- 12 Improper Crossing of Roadway or Intersection (*Jaywalking*)
- 13 Failing to Have Lights on When Required
- 14 Operating Without Required Equipment
- 15 Improper or Erratic Lane Changing
- 16 Failure to Keep in Proper Lane or Running Off Road
- 17 Making Improper Entry to or Exit from Trafficway
- 18 Operating the Vehicle in Other Erratic, Reckless, Careless or Negligent Manner
- 19 Not Visible (*Dark Clothing, No Lighting, etc.*)
- 20 Passing with Insufficient Distance or Inadequate Visibility or Failing to Yield to Overtaking Vehicle
- 21 Other
- 98 Not Reported
- 99 Unknown

The NMPRIOR Data Set

The Nmprior data set contains the variables ST_CASE, STATE, PER_NO and MPR_ACT. ST_CASE, PER_NO and MPR_ACT are the case identifiers. MPR_ACT identifies each action (as a separate record) and is described below:

NM11 Non-Motorist Action/Circumstances Prior to Crash

Definition: This element describes the action(s) of the non-motorist immediately prior to their involvement in the crash.

Additional Information: Some information that had been collected under Person Level Related Factors are now captured under this new element. Please note the "non-motorist" may include people in not-in-transport motor vehicles, however this element is only collected for people who are not occupants of motor vehicles.

SAS Name: **MPR_ACT**

Attribute Codes**2010-Later**

- 01 Going to or from School (*K-12*)
- 02 Waiting to Cross Roadway
- 03 Crossing Roadway
- 04 Jogging/Running
- 05 Movement Along Roadway with Traffic (*In or Adjacent to Travel Lane*)
- 06 Movement Along Roadway Against Traffic (*In or Adjacent to Travel Lane*)
- 07 Movement on Sidewalk
- 08 In Roadway-Other (*Working, Playing, etc.*)
- 09 Adjacent to Roadway (*e.g., Shoulder, Median*)
- 10 Working in Trafficway (*Incident Response*)
- 11 Entering/Exiting a Vehicle
- 12 Disabled Vehicle Related (*Working on, Pushing, Leaving/Approaching*)
- 14 Other
- 15 None
- 98 Not Reported
- 99 Unknown

The SAFETYEQ Data Set

The Safetyeq data set contains the variables ST_CASE, STATE, PER_NO and MSAFEQMT. ST_CASE, PER_NO and MSAFEQMT are the case identifiers. MSAFEQMT identifies each item of safety equipment (as a separate record) and is described below:

NM13 Non-Motorist Safety Equipment

Definition: This element indicates the safety equipment that was used by the non-motorist involved in the crash.

Additional Information: There can be one or more safety equipment responses for each nonmotorists.

SAS Name: **MSAFEQMT**

Attribute Codes**2010-Later**

- 1 None Used
- 2 Helmet
- 3 Reflective Equipment/Clothing (*Jacket, Backpack, etc.*)
- 4 Protective Pads Used (*Elbows, Knees, Shins, etc.*)
- 5 Lighting
- 7 Other Safety Equipment
- 8 Not Reported
- 9 Unknown if Used

The PARKWORK Data Set

The Parkwork data set includes Vehicle variables applicable to parked vehicles. It contains the variables ST_CASE, STATE, and VEH_NO. ST_CASE and VEH_NO are the case identifiers. The data set also contains:

C4AA Derived Number of Vehicle Forms Submitted for Motor Vehicle in Transport

Definition: This element records the number of Vehicle forms submitted. It counts the number of vehicles in transport involved in the crash. Legally parked vehicles are not included.

Additional Information: It is unlikely that the number of vehicles involved in the crash is greater than the Number of Vehicle Forms plus two.

1975-1981: *In the event of a hit-and-run crash, if the vehicle information was not known, then no vehicle form was filled out. Likewise, if no information was known on the person level, usually the driver of the unknown vehicle, then a Person Level form was not filled out. The result is that the number of unknowns is much smaller for this time period than 1982 and later.*

Example: From 1975 to 1980, there were 30 to 40 drivers coded with unknown sex, approximately 0.05 percent of all drivers involved in fatal crashes. In 1981 the number of drivers with unknown sex rose to over 300, approximately 0.5 percent of all drivers involved in fatal crashes.

1982-Later: *In the case of a hit-and-run crash, a Vehicle-Driver form and a Person Level form for the driver are filled out. When the information about the vehicle-driver or person is not known -- which is often the case with hit-and-runs -- the values are coded as unknown.*

Example: Between 1982 and 1994, the number of drivers coded with unknown sex fluctuated between 700 and 1,000, approximately 1.5 percent of all drivers involved in fatal crashes. Reviewing the 768 persons in the 1994 Annual Report file, all were drivers and 90 percent of them were involved in hit-and-run crashes.

SAS Name: **PVE_FORMS**

Attribute Codes

1976- 1981	1982- 2008	2009- Later	
00-99	01-99	001-999	Number of Vehicle Forms

V4 **Number of Occupants**

Definition: This element records the number of occupants in each vehicle.

Additional Information: All, some, or none of the individuals may have died in the crash.

SAS Name: **PNUMOCCS** *2009-Later*

Attribute Codes***2010-
Later***

00	None
01-95	The Actual Number of Occupants in The Vehicle
96	96 Or More Occupants in The Vehicle
98	Not Reported
99	Unknown

C8 Crash Date

C8A Month of Crash

Definition: This element identifies the month on which the crash occurred.

Additional Information:

SAS Name: PMONTH

Attribute Codes

1975- 2008	2009- Later	
01	01	January
02	02	February
03	03	March
04	04	April
05	05	May
06	06	June
07	07	July
08	08	August
09	09	September
10	10	October
11	11	November
12	12	December
99	--	Unknown

C8B Day of Crash

Definition: This element identifies the day of the month on which the crash occurred.

Additional Information:

SAS Name: PDAY

Attribute Codes

1975- 2009	2010- Later	
01-31	01-31	Day of the Month of the Crash
99	--	Unknown

C9 **Crash Time**

C9A **Hour of Crash**

Definition: This element identifies the hour at which the crash occurred.

Additional Information: All time is 24-hour military time.

The time of the crash/arrival of the emergency medical service can occur in a different day than the arrival of emergency medical service at the crash scene/hospital.

If you need to separate day and night, see the variable LGT_COND under the heading Light Condition.

SAS Name: **PHOUR**

1975- 1998	1999- 2008	2009	2010- Later	
00-24	00-24	00-23	00-23	Valid Military Times
--	--	88	--	Not Applicable or Not Notified
99	99	99	99	Unknown

C9B **Minute of Crash**

Definition: This element identifies the minutes after the hour at which the crash occurred.

Additional Information: All time is 24-hour military time.

The time of the crash/arrival of the emergency medical service can occur in a different day than the arrival of emergency medical service at the crash scene/hospital.

SAS Name: **PMINUTE**

1975- 2008	2009	2010- Later	
00-59	00-59	00-59	Valid Military Times
--	88	--	Not Applicable or Not Notified
99	99	99	Unknown

C18 First Harmful Event

Definition: This element is defined as the first injury or damage producing event of the crash.

Additional Information: First harmful event applies to the crash. The most harmful event variable M_HARM applies to the vehicle. Harmful events are judgment calls of the FARS analysts based on the data within the police crash report.

SAS Name: PHARM_EV

Attribute Codes**1975-1981**

- 01 Overturn
- 02 Fire/Explosion
- 03 Immersion
- 04 Gas Inhalation
- 05 Fell from Vehicle
- 06 Injured in Vehicle
- 07 Other Non-Collision
- 08 Pedestrian
- 09 Pedalcycle
- 10 Railway Train
- 11 Animal
- 12 Motor Vehicle in Transport
- 13 Motor Vehicle in Transport in Other Roadway
- 14 Parked Motor Vehicle
- 15 Other Type Non-Motorist
- 16 Other Object
- 17 Bridge or Overpass (1975-1978 Only)
- 18 Building
- 19 Culvert
- 20 Curb or Wall
- 21 Divider
- 22 Embankment
- 23 Fence
- 24 Guard Rail
- 25 Light Support
- 26 Sign Post
- 27 Tree/Shrubbery
- 28 Utility Pole
- 29 Other Pole/Support
- 30 Impact Attenuator
- 31 Other Fixed Object
- 32 Bridge or Overpass [Passing Under] (1979-1981 Only)
- 33 Bridge or Overpass [Passing Over] (1979-1981 Only)
- 99 Unknown

C18 First Harmful Event (continued)**Attribute Codes**

1982- 2003	2004- 2009	2010- Later	
01	01	01	Rollover/Overturn
02	02	02	Fire/Explosion
03	03	03	Immersion
04	04	04	Gas Inhalation
05	05	05	Fell/Jumped from Vehicle
06	06	--	Injured in Vehicle
--	--	06	Injured in Vehicle (<i>Non-Collision</i>)
07	07	07	Other Non-Collision
08	08	08	Pedestrian
09	09	--	Pedalcycle
--	--	09	Pedalcyclist
10	10	--	Railway Train
--	--	10	Railway Vehicle
11	11	--	Animal
--	--	11	Live Animal
12	12	--	Motor Vehicle in Transport on Same Roadway
--	--	12	Motor Vehicle in Transport
13	13	--	Motor Vehicle in Transport on Other Roadway
14	14	14	Parked Motor Vehicle (<i>Not In Transport</i>)
15	--	--	Other Type Non-Motorist
--	15	15	Non-Motorist on Personal Conveyance
16	16	16	Thrown or Falling Object
17	17	17	Boulder
18	18	18	Other Object (<i>Not Fixed</i>)
19	19	19	Building
20	20	20	Impact Attenuator/Crash Cushion
21	21	--	Bridge Pier or Abutment
--	--	21	Bridge Pier or Support
22	22	--	Bridge Parapet End
23	23	--	Bridge Rail
--	--	23	Bridge Rail (<i>Includes Parapet</i>)
24	24	24	Guardrail Face
25	25	25	Concrete Traffic Barrier
26	26	26	Other Traffic Barrier
27	27	--	Highway/Traffic Sign Post
28	28	--	Overhead Sign Support/Sign
29	29	--	Luminary/Light Support
30	30	--	Utility Pole
--	--	30	Utility Pole/Light Support
31	31	31	Other Post, Other Pole, or Other Support
32	32	32	Culvert
33	33	33	Curb
34	34	34	Ditch

C18 First Harmful Event (continued)**Attribute Codes**

1982- 2003	2004- 2009	2010- Later	
35	35	--	Embankment - Earth
--	--	35	Embankment
36	36	--	Embankment - Rock, Stone, or Concrete
37	37	--	Embankment - Material Type Unknown
38	38	38	Fence
39	39	39	Wall
40	40	40	Fire Hydrant
41	41	41	Shrubbery
42	42	42	Tree (<i>Standing Only</i>)
43	43	43	Other Fixed Object
44	--	--	Pavement Surface Irregularity (<i>1993 Only</i>)
--	44	--	Pavement Surface Irregularity
--	--	44	Pavement Surface Irregularity (<i>Ruts, Potholes, Grates, etc.</i>)
45	--	--	Transport Device Used as Equipment (<i>1993-2003 Only</i>)
45	45	--	Working Construction, Maintenance or Utility Vehicles
--	--	45	Working Motor Vehicle
46	46	46	Traffic Signal Support
47	47	--	Vehicle Occupant Struck or Run Over by Own Vehicle (<i>Since 1997</i>)
48	48	--	Collision With Snow Bank (<i>Since 1997</i>)
--	--	48	Snow Bank
49	49	49	Ridden Animal or Animal-Drawn Conveyance (<i>Since 1998</i>)
50	50	50	Bridge Overhead Structure
--	51	--	Jackknife
--	--	51	Jackknife (<i>Harmful to This Vehicle</i>)
--	52	52	Guardrail End
--	53	53	Mail Box
--	54	--	Motor Vehicle Struck by Falling/Shifting Cargo or Anything Set in Motion by Another Motor Vehicle in Transport
--	--	54	Motor Vehicle In-Transport Strikes or is Struck by Cargo, Persons or Objects Set-in-Motion from/by Another Motor Vehicle In-Transport
--	55	--	Other Not in-Transport Motor Vehicle (<i>2005-2007 Only</i>)
--	55	55	Motor Vehicle in Motion Outside the Trafficway (<i>Since 2008</i>)
--	57	57	Cable Barrier (<i>Since 2008</i>)
--	--	58	Ground
--	--	59	Traffic Sign Support
--	60	--	Cargo/Equipment Loss or Shift
--	61	--	Equipment Failure (<i>Blown Tire, Brake Failure, etc.</i>)
--	62	--	Separation of Units
--	63	--	Ran Off Road - Right
--	64	--	Ran Off Road - Left
--	65	--	Cross Median/Centerline
--	66	--	Downhill Runaway
--	67	--	Vehicle Went Airborne

C18 First Harmful Event *(continued)*

Attribute Codes

1982- 2003	2004- 2009	2010- Later	
--	--	72	Cargo/Equipment Loss or Shift (<i>Harmful to This Vehicle</i>)
--	--	98	Not Reported
99	99	99	Unknown

C19 Manner of Collision

Definition: This element identifies the orientation of two motor vehicles in-transport when they are involved in the First Harmful Event of a collision crash. If the First Harmful Event is not a collision between two motor vehicles in-transport it is classified as such.

Additional Information: In the original files, from 1975 to 1977 sideswipe was coded as 5 but has since been changed to 7. These years are not consistent with the documentation of the time.

SAS Name: **PMAN_COLL**

Attribute Codes

1975- 1977	1978- 2001	
0	0	Not Collision With Motor Vehicle in Transport
1	1	Rear-End
2	2	Head-On
3	3	Rear-to-Rear
4	4	Angle
--	5	Sideswipe, Same Direction
--	6	Sideswipe, Opposite Direction
7	--	Sideswipe (<i>May Either Be Same or Opposite Direction</i>)
9	9	Unknown

Attribute Codes

2002- 2009	2010- Later	
00	00	Not Collision with Motor Vehicle in Transport (<i>Not Necessarily in Transport for 2005-2009</i>)
01	01	Front-to-Rear
02	02	Front-to-Front
03	--	Angle - Front-to-Side, Same Direction
04	--	Angle - Front-to-Side, Opposite Direction
05	--	Angle - Front-to-Side, Right Angle (<i>Includes Broadside</i>)
06	--	Angle - Front-to-Side/Angle-Direction Not Specified
--	06	Angle
07	07	Sideswipe - Same Direction
08	08	Sideswipe - Opposite Direction
09	09	Rear-to-Side
10	10	Rear-to-Rear
11	11	Other (<i>End-Swipes and Others</i>)
--	98	Not Reported
99	99	Unknown

V5 Unit Type

Definition: This element identifies the type of unit that applies to this motor vehicle at the time it became an involved vehicle in the crash and was reported as a unit on the Police Accident Report (PAR).

Additional Information:

SAS Name: PTYPE

Attribute Codes

2005- 2007	2008- Later	
1	--	Motor Vehicle in Transport
--	1	Motor Vehicle in Transport (<i>Inside or Outside the Trafficway</i>)
2	2	Motor Vehicle Not in Transport Within the Trafficway
3	3	Motor Vehicle Not in Transport Outside the Trafficway
4	4	Working Motor Vehicle (<i>Highway Construction, Maintenance, Utility Only</i>)

V6 Hit and Run

Definition: This element indicates whether the vehicle was a contact vehicle in the crash that did not stop to render aid (this can include drivers who flee the scene on foot).

Additional Information: This element has been removed from Accident file since 2009.

From 1975 to 1981 if no information was known about the Hit-and-Run vehicle and/or driver, the vehicle form and/or driver form were not filled out and were not counted as unknown. Starting in 1982 both a vehicle and a driver form were filled out and the data were identified as unknown. This is why, for example, there were approximately only 20 to 40 drivers with unknown sex listed in the FARS data set from 1975 to 1981 and 700 to 1,000 drivers with unknown sex from 1982 on.

SAS Name: PHIT_RUN

Attribute Codes

1975- 1976	1977- 1981	1982- 2008	2009	2010- Later	
0	--	--	--	--	Not Applicable
--	0	0	0	0	No / No Hit-and-Run
1	1	--	--	--	With Motor Vehicle
--	--	1	--	--	Hit Motor Vehicle in Transport
--	--	--	1	1	Yes
2	--	--	--	--	With Non-Occupant
--	2	--	--	--	Hit Non-Motorist
--	--	2	--	--	Hit Pedestrian or Non-Motorist
--	3	--	--	--	Left Scene
--	--	3	--	--	Hit Parked Vehicle (<i>Working Vehicle, Since 2004</i>) or Object
--	--	4	--	--	Occupant Is Struck by or Fell From Own Hit-and-Run Vehicle (<i>2002 Only</i>)
--	--	4	--	--	Driver Leaves Scene after Non-Collision Event (<i>Since 2004</i>)
--	--	5	--	--	Driver/Occupant Leaves Scene after a Non-Collision Event (<i>2003 Only</i>)
--	--	5	--	--	Other Involved Person, not a driver, left Scene (<i>2005-2006</i>)
--	--	5	--	--	Hit-and-Run, Other Involved Person Left Scene (<i>Since 2007</i>)
--	--	--	--	8	Not Reported
--	--	--	9	9	Unknown

V7 Registration State

Definition: This element identifies the state in which this vehicle was registered.

Additional Information: For multiple state registrations prior to 1997 the value is 94. In 1997, values 93 and 94 were combined into 93. After 1997, the value for multiple state registrations is 93.

SAS Name: **PREG_STATE**

Attribute Codes**1975-Later**

01 Alabama	30 Montana
02 Alaska	31 Nebraska
03 American Samoa	32 Nevada
04 Arizona	33 New Hampshire
05 Arkansas	34 New Jersey
06 California	35 New Mexico
08 Colorado	36 New York
09 Connecticut	37 North Carolina
10 Delaware	38 North Dakota
11 District of Columbia	39 Ohio
12 Florida	40 Oklahoma
13 Georgia	41 Oregon
14 Guam	42 Pennsylvania
15 Hawaii	43 Puerto Rico
16 Idaho	44 Rhode Island
17 Illinois	45 South Carolina
18 Indiana	46 South Dakota
19 Iowa	47 Tennessee
20 Kansas	48 Texas
21 Kentucky	49 Utah
22 Louisiana	50 Vermont
23 Maine	51 Virginia
24 Maryland	52 Virgin Islands (<i>Since 2004</i>)
25 Massachusetts	53 Washington
26 Michigan	54 West Virginia
27 Minnesota	55 Wisconsin
28 Mississippi	56 Wyoming
29 Missouri	

V7 Registration State (continued)

Attribute Codes

1975- 2007	2008- 2009	2010- Later	
--	--	00	Not Applicable
--	--	91	Not Reported
92	92	92	No Registration
93	93	93	Multiple State Registrations
94	--	--	Multiple State Registrations - Out-of-State
--	94	94	U.S. Government Tags (<i>Includes Military</i>)
95	--	--	U.S. Government Tags
--	95	95	Canada
96	--	--	Military Vehicle
--	96	96	Mexico
97	--	--	Foreign Country
--	97	97	Other Foreign Country
98	--	--	Other Registration
--	98	98	Other Registration (<i>Includes Native American Indian Nations</i>)
99	99	99	Unknown

V8 Registered Vehicle Owner

Definition: This element indicates the type of registered owner of the vehicle.

Additional Information:

SAS Name: POWNER

Attribute Codes

<i>1991- 2007</i>	<i>2008- Later</i>	
0	0	Not Applicable, Vehicle Not Registered
1	1	Driver (<i>of This Vehicle</i>) Was Registered Owner
2	2	Driver (<i>of This Vehicle</i>) Not Registered Owner (<i>Other Private Owner</i>)
3	3	Vehicle Registered as Business/Company/Government Vehicle
4	4	Vehicle Registered as Rental Vehicle
5	5	Vehicle Was Stolen (<i>Reported By Police</i>)
6	--	Driverless Vehicle
--	6	Driverless/Motor Vehicle Parked/Stopped Off Roadway
9	9	Unknown

V9 Vehicle Make

Definition: This element identifies the make (manufacturer) of this vehicle.

Additional Information: For 1986 and earlier data, one may have to refer to the first several values, 01-09, with a single digit rather than a double digit with a leading "0" zero, e.g., 6 for Chrysler rather than 06 for Chrysler. This may be system-dependent.

SAS Name: **PMAKE**

Attribute Codes**1975-1990**

01	American Motors
02	Jeep
03	AM General
06	Chrysler
07	Dodge
08	Imperial
09	Plymouth
10	Eagle (<i>Not Before 1988</i>)
12	Ford
13	Lincoln
14	Mercury
18	Buick
19	Cadillac
20	Chevrolet
21	Oldsmobile
22	Pontiac
23	GMC
29	Other Domestic
30	Volkswagen
31	Alfa Romeo
32	Audi
33	Austin-Healey
35	Datsun
36	Fiat
37	Honda
38	Isuzu
39	Jaguar
40	Lancia
41	Mazda
42	Mercedes-Benz
43	MG
44	Peugeot
45	Porsche
46	Renault
47	Saab
48	Subaru

V9 Vehicle Make (continued)

Attribute Codes**1975-1990**

- 49 Toyota
- 50 Triumph
- 51 Volvo
- 52 Mitsubishi (*Not Before 1982*)
- 53 Suzuki (*Not Before 1987*)
- 57 Lexus (*Not Before 1988*)
- 58 Infiniti (*Not Before 1988*)
- 59 Other Imports
- 60 BSA
- 61 Ducati
- 62 Harley-Davidson
- 63 Kawasaki
- 64 Moto Guzzi
- 65 Norton
- 67 Yamaha
- 69 Other Motor Cycle
- 70 Moped
- 80 Brockway
- 81 Diamond Reo
- 82 Freightliner
- 83 FWD
- 84 International Harvester
- 85 Kenworth
- 86 Mack
- 87 Peterbilt
- 88 White
- 95 Other Truck/Bus
- 98 Other Make
- 99 Unknown Make

1991-Later

- 01 American Motors
- 02 Jeep/Kaiser-Jeep/Willys Jeep
- 03 AM General
- 06 Chrysler
- 07 Dodge
- 08 Imperial
- 09 Plymouth
- 10 Eagle
- 12 Ford
- 13 Lincoln
- 14 Mercury
- 18 Buick/Opel
- 19 Cadillac

V9 Vehicle Make (continued)

Attribute Codes**1991-Later**

20	Chevrolet
21	Oldsmobile
22	Pontiac
23	GMC
24	Saturn
25	Grumman
29	Other Domestic
	<i>Avanti</i>
	<i>Checker</i>
	<i>DeSoto</i>
	<i>Excalibur</i>
	<i>Hudson</i>
	<i>Packard</i>
	<i>Panoz</i>
	<i>Saleen</i>
	<i>Studebaker</i>
	<i>Stutz</i>
30	Volkswagen
31	Alfa Romeo
32	Audi
33	Austin/Austin Healey
34	BMW
35	Datsun/Nissan
36	Fiat
37	Honda
38	Isuzu
39	Jaguar
40	Lancia
41	Mazda
42	Mercedes-Benz
43	MG
44	Peugeot
45	Porsche
46	Renault
47	Saab
48	Subaru
49	Toyota
50	Triumph
51	Volvo
52	Mitsubishi
53	Suzuki
54	Acura
55	Hyundai
56	Merkur

V9 Vehicle Make (continued)

Attribute Codes**1991-Later**

57	Yugo
58	Infiniti
59	Lexus
60	Daihatsu
61	Sterling
62	Land Rover
63	KIA
64	Daewoo
65	Smart (<i>Since 2010</i>)
69	Other Imports
	<i>Aston Martin</i>
	<i>Bentley</i>
	<i>Bertone</i>
	<i>Bricklin</i>
	<i>Citroen</i>
	<i>DeLorean</i>
	<i>Desta</i>
	<i>Ferrari</i>
	<i>Gazelle</i>
	<i>Hillman</i>
	<i>Jensen</i>
	<i>Lada</i>
	<i>Lamborghini</i>
	<i>Lotus</i>
	<i>Maserati</i>
	<i>Maybach</i>
	<i>Mini Copper</i>
	<i>Morgan</i>
	<i>Morris</i>
	<i>Reliant (British)</i>
	<i>Rolls-Royce</i>
	<i>Simca</i>
	<i>Singer</i>
	<i>Spyker</i>
	<i>Sunbeam</i>
	<i>TVR</i>
70	BSA
71	Ducati
72	Harley-Davidson
73	Kawasaki
74	Moto Guzzi
75	Norton
76	Yamaha
77	Victory

V9 Vehicle Make (continued)

Attribute Codes**1991-Later**

- 78 Other Make Moped (*Since 2010*)
- 79 Other Make Motored Cycle (*Since 2010*)
- 80 Brockway
- 81 Diamond Reo/Reo
- 82 Freightliner
- 83 FWD
- 84 International Harvester/Navistar
- 85 Kenworth
- 86 Mack
- 87 Peterbilt
- 88 Iveco/Magirus
- 89 White/Autocar, White/GMC
- 90 Bluebird
- 91 Eagle Coach
- 92 Gillig
- 93 MCI
- 94 Thomas Built
- 97 Not Reported (*Since 2010*)
- 98 Other Make
 - Auto-Union-DKW*
 - Carpenter*
 - Collins Bus*
 - DINA*
 - Divco*
 - Hino*
 - Mid Bus*
 - Neoplan*
 - Orion*
 - Oshkosh*
 - Scania*
 - Sterling*
 - UD*
 - Van Hool*
 - Western Star*
- 99 Unknown Make

V10 **Vehicle Model** (*listed with Vehicle Make*)

Definition: This element identifies the model of this vehicle within a given make.

Additional Information:

SAS Name: PMODEL

Attribute Codes

See Appendix A: Vehicle Make/Model Designation

V11 Body Type

Definition: This element identifies a classification of this vehicle based on its general body configuration, size, shape, doors, etc.

Additional Information:

1975-1981: Within the yearly NHTSA report *Fatal Accident Reporting System*, the term "Light Trucks" includes Vans.

The body type data do not track with the original documentation. For example, the documentation states that BODY_TYP EQ 7 is for utility vehicles. However, when the files are examined one sees that BODY_TYP EQ 43 is the value that will provide the desired result. The files have been modified to make the early years for this variable compatible with 1981.

Note: Utility vehicles are also part of the light truck category

Note: BODY_TYP 40, large limousines, are not included as part of Passenger Cars or Passenger Vehicles.

1982-1990: Within the yearly NHTSA report *Fatal Accident Report System*, the term "Light Truck" includes Vans. Utility vehicles are also part of the light-truck category.

Note: BODY_TYP 13, large limousines and BODY_TYP 14, three-wheel automobiles or automobile derivatives, are not included as part of Passenger Cars or Passenger Vehicles.

Note: A single-unit truck that tows another vehicle, or a bobtail by itself, is considered a combination truck.

1991-Later: Within the yearly NHTSA publication *Traffic Safety Facts*, the term "Light Trucks" includes Vans.

Note: BODY_TYP 12, large limousines and BODY_TYP 13, three-wheel automobiles or automobile derivatives, are not included as part of Passenger Cars or Passenger Vehicles.

When defining School Buses 1993 and later be sure to include the new body type 24 (van-based school bus). However, body type 24 is not part of Buses.

When defining Transit Buses 1993 and later be sure to include the new body type 25 (van-based transit bus). However, body type 25 is not part of Buses.

Note: A single-unit truck that tows another vehicle, or a bobtail, is considered a combination truck.

V11 Body Type (continued)

SAS Name: PBODYTYP**Attribute Codes****1975-1981**

01	Convertible
02	2-Door Sedan HT/Coupe
03	4-Door Sedan HT
04	Hatchback
05	Car-Pickup Body
06	Station Wagon
07	On/Off Road Vehicle – Jeep CJ-S, Bronco, Blazer, Scout, etc. (1975-1979)
08	Other Auto
09	Unknown Auto Type
15	Motorcycle
16	Moped
17	Other Cycle
18	Unknown Cycle
25	School Bus
26	Cross-County
27	Transit Bus
28	Other Bus
29	Unknown Bus
35	Snowmobile
36	Farm Equipment
37	Dune/Swamp Buggy
38	Construction Equipment
39	Ambulance/Hearse Type
40	Large Limousine
41	Camper/Motorhome
42	Fire Truck
43	On/Off-Road Vehicle – Jeep CJ-S, Bronco, Blazer, Scout, etc. (1980-1981)
44	Other Special Vehicle
45	Ambulance EMS
50	Pickup
51	Van
52	Truck-Based Station Wagon
53	Straight Truck, Low GVW
54	Straight Truck, Medium GVW
55	Straight Truck, High GVW
56	Straight Truck, Unknown GVW
57	Two-Unit Truck
58	Multi-Unit Truck
59	Truck-Tractor
60	Unknown Type Truck
99	Unknown

V11 Body Type (continued)

Attribute Codes**1982-1990**

01	Convertible
02	2-Door Sedan/Ht/Coupe
03	3-Door/2-Door Hatchback
04	4-Door Sedan/Ht
05	5-Door/4-Door Hatchback
06	Station Wagon
07	Hatchback/Number of Doors Unknown
08	Other Auto
09	Unknown Auto Type
10	Auto Pickup
11	Auto Panel
12	Short Utility/Not Truck-Based
13	Large Limousine
14	3-Wheel Vehicle Unknown Body Type
20	Motorcycle
21	Moped
27	3-Wheel Motorcycle Or Moped
28	Other Cycle
29	Unknown Cycle
30	School Bus
31	Cross-Country/Intercity
32	Transit Bus
38	Other Bus
39	Unknown Bus
40	Van
41	Van Commercial Cutaway
42	Van Motorhome
48	Other Van Type
49	Unknown Van Type
50	Pickup
51	Pickup W/Slide-In Camper
52	Pickup-Based Motorhome
53	Cab Chassis Based
54	Truck-Based Panel
55	Truck-Based Sw
56	Truck-Based Utility
58	Other Light Conventional Truck
59	Unknown Light Convent Truck
67	Utility, Base Body Unknown
69	Unknown Light Truck

V11 Body Type (continued)**Attribute Codes****1982-1990**

70	Straight Truck, Low GVW
71	Straight Truck, Medium GVW
72	Straight Truck, High GVW
73	Medium/Heavy Truck Motorhome
74	Truck/Tractor
75	Unknown Medium Truck
76	Unknown Heavy Truck
77	Camper/Motorhome
78	Single Unit Straight Truck GVW Unknown
79	Unknown Truck Type
80	Snowmobile
81	Farm Equipment/Not Trucks
82	ATV, Dune/Swamp Buggy
83	Construction Equipment/Not Trucks
88	Other
89	Unknown Other Vehicle
90	3-Wheel Vehicle Unknown Body Type
99	Unknown Body Type

**1991-2009 2010-
2009 Later**

01	01	Convertible (<i>Excludes Sunroof, T-Bar</i>)
02	02	2-Door Sedan/Hardtop/Coupe
03	03	3-Door/2-Door Hatchback
04	04	4-Door Sedan/Hardtop
05	05	5-Door/4-Door Hatchback
06	06	Station Wagon (<i>Excluding Van and Truck-Based</i>)
07	07	Hatchback, Number of Doors Unknown
08	--	Other Auto (<i>1991-1993 only</i>)
08	08	Sedan/Hardtop, Number of Doors Unknown (<i>Since 1994</i>)
09	--	Unknown Auto Type (<i>1991-1993 Only</i>)
09	09	Other or Unknown Automobile Type (<i>Since 1994</i>)
10	10	Auto-Based Pickup
11	11	Auto-Based Panel (<i>Cargo Station Wagon, Auto-Based Ambulance or Hearse</i>)
12	12	Large Limousine - More Than Four Side Doors or Stretch Chassis
13	13	Three-Wheel Automobile or Automobile Derivative
14	14	Compact Utility (<i>ANSI D-16 Utility Vehicle Categories "Small" and "Midsize"</i>)
15	15	Large Utility (<i>ANSI D-16 Utility Vehicle Categories "Full Size" and "Large"</i>)
16	16	Utility Station Wagon
--	17	3-Door Coupe
19	19	Utility Unknown Body

V11 Body Type *(continued)*

Attribute Codes

1991- 2009	2010- Later	
20	20	Minivan
21	21	Large Van – Includes Van-Based Buses
22	22	Step Van or Walk-In Van
23	--	Van Motorhome <i>(Deleted in 2003 and Later)</i>
24	--	Van-Based School Bus <i>(1993-2002 Only)</i>
25	--	Van-Based Transit Bus <i>(1993-2002 Only)</i>
28	28	Other Van Type <i>(Hi-Cube Van)</i>
29	29	Unknown Van Type
30	30	Compact Pickup <i>(Gross Vehicle Weight, GVWR, < 4,500 lbs)</i>
31	31	Standard Pickup <i>(4,500 lbs < GVWR < 10,000 lbs)</i>
32	32	Pickup with Slide-In Camper
33	33	Convertible Pickup
39	39	Unknown <i>(Pickup Style)</i> Light Conventional Truck Type
40	40	Cab Chassis-Based <i>(Includes Light Stake, Light Dump, Light Tow, Rescue Vehicles)</i>
41	41	Truck-Based Panel
42	42	Light-Truck-Based Motorhome <i>(Chassis Mounted)</i>
45	45	Other Light Conventional Truck Type <i>(Includes Stretched Suburban Limousine)</i>
48	48	Unknown Light-Truck Type <i>(Not a Pickup)</i>
49	49	Unknown Light-Vehicle Type <i>(Automobile, Utility Vehicle, Van or Light Truck)</i>
50	50	School Bus
51	51	Cross-Country/Intercity Bus <i>(i.e., Greyhound)</i>
52	52	Transit Bus <i>(City Bus)</i>
58	58	Other Bus Type
59	59	Unknown Bus Type
60	60	Step Van
61	61	Single-Unit Straight Truck <i>(10,000 lbs < GVWR < or = 19,500 lbs)</i>
62	62	Single-Unit Straight Truck <i>(19,500 lbs < GVWR < or = 26,000 lbs)</i>
63	63	Single-Unit Straight Truck <i>(GVWR > 26,000 lbs)</i>
64	64	Single-Unit Straight Truck <i>(GVWR unknown)</i>
65	65	Medium/Heavy Truck-Based Motorhome
66	66	Truck/Tractor (Cab Only, or with Any Number of Trailing Units: Any Weight)
67	67	Medium/Heavy Pickup <i>(GVWR > 10,000 lbs, Since 2001)</i>
71	71	Unknown if Single-Unit or Combination-Unit Medium Truck <i>(10,000 lbs < GVWR < 26,000 lbs)</i>
72	72	Unknown if Single-Unit or Combination-Unit Heavy Truck <i>(GVWR > 26,000 lbs.)</i>
73	73	Camper or Motorhome, Unknown Truck Type
78	78	Unknown Medium/Heavy Truck Type
79	79	Unknown Truck Type

V11 Body Type (continued)

Attribute Codes

1991- 2009	2010- Later	
80	80	Motorcycle
81	81	Moped (<i>Motorized Bicycle</i>)
82	82	Three-Wheel Motorcycle/Moped- Not All-Terrain Vehicle
83	83	Off-Road Motorcycle (<i>2-Wheel, Since 1993</i>)
88	--	Other Motored Cycle Type (<i>Mini-Bikes, Motor Scooters, 1991-2007</i>)
88	88	Other Motored Cycle Type (<i>Mini-Bikes, Motor Scooters, Pocket Motorcycles, Pocket Bikes, Since 2008</i>)
89	89	Unknown Motored Cycle Type
90	90	ATV (<i>All-Terrain Vehicle; Includes 3 or 4 Wheels</i>)
91	91	Snowmobile
92	92	Farm Equipment Other Than Trucks
93	93	Construction Equipment Other Than Trucks (<i>Includes Graders</i>)
94	94	Motorized Wheel Chair (<i>Since 1997</i>)
97	97	Other Vehicle Type (<i>Includes Go-Cart, Fork-Lift, City Street Sweeper, Dune/Swamp Buggy, Golf Cart</i>)
--	98	Not Reported
99	99	Unknown Body Type

More Information on [Vehicle \(Body Type\) Classification](#)

V12 Vehicle Model Year

Definition: This element identifies the manufacturer's model year of this vehicle.

Additional Information: Prior to 1988, a vehicle manufactured as a 1985 model is coded as 85.

SAS Name: PMODEL_{YR} 2010-*Later*

Attribute Codes

2010-

Later

0000-9997 Actual year of vehicle manufacture

Not Reported

Unknown

V13 Vehicle Identification Number (VIN)

Definition: This element records the vehicle identification number (VIN) of this vehicle.

Additional Information: The first [12 (1994 and later)] [10 (1975-1993)] characters of the vehicle identification number (VIN). The vehicle manufacturers use the VIN to describe certain characteristics of a vehicle and to assign a serial number to the vehicle.

VINA is a software program, maintained by R. L. Polk & Co. that deciphers the VIN for 1966 and newer vehicles that are within the scope of the program. In FARS, the VINA program uses analyst-coded vehicle make, model year and the VIN as input values and returns decoded values for automobiles, trucks, and motorcycles. Vehicle type, determined by the analyst-coded body type, is also used as input to facilitate the program processing. Many variables decoded from the VIN have "VIN" as the first part of their names. Some of the results from the VINA program are used as edit checks for these data.

Starting in 1981, the Vehicle Identification Numbers were required to conform to an international standard. Some of the highlights of those standards appear in the following pages. For vehicles built prior to 1981 one may consult the National Automobile Theft Bureau's publication Passenger Vehicle Identification Manual for the year in question. The VINA program developed by R. L. Polk & Co. is capable of decoding the VIN for model years 1961 and later.

SAS Name: **PVIN**

Attribute Codes

1975- 1993	1994- 2008	
xxxxxxxxxx	xxxxxxxxxxxx	First Characters of the VIN

2010- Later	
000000000000	No VIN Required
xxxxxxxxxxxxxx	Actual VIN
888888888888	Not Reported
999999999999	Unknown

More Information on [Vehicle Identification Number \(VIN\)](#)

V14 Vehicle Trailing

Definition: This element indicates whether this vehicle had any attached trailing units or was towing another motor vehicle.

Additional Information: Note that the number of unknowns is 0 until 1982. From 1982 to 1984 the number of unknowns is approximately 2,500 per year. Starting in 1985 the number of unknowns falls to about 300 per year.

This variable not only applies to tractor trailers, but also to boats, cars, and U-Haul-type vehicles that are towed with a trailer hitch. Vehicles pulled by a rope or chain are not counted as towed vehicles.

SAS Name: PTRAILER

Attribute Codes

<i>1975- 1981</i>	<i>1982</i>	<i>1983- 2003</i>	<i>2004- 2008</i>	<i>2009- Later</i>	
0	0	0	0	0	No Trailing Unit
1	--	--	--	--	Yes
--	1	1	1	1	Yes, One Trailing Unit
--	--	2	2	2	Yes, Two Trailing Units
--	--	3	3	3	Yes, Three or More Trailing Units
--	4	4	4	4	Yes, Number of Trailing Units Unknown
--	5	--	--	--	Yes, Two or More Trailing Units
--	--	--	5	--	Vehicle Towing another Motor Vehicle
--	--	--	--	5	Vehicle Towing another Motor Vehicle – Fixed Linkage
--	--	--	--	6	Vehicle Towing another Motor Vehicle – Non-Fixed Linkage
--	--	9	9	9	Unknown

V16 Motor Carrier Identification Number

Definition: This element records the issuing authority and motor carrier identification number if applicable to this vehicle.

Additional Information: This is a derivate variable. It is the combination of two variables MCARR_I1 and MCARR_I2. This variable is only applicable for the following vehicles:

- Medium/Heavy Trucks: vehicles with two axles/six tires and/or gross weight greater than 10,000 pounds.
- Buses with 16 or more seats (including the driver)
- Trucks and Vans of any size carrying hazardous cargo.
- Light commercial trucks pulling a trailer with gross combination weight rating (GCWR) greater than 10,000 pounds.

SAS Name: **PMCARR_ID**

Attribute Codes**1998-Later**

xxxxxxxxxx 11-digit combination of MCARR_I1 followed by MCARR_I2

V16A MCID Issuing Authority

Definition: This element records the issuing authority if applicable to this vehicle.

Additional Information: This variable is only applicable for the following vehicles:

- Medium/Heavy Trucks: vehicles with two axles/six tires and/or gross weight greater than 10,000 pounds.
- Buses with 16 or more seats (including the driver)
- Trucks and Vans of any size carrying hazardous cargo.
- Light commercial trucks pulling a trailer with gross combination weight rating (GCWR) greater than 10,000 pounds.

SAS Name: **PMCARR_I1**

Attribute Codes

1998- 2006	2007- 2009	2010- Later	
00	00	00	Not Applicable
01-56	01-56	01-56	FARS State Code
57	57	57	US DOT
58	--	--	ICC
--	58	58	MC/MX (<i>ICC</i>)
--	--	77	Not Reported
88	88	88	None
95	95	95	Canada
96	96	96	Mexico
99	99	99	Unknown

V16B MCID Identification Number

Definition: This element records the motor carrier identification number if applicable to this vehicle.

Additional Information: This variable is only applicable for the following vehicles:

- Medium/Heavy Trucks: vehicles with two axles/six tires and/or gross weight greater than 10,000 pounds.
- Buses with 16 or more seats (including the driver)
- Trucks and Vans of any size carrying hazardous cargo.
- Light commercial trucks pulling a trailer with gross combination weight rating (GCWR) greater than 10,000 pounds.

SAS Name: **PMCARR_I2**

Attribute Codes**1998-Later**

xxxxxxxx	Actual 9-Digit Number
00000000	Not Applicable
77777777	Not Reported
88888888	None
99999999	Unknown

V17 Gross Vehicle Weight Rating/GCWR

Definition: This element identifies the gross vehicle weight rating of this vehicle when applicable.

Additional Information: The Gross Vehicle Weight Rating (GVWR) or Gross Combination Weight Rating (GCWR) is a value specified by the manufacturer for a single-unit truck, truck tractor, or trailer. In the absence of a gross vehicle weight rating, an estimate of the gross weight of a fully loaded unit can be substituted.

In 2000 the GVWR was the sum of the weight of the power unit and its trailers. Since 2001 this element is the gross vehicle weight of the Power Unit only. The weight of trailers is not added.

SAS Name: **PGVWR**

Attribute Codes

2000- 2009	2010- Later	
0	0	Not Applicable
1	1	10,000 lbs or Less
2	2	10,001 lbs - 26,000 lbs
3	3	26,001 lbs or More
--	8	Not Reported
9	9	Unknown

V18 Vehicle Configuration

Definition: This element identifies the general configuration of this vehicle when applicable.

Additional Information:

SAS Name: PV_CONFIG

Attribute Codes

1991-1994	1995-2000	2001-2009	2010-Later	
0	0	--	--	Not Applicable, Not a Medium/Heavy Truck or Bus
--	--	00	--	Not Applicable, Not a Medium/Heavy Truck or Bus or Vehicle Displaying a Hazardous Material Placard
--	--	--	00	Not Applicable
1	1	01	--	Single-Unit Truck (2 axles, 6 tires)
--	--	--	01	Single-Unit Truck (2 axles and GVWR more than 10,000 lbs.)
2	2	02	02	Single-Unit Truck (3 or More axles)
--	3	03	--	Single-Unit Truck (Unknown Number of Axles, Tires)
3	4	04	--	Truck/Trailer(s)
--	--	--	04	Truck Pulling Trailer(s)
4	5	05	05	Truck Tractor (Bobtail, i.e., Tractor Only, No Trailer)
5	6	--	--	Truck Tractor/Semi-Trailer
--	--	06	--	Tractor/Semi-Trailer (One Trailer)
--	--	--	06	Tractor/Semi-Trailer
--	--	07	--	Tractor/Doubles (Two Trailers)
--	--	--	07	Truck Tractor/Double
--	--	08	--	Tractor/Triples (Three Trailers)
--	--	--	08	Truck Tractor/Triple
--	--	--	10	Vehicle 10,000 lbs or Less Placarded for Hazardous Materials
6	7	19	--	Medium/Heavy Trucks, Cannot Classify
--	--	--	19	Truck More than 10,000 lbs., Cannot Classify
7	8	--	--	Bus
--	--	20	--	Bus (Seats for 9-15 Occupants, Including Driver)
--	--	--	20	Bus/Large Van (Seats for 9-15 Occupants, Including Driver)
--	--	21	--	Bus (Seats for More Than 15 People, Including Driver, 2001-2006)
--	--	21	--	Bus (Seats for 16 or More People, Including Driver, Since 2007-2009)
--	--	--	21	Bus (Seats for More Than 15 Occupants, Including Driver, 2010 and Later)
--	--	70	--	Light Truck (Van, Mini-Van, Panel, Pickup, Sport Utility Vehicle Displaying a Hazardous Material Placard)
--	--	80	--	Passenger Car (Only When Displaying a Hazardous Material Placard)
--	--	--	98	Not Reported
9	--	--	99	Unknown
--	9	99	--	Unknown if Light or Medium/Heavy Truck/Bus

V19 Cargo Body Type

Definition: This element identifies the primary cargo carrying capability of this vehicle when applicable.

Additional Information:

SAS Name: PCARGTYP

Attribute Codes

1991- 1994	1995- 2000	2001- 2008	2009	2010- Later	
00	00	--	--	--	Not Applicable Not a Truck or Bus
--	--	00	--	--	Not Applicable, Not a Medium/Heavy Truck or Bus
--	--	--	00	00	Not Applicable
01	01	01	01	01	Van/Enclosed Box
02	02	02	02	02	Cargo Tank
03	03	03	03	03	Flatbed
04	04	04	04	04	Dump
05	05	05	05	05	Concrete Mixer
06	06	06	06	06	Auto Transporter
07	07	07	07	07	Garbage/Refuse
08	--	--	--	--	Medium/Heavy Truck, Other Body Type
09	08	--	--	--	Bus
--	--	08	08	08	Grain, Chips, Gravel
--	--	09	--	--	Pole
--	--	--	09	09	Pole-Trailer
--	--	10	10	10	Log (<i>Since 2007</i>)
--	--	11	--	--	Intermodal Chassis (<i>2007-2008 Only</i>)
--	--	--	11	11	Intermodal Container Chassis
--	--	12	12	12	Vehicle Towing Another Motor Vehicle (<i>Since 2007</i>)
--	--	20	--	--	Bus (<i>Seats 9-15 People, Including Driver</i>)
--	--	21	--	--	Bus (<i>Seats More than 15 People, Including Driver, 2001-2006 Only</i>)
--	--	21	--	--	Bus (<i>Seats for 16 or More People, Including Driver, 2007-2008 Only</i>)
--	--	--	22	22	Bus
--	--	--	--	28	Not Reported
--	--	96	96	96	No Cargo Body Type
--	97	--	--	--	Medium/Heavy Truck, Other Cargo Body Type
--	--	97	--	--	Medium/Heavy Truck, or Bus, Other Cargo Body Type (<i>Not Elements 01-12, 20-21</i>)
--	--	--	97	97	Other
--	98	--	--	--	Medium/Heavy Truck, Unknown Cargo Body Type
--	--	98	--	--	Medium/Heavy Truck, or Bus, Unknown Cargo Body Type
--	--	--	98	98	Unknown Cargo Body Type

V19 Cargo Body Type (continued)

Attribute Codes

1991- 1994	1995- 2000	2001- 2008	2009	2010- Later	
99	--	--	--	--	Unknown Vehicle Type
--	99	99	--	--	Unknown if Light or Medium/Heavy Truck/Bus (1995-2008)
--	--	--	99	99	Unknown

V20A/HM1 Hazardous Material Involvement

Definition: This element indicates whether the vehicle was carrying hazardous materials.

Additional Information:

SAS Name: PHAZ_INV

2007-Later

- 1 No
- 2 Yes

V20B/HM2 Hazardous Material Placard

Definition: This element indicates the presence of hazardous materials and whether the vehicle displayed a hazardous materials placard.

Additional Information:

SAS Name: PHAZPLAC

2007-Later

- 0 Not Applicable
- 1 No
- 2 Yes
- 8 Not Reported

V20C/HM3 Hazardous Material Identification Number

Definition: This element indicates the 4-digit hazardous material identification number.

Additional Information:

SAS Name: PHAZ_ID

2007-Later

- 0000 Not Applicable
- xxxx Actual 4-Digit Number
- 8888 Not Reported

V20D/HM4 Hazardous Material Class Number

Definition: This element indicates the single-digit hazardous material class number for the vehicle.

Additional Information:

SAS Name: PHAZ_CNO

2007

0	Not Applicable
1-7 or 9	Actual Number
8	Not Reported

2008-Later

00	Not Applicable
01-09	Actual Number (<i>With Leading Zero</i>)
88	Not Reported

V20E/HM5 Release of Hazardous Material from the Cargo Compartment

Definition: This element indicates whether or not any hazardous cargo was released from the cargo tank or compartment.

Additional Information:

SAS Name: PHAZ_REL

2007-Later

0	Not Applicable
1	No
2	Yes
8	Not Reported

V21 Bus Use

Definition: This element describes the common type of bus service this vehicle was being used as at the time of the crash.

Additional Information:

SAS Name: **PBUS_USE**

Attribute Codes

2000-2009

- 0 Not Used as a Bus
- 1 Used as a Public School Bus
- 2 Used as a Private School Bus
- 3 Used as a School Bus, Public or Private Unknown
- 4 Used as a Scheduled Service Bus
- 5 Used as a Tour Bus
- 6 Used as a Commuter Bus
- 7 Used as a Shuttle Bus
- 8 Modified for Personal/Private Use
- 9 Unknown Bus Use

2010-Later

- 00 Not a Bus
- 01 School Bus
- 04 Intercity Bus
- 05 Charter/Tour Bus
- 06 Transit/Commuter Bus
- 07 Shuttle Bus
- 08 Modified for Personal/Private Use
- 98 Not Reported
- 99 Unknown

V22 Special Use

Definition: This element indicates whether, and in what way, the vehicle was being used for a function other than the primary function for that type vehicle at the time of the crash.

Additional Information:

SAS Name: **PSP_USE**

Attribute Codes

1975- 2009	2010- Later	
0	00	No Special Use
1	01	Taxi
2	02	Vehicle Used as School Bus
3	03	Vehicle Used as Other Bus
4	04	Military
5	05	Police
6	06	Ambulance (<i>Since 1980</i>)
7	07	Fire Truck (<i>Since 1982</i>)
8	08	Emergency Services Vehicle (<i>Since 2009</i>)
--	98	Not Reported
9	99	Unknown

V23 Emergency Use

Definition: This element indicates operation of any motor vehicle that is legally authorized by a government authority to respond to emergencies with or without the use of emergency warning equipment, such as a police vehicle, fire truck or ambulance while actually engaged in such response.

Additional Information: This element is applicable only if the vehicle was being used as an emergency vehicle at the time of the crash.

SAS Name: **PEM_USE**

Attribute Codes

1977- 2009	2010- Later	
0	0	No
1	1	Yes
--	8	Not Reported
--	9	Unknown

V25 Underride/Override

Definition: This element indicates this vehicle's involvement in an underride or override during the crash.

Additional Information: Note the striking vehicle, not the vehicle struck, determines the underride/override condition. From 1975 to 1993 both the initial and principal impacts were counted. In the event and only in the event, that the initial or principal impact point was an underride/override were the variable IMPACT1 or IMPACT2 flagged/counted as such. However, all other underrides/overrides were not counted, nor should they have been counted. Impacts were counted, not underrides. Therefore, the variable UNDERIDE was added to the FARS system in 1994.

The variable UNDERIDE, like all FARS variables, is dependent on the data contained in police crash reports. The NASS/CDS system is based on the efforts of professional crash investigators performing detailed analysis of approximately 5,000 crashes a year. An analysis of the 1994-1996 FARS and NASS/CDS data systems and the 1997 Trucks in Fatal Accident file revealed that underrides and overrides are generally not identified on the police crash reports.

SAS Name: **PUNDERIDE**

Attribute Codes**1994-Later**

- 0 No Underride or Override
- WITH MOTOR VEHICLE IN TRANSPORT*
- 1 Underride (*Compartment Intrusion*)
 - 2 Underride (*No Compartment Intrusion*)
 - 3 Underride (*Compartment Intrusion Unknown*)
- WITH MOTOR VEHICLE NOT IN TRANSPORT*
- 4 Underride (*Compartment Intrusion*)
 - 5 Underride (*No Compartment Intrusion*)
 - 6 Underride (*Compartment Intrusion Unknown*)

 - 7 Override, Motor Vehicle in Transport
 - 8 Override, Motor Vehicle Not in Transport
 - 9 Unknown if Underride or Override

V28 Area of Impact- Initial/Most Damaged**V28A Initial Damage Area**

Definition: This element identifies the area on this vehicle that produced the first instance of injury to non-motorists or occupants of this vehicle, or that resulted from the first instance of damage to other property or to this vehicle.

Additional Information: The striking vehicle, not the vehicle struck, determines the underride/override condition. After the crash, in the case of an override or underride one vehicle is over the other. If the striking vehicle is over the other, then the crash is an override. If the striking vehicle is under the other, the crash is an underride. See Vehicle Role SAS Name: IMPACTS.

See the note on the page about using and interpreting the variable UNDERIDE

SAS Name: PIMPACT1

Attribute Codes

1975- 1993	1994- 2009	2010- Later	
00	00	00	Non-Collision
01-12	01-12	01-12	Clock points
13	13	13	Top
14	14	14	Undercarriage
15	--	--	Underride (1980-1993 only)
16	--	--	Override (1982-1993 only)
--	18	--	This Vehicle Set Something in Motion Causing Injury or Damage (Not a Clock Point, since 2004)
--	--	18	Set-in-Motion (Not a Clock Point)
--	--	61	Left
--	--	62	Left-Front Half
--	--	63	Left-Back Half
--	--	81	Right
--	--	82	Right-Front Half
--	--	83	Right-Back Half
--	--	98	Not Reported
99	99	99	Unknown

V28 Area of Impact- Initial/Most Damaged (continued)**V28B Most Damaged Area**

Definition: This element identifies the area on this vehicle that was most damaged during an event it underwent in the crash.

Additional Information: The striking vehicle, not the vehicle struck, determines the under/override condition. After the crash, in the case of an override or under/override one vehicle is over the other. If the striking vehicle is over the other, then the crash is an override. If the striking vehicle is under the other, the crash is an under/override. See Vehicle Role SAS Name: IMPACTS.

See the note on the page about using and interpreting the variable UNDERIDE

SAS Name: **PIMPACT2**

Attribute Codes

1975- 1993	1994- 2009	2010- Later	
00	00	00	Non-Collision
01-12	01-12	01-12	Clock points
13	13	13	Top
14	14	14	Undercarriage
15	--	--	Under/override (1980-1993 Only)
16	--	--	Override (1982-1993 Only)
--	18	--	This Vehicle Set Something in Motion Causing Injury or Damage (Not a Clock Point, Since 2004)
--	--	18	Set-in-Motion (Not a Clock Point)
--	--	61	Left
--	--	62	Left-Front Half
--	--	63	Left-Back Half
--	--	81	Right
--	--	82	Right-Front Half
--	--	83	Right-Back Half
--	--	98	Not Reported
99	99	99	Unknown

More Information on [Impact](#)

V29 Extent of Damage

Definition: This element indicates the amount of damage sustained by this vehicle in this crash as indicated in the case materials based on an operational damage scale.

Additional Information: The element name was “Extent of Deformation” from 1975 to 2008. The element name has been changed to “Extent of Damage” since 2009.

The data on “8 Not Reportable” collected in 1976 are no longer contained in the file. The data for that year are not consistent with the documentation of the time.

SAS Name: PVEH_SEV

Attribute Codes

1975-2008

0	None
2	Other (<i>Minor</i>)
4	Functional (<i>Moderate</i>)
6	Disabling (<i>Severe</i>)
9	Unknown

2009 2010- Later

0	0	No Damage
2	2	Minor Damage
4	4	Functional Damage
6	6	Disabling Damage
--	8	Not Reported
9	9	Unknown

V30 Vehicle Removal

Definition: This element describes the mode by which the vehicle left the scene of the crash.

Additional Information: The element name was “Manner of Leaving Scene” from 1975 to 2008. The element name has been changed to “Vehicle Removal” since 2009.

The early years are not consistent with the documentation of the time.

SAS Name: **PTOWED**

Attribute Codes

1975	1976- 2008	2009	2010- Later	
--	1	1	1	Driven Away
2	2	--	--	Towed Away
--	--	2	2	Towed Due to Disabling Damage
--	3	--	--	Abandoned/Left Scene
--	--	3	3	Towed Not Due to Disabling Damage
4	--	--	--	Not Towed Away
--	--	4	4	Abandoned/Left Scene
--	--	--	8	Not Reported
9	9	--	--	Unknown
--	--	9	9	Unknown if Towed

V32 Most Harmful Event

Definition: This element identifies the event that resulted in the most severe injury or, if no injury, the greatest property damage involving this motor vehicle.

Additional Information: First harmful event applies to the crash. The most harmful event variable M_HARM applies to the vehicle. Harmful events are judgment calls of the FARS analysts based on the data within the police crash report.

Most harmful event applies to the vehicle. This variable has the same values as does HARM_EV but is at the vehicle level rather than the crash level. Therefore different vehicles in a crash will have the same first harmful event but may have different most harmful events. Note in particular, that M_HARM describes a vehicle, not a person. Therefore, one cannot assume that the most harmful event for a vehicle was the cause of any death or injury for any specific individual within the vehicle.

Starting in 2004 the HARM_EV, M_HARM and the sequence of event variables, (SEQ_i, 1 ≤ i ≤ 6) have the same values. The harmful event values were modified to be consistent with the sequence of event variables.

If either first harmful event, HARM_EV, or most harmful event, M_HARM, is used, it is often a good idea to construct a two-way table of harmful events by State and check for consistency. For example, in the 1989 FARS data in the cases where a vehicle fire was identified, that is FIRE_EXP = 1, Virginia coded M_HARM as 02 Fire/Explosion for all cases. In the same year for the crashes where a vehicle fire was identified, that is FIRE_EXP = 1, Connecticut, Delaware, Idaho, Kansas, Mississippi, New Hampshire, Oklahoma, Rhode Island, South Dakota, and Wyoming never coded M_HARM as 02 Fire/Explosion. That is, different states code harmful events differently.

SAS Name: **PM_HARM**

Attribute Codes**1979-1981**

- 01 Overturn
- 02 Fire/Explosion
- 03 Immersion
- 04 Gas Inhalation
- 05 Fell from Vehicle
- 06 Injured in Vehicle
- 07 Other Non-Collision
- 08 Pedestrian
- 09 Pedalcycle
- 10 Railway Train
- 11 Animal
- 12 Motor Vehicle in Transport
- 13 Motor Vehicle in Transport in Other Roadway
- 14 Parked Motor Vehicle

V32 Most Harmful Event (continued)**Attribute Codes****1979-1981**

15	Other Type Non-Motorist
16	Other Object
17	Bridge or Overpass (1975-1978 only)
18	Building
19	Culvert
20	Curb or Wall
21	Divider
22	Embankment
23	Fence
24	Guard Rail
25	Light Support
26	Sign Post
27	Tree/Shrubbery
28	Utility Pole
29	Other Pole/Support
30	Impact Attenuator
31	Other Fixed Object
32	Bridge or Overpass [Passing Under] (1979-1981 only)
33	Bridge or Overpass [Passing Over] (1979-1981 only)
99	Unknown

1982- 2003	2004- 2009	2010- Later
-----------------------	-----------------------	------------------------

01	01	01	Rollover/Overturn
02	02	02	Fire/Explosion
03	03	03	Immersion
04	04	04	Gas Inhalation
05	05	05	Fell/Jumped from Vehicle
06	06	--	Injured in Vehicle
--	--	06	Injured in Vehicle (Non-Collision)
07	07	07	Other Non-Collision
08	08	08	Pedestrian
09	09	--	Pedalcycle
--	--	09	Pedalcyclist
10	10	--	Railway Train
--	--	10	Railway Vehicle
11	11	--	Animal
--	--	11	Live Animal
12	12	--	Motor Vehicle in Transport on Same Roadway
--	--	12	Motor Vehicle in Transport
13	13	--	Motor Vehicle in Transport on Other Roadway
14	14	14	Parked Motor Vehicle

V32 Most Harmful Event (continued)

Attribute Codes

1982- 2003	2004- 2009	2010- Later	
15	--	--	Other Type Non-Motorist
--	15	15	Non-Motorist on Personal Conveyance
16	16	16	Thrown or Falling Object
17	17	17	Boulder
18	18	18	Other Object (<i>Not Fixed</i>)
19	19	19	Building
20	20	20	Impact Attenuator/Crash Cushion
21	21	--	Bridge Pier or Abutment
--	--	21	Bridge Pier or Support
22	22	--	Bridge Parapet End
23	23	--	Bridge Rail
--	--	23	Bridge Rail (<i>Includes Parapet</i>)
24	24	24	Guardrail Face
25	25	25	Concrete Traffic Barrier
26	26	26	Other Traffic Barrier
27	27	--	Highway/Traffic Sign Post
28	28	--	Overhead Sign Support/Sign
29	29	--	Luminary/Light Support
30	30	--	Utility Pole
--	--	30	Utility Pole/Light Support
31	31	31	Other Post, Other Pole, or Other Support
32	32	32	Culvert
33	33	33	Curb
34	34	34	Ditch
35	35	--	Embankment - Earth
--	--	35	Embankment
36	36	--	Embankment - Rock, Stone, or Concrete
37	37	--	Embankment - Material Type Unknown
38	38	38	Fence
39	39	39	Wall
40	40	40	Fire Hydrant
41	41	41	Shrubbery
42	42	42	Tree (<i>Standing Only</i>)
43	43	43	Other Fixed Object
44	--	--	Pavement Surface Irregularity (<i>1993 Only</i>)
--	44	--	Pavement Surface Irregularity
--	--	44	Pavement Surface Irregularity (<i>Ruts, Potholes, Grates, etc.</i>)
45	--	--	Transport Device Used as Equipment (<i>1993-2003 Only</i>)
45	45	--	Working Construction, Maintenance or Utility Vehicles
--	--	45	Working Motor Vehicle
46	46	46	Traffic Signal Support
47	47	--	Vehicle Occupant Struck or Run Over by Own Vehicle (<i>Since 1997</i>)

V32 Most Harmful Event (continued)**Attribute Codes**

1982- 2003	2004- 2009	2010- Later	
48	48	--	Collision With Snow Bank (<i>Since 1997</i>)
--	--	48	Snow Bank
49	49	49	Ridden Animal or Animal-Drawn Conveyance (<i>Since 1998</i>)
50	50	50	Bridge Overhead Structure
--	51	--	Jackknife
--	--	51	Jackknife (<i>Harmful to This Vehicle</i>)
--	52	52	Guardrail End
--	53	53	Mail Box
--	54	--	Motor Vehicle Struck by Falling/Shifting Cargo or Anything Set in Motion by Another Motor Vehicle in Transport
--	--	54	Motor Vehicle In-Transport Strikes or is Struck by Cargo, Persons or Objects Set-in-Motion from/by Another Motor Vehicle In-Transport
--	55	--	Other Not in-Transport Motor Vehicle (<i>2005-2007 Only</i>)
--	55	55	Motor Vehicle in Motion Outside the Trafficway (<i>Since 2008</i>)
--	57	57	Cable Barrier (<i>Since 2008</i>)
--	--	58	Ground
--	--	59	Traffic Sign Support
--	60	--	Cargo/Equipment Loss or Shift
--	61	--	Equipment Failure (<i>Blown Tire, Brake Failure, etc.</i>)
--	62	--	Separation of Units
--	63	--	Ran Off Road - Right
--	64	--	Ran Off Road - Left
--	65	--	Cross Median/Centerline
--	66	--	Downhill Runaway
--	67	--	Vehicle Went Airborne
--	--	72	Cargo/Equipment Loss or Shift (<i>Harmful to This Vehicle</i>)
--	--	98	Not Reported
99	99	99	Unknown

V33 Related Factors - Vehicle Level

Definition: This element identifies factors related to this vehicle expressed by the investigating officer.

Additional Information: There are also crash-level-related factors in the Accident file, CF1, CF2, and CF3 and driver-related factors in the Vehicle file, namely DR_CF1, DR_CF2, DR_CF3 and (DR_CF4 since 1997).

The FARS analyst may have used either of the two variables to code a related factor. One must test both variables to insure that the selected related factor is included.

SAS Name: PVEH_SC1, PVEH_SC2

Attribute Codes

1975- 1981	1982- 2009	2010- Later	
00	00	00	None
01	--	--	Tires and Wheels
--	01	--	Tires (<i>Does Not Include Wheels, See Value 16</i>)
02	02	--	Brake System
03	03	--	Steering System- Tie Rod, Kingpin, Ball Joint, etc.
04	04	--	Suspension- Springs, Shock Absorbers, MacPherson struts, Axle Bearing, Control Arms, etc.
05	05	--	Power Train (<i>Power Train/Engine, Since 2001</i>)- Universal Joint, Drive Shaft, Transmission, etc.
06	06	--	Exhaust System
07	07	--	Headlights
08	08	--	Signal Lights
09	09	--	Other Lights
10	10	--	Horn
11	11	--	Mirrors
12	12	--	Wipers
13	13	--	Driver Seating and Control
14	14	--	Body, Doors, Hood, Other
15	15	--	Trailer Hitch
--	16	--	Wheels
--	17	--	Air Bags (<i>Since 1995</i>)
--	18	--	Other Vehicle Defects
--	19	--	Safety Belts (<i>Since 2002</i>)
--	31	--	Hit-and-Run Vehicle (<i>1982-2008 Only</i>)
--	32	32	Vehicle Registration for Handicapped
--	33	33	Vehicle Being Pushed by Non-Motorist
--	34	--	Vehicle Impact Point- the Result of Something Set in Motion (<i>1998-2003 Only</i>)

V33 Related Factors - Vehicle Level (continued)**Attribute Codes**

1975- 1981	1982- 2009	2010- Later	
--	35	--	Reconstructed Vehicle (1998-2007)
--	35	35	Reconstructed/Altered Vehicle (Since 2008)
--	36	36	Electric/Alternative Fuel Vehicle (Since 1999)
--	37	37	Transporting Children to/from Head Start/Day Care (Since 2000)
--	38	38	Vehicle Went Airborne During Crash (2001-2003)
--	39	39	Highway Construction, Maintenance or Utility Vehicle, In Transport (Inside or Outside Work Zone) (Since 2002)
--	40	40	Highway Incident Response Vehicle (Since 2002)
--	41	41	Police Fire or EMS Vehicle Working at the Scene of an Emergency or Performing Other Traffic Control Activities (Since 2004)
--	42	42	Other Working Vehicle (Not Construction, Maintenance, Utility, Police, Fire, or EMS Vehicle, Since 2004)
--	43	--	Hazardous Materials/Cargo Released From This Vehicle (2005-2006)
--	44	44	Adaptive Equipment (Since 2007)
99	99	99	Unknown

V34 Fire Occurrence

Definition: This element indicates whether a fire in any way related to the crash occurred in this vehicle.

Additional Information: From 1975 to 1979 if an explosion occurred in the vehicle, with or without a fire, this variable would also be set to 1.

SAS Name: **PFIRE**

Attribute Codes

<i>1975- 2007</i>	<i>2008</i>	<i>2009- Later</i>	
0	0	--	No Fire
--	--	0	No or Not Reported
1	1	--	Fire Occurred in This Vehicle during Crash
--	--	1	Yes
--	2	--	Fire Occurred in This Vehicle and Initiated Fire/Explosion in Another Vehicle

V100 Make Model Combined

Definition: This element represents the 5-digit combined codes of the variables MAKE and MODEL.

Additional Information: This variable also appears in the Vehicle data set as MAK_MOD.

SAS Name: PMAK_MOD

Attribute Codes***1975-Later***

See Appendix A: Vehicle Make/Model Designation.

V113 VIN Vehicle Type

Definition: This element identifies the basic vehicle type.

Additional Information:

SAS Name: **PVINTYPE**

Attribute Codes***2010-Later***

P	Passenger Vehicle
T	Truck
M	Motorcycle
U	Unknown

V114 VIN Make

Definition: This element provides the NCIC Standard Make Abbreviation.

Additional Information: See Appendix of the PC VINA User's Manual.

SAS Name: **PVINMAKE**

Attribute Codes***2010-Later***

xxxx 4-Character Make Abbreviation

V115 VIN Model

Definition: The VIN Model, for automobiles, is obtained from the VINA program for automobiles of model year 1966 and later that have verifiable VIN numbers.

Additional Information: If one needs to select cars based on make and model the variable of choice is VINA_MOD rather than MAK_MOD.

This is a CHARACTER variable in UPPER CASE three characters long.

The VINA_MOD is only unique within the vehicle make. That is, different makes of vehicles can have the same VINA_MOD. To ensure that the correct vehicle is selected the variable MAKE must be used in conjunction with VINA_MOD. Both variables, VINA_MOD and MAKE, are in both the Vehicle file and the Person File.

There are two columns headed VINA CODE. For passenger cars, or what Polk calls passenger vehicles, the FARS variable VINA_MOD can be set to either the VINA code for the series name, i.e., the first column, or it can be set to the value of the sub-series name, the last column. Therefore one must search for values in both columns.

For trucks the first column labeled VINA CODE, series name, is the FARS variable SER_TR. When using the variable SER_TR all model names, last column are included. If one wishes to select a specific truck model one uses the FARS variable VINA_MOD set to the value in the last VINA CODE column.

See Appendix of the PC VINA User's Manual.

SAS Name: **PVINA_MOD**

Attribute Codes**1975-Later**

xxx 3-Character Model (Series) Abbreviation

V116 VIN Body Type

Definition: This element is a 2-character representation of the vehicle's body style.

Additional Information: This is a CHARACTER variable in UPPER CASE.

The VINA program decodes these data and partitions vehicles into three classes, passenger vehicles, trucks, and motorcycles.

SAS Name: **PVIN_BT**

Attribute Codes

1982- 2009	2010- Later	
2D	2D	Passenger Vehicle Sedan 2-Door
2F	2F	Passenger Vehicle Formal Hardtop 2-Door
2H	2H	Passenger Vehicle Hatchback 2-Door
2L	2L	Passenger Vehicle Liftback 3-Door
2P	2P	Passenger Vehicle Pillard Hardtop 2-Door
2T	2T	Passenger Vehicle Hardtop 2-Door
2W	2W	Truck 2-Door Wagon/Sport Utility
2W	2W	Passenger Vehicle Wagon 2-Door
--	3B	Truck 3-Door Extended Cab/Chassis
--	3C	Truck 3-Door Extended Cab Pickup
3D	3D	Passenger Vehicle Runabout 3-Door
--	3P	Passenger Vehicle Coupe 3-Door
--	4B	Truck 4-Door Extended Cab/Chassis
--	4C	Truck 4-Door Extended Cab Pickup
4D	4D	Passenger Vehicle Sedan 4-Door
4H	4H	Passenger Vehicle Hatchback 4-Door
4L	4L	Passenger Vehicle Liftback 5-Door
4P	4P	Passenger Vehicle Pillard Hardtop 4-Door
4T	4T	Passenger Vehicle Hardtop 4-Door
4W	4W	Truck 4-Door Wagon/Sport Utility
4W	4W	Passenger Vehicle Wagon 4-Door
5D	5D	Passenger Vehicle Sedan 5-Door
8V	8V	Truck 8-Passenger Sport Van
AC	AC	Truck Auto Carrier
AM	AM	Passenger Vehicle Ambulance
AR	AR	Truck Armored Truck
AT	AT	Motorcycle All-Terrain
BU	BU	Bus
--	C4	Passenger Vehicle Coupe 4-Door
CB	CB	Truck Chassis and Cab
CB	CB	Passenger Vehicle Cab & Chassis (<i>Luv</i>)

V116 VIN Body Type (continued)

Attribute Codes

1982- 2009	2010- Later	
CC	CC	Truck Conventional Cab
CG	CG	Truck Cargo Van
CH	CH	Truck Crew Chassis
CL	CL	Truck Club Chassis
CM	CM	Truck Concrete or Transit Mixer
CP	CP	Truck Crew Pickup
CP	CP	Passenger Vehicle Coupe
CR	CR	Truck Crane
CS	CS	Truck Super Cab/Chassis Pickup
CU	CU	Truck Custom Pickup
CV	CV	Truck Convertible (<i>Jeep Commando, Suzuki Samurai, Dodge Dakota</i>)
CV	CV	Passenger Vehicle Convertible
CY	CY	Truck Cargo Cutaway
DP	DP	Truck Dump
DS	DS	Truck Tractor Truck (<i>Diesel</i>)
EC	EC	Truck Extended Cargo Van
EN	EN	Motorcycle Enduro
ES	ES	Truck Extended Sport Van
EV	EV	Truck Extended Van
EW	EW	Truck Extended Window Van
FB	FB	Truck Flat-bed or Platform
FC	FC	Truck Forward Control
FT	FT	Truck Fire Truck
GG	GG	Truck Garbage or Refuse
GL	GL	Truck Gliders
GN	GN	Truck Grain
HB	HB	Passenger Vehicle Hatchback Number Doors Unknown
HO	HO	Truck Hopper
HR	HR	Passenger Vehicle Hearse
HT	HT	Passenger Vehicle Hardtop Number Doors Unknown
IC	IC	Truck Incomplete Chassis
IE	IE	Truck Incomplete Ext Van
--	IN	Passenger Vehicle Incomplete Passenger
LB	LB	Passenger Vehicle Liftback
LG	LG	Truck Logger
LL	LL	Truck Suburban & Carry-All
LM	LM	Passenger Vehicle Limousine
--	LM	Truck Limousine
MH	MH	Truck Motorized Home
MK	MK	Motorcycle Mini-Bike
MN	MM	Motorcycle Mini Moto Cross
MM	MP	Motorcycle Moped

V116 VIN Body Type (continued)

Attribute Codes

1982- 2009	2010- Later	
MP	MP	Truck Multipurpose
MR	MR	Motorcycle Mini Road/Trail
MS	MS	Motorcycle Motor Scooter
MV	MV	Truck Maxi-Van
--	MW	Truck Maxi Wagon
MX	MX	Motorcycle Moto Cross
MY	MY	Truck Motorized Cutaway
MY	MY	Motorcycle Mini-Cycle
NB	NB	Passenger Vehicle Notchback
--	P2	Passenger Vehicle 2-Passenger Low Speed
--	P2	Passenger Vehicle 4-Passenger Low Speed
PC	PC	Truck Club Cab Pickup
PD	PD	Truck Parcel Delivery
PK	PK	Truck Pickup
PK	PK	Passenger Vehicle Pickup, Truck Commonly Registered Passengers
PM	PM	Truck Pickup with Camper Mounted on Bed
PN	PN	Truck Panel
PS	PS	Truck Super Cab Pickup
RC	RC	Motorcycle Racer
PN	PN	Passenger Vehicle Panel, Truck Commonly Registered as Passengers
RD	RD	Truck Roadster (<i>Jeep, Jeep Commando</i>)
RD	RD	Passenger Vehicle Roadster
RS	RS	Motorcycle Road/Street
RT	RT	Motorcycle Road/Trail
S1	S1	Truck One-Seat
S2	S2	Truck Two-Seat
SB	SB	Passenger Vehicle Sport Hatchback
SC	SC	Passenger Vehicle Sport Coupe
SD	SD	Passenger Vehicle Sedan, number doors unknown
SN	SN	Truck Step Van
SP	SP	Truck Sport Pickup
ST	ST	Truck Stake or Rack
SV	SV	Truck Sports Van
SV	SV	Passenger Vehicle Sport Van
SW	SW	Passenger Vehicle Station Wagon
SW	SW	Truck Station Wagon (<i>Jeep Wagoneer, etc.</i>)
T	T	Motorcycle Dirt
TB	TB	Truck Tilt Cab
TL	TL	Truck Tilt Tandem
TL	TL	Motorcycle Trail/Dirt
TM	TM	Truck Tandem
TN	TN	Truck Tank

V116 VIN Body Type (continued)

Attribute Codes

1982- 2009	2010- Later	
TR	TR	Motorcycle Trails
TR	TR	Truck Tractor (<i>Gasoline</i>)
UT	UT	Passenger Vehicle Utility, truck commonly registered as passenger
UT	UT	Truck Utility (<i>Blazer, Jimmy, Scout, etc.</i>)
VC	VC	Truck Van Camper
VD	VD	Truck Display Van
VN	VN	Truck Van
VT	VT	Truck Vanette (<i>Includes Metro and Handy Van</i>)
VW	VW	Truck Window Van
WK	WK	Truck Tow Truck Wrecker
WW	WW	Truck Wide Wheel Wagon
WW	WW	Passenger Vehicle Wide-Wheel Wagon
XT	XT	Truck Travel-all
YY	YY	Truck Cutaway
99	99	Unknown

V117 VIN Model Year

Definition: This element represents the 2-digit model year of the vehicle.

Additional Information:

SAS Name: **PVINMDYR**

Attribute Codes

2010-Later

xx 2-Digit Model Year

V118 Curb Weight

Definition: This element provides the base weight for the vehicle model.

Additional Information:

SAS Name: **PVIN_WGT**

Attribute Codes***1975-Later***

0	Not Available
1-9998	Actual weight of Automobile in Pounds
9999	Value Not Coded

V119 Wheelbase Short

Definition: The shortest wheelbase respectively for the manufactured model as determined by the VINA program for automobiles.

Additional Information:

SAS Name: PWHLBS_SH

Attribute Codes**1975-Later**

0000	Value Not Available from the VINA Program
1-9998	Actual Value in Inches
9999	Value Not Coded

V120 Wheelbase Long

Definition: The longest wheelbase respectively for the manufactured model as determined by the VINA program for automobiles.

Additional Information:

SAS Name: PWHLBS_LG

Attribute Codes**1975-Later**

0000	Value Not Available from the VINA Program
1-9998	Actual Value in Inches
9999	Value Not Coded

V121 Fuel Code

Definition: This element identifies the fuel type for a vehicle determined by the manufacturer specification and recommendation.

Additional Information: This is RLPolk VINA decode data. Prior to 2010, this variable was derived for trucks only. Since 2010 this element is coded for all vehicles.

SAS Name: **PFUECODE**

Attribute Codes

1975- 2009	2010- Later	
--	B	Electric and Gasoline Hybrid Engine
C	C	Gasoline Engine That Can Be Easily Converted to Gaseous-Powered Engine (Powered by Natural Gas, Propane, etc.)
D	D	Diesel
E	E	Electric
F	F	Flexible Fuel
G	G	Gas
H	H	Ethanol Fuel Only
M	M	Methanol Gas Only
N	N	Compressed Natural Gas
P	P	Propane
9	9	Unknown

V122 VIN Truck Series

Definition: This element identifies the model (series) of the truck.

Additional Information: This material comes from analysis of the Vehicle Identification Number. This is a CHARACTER variable in UPPER CASE three characters long.

The values for SER_TR are contained in the Appendix of PC VINA User's Manual. They are the first column headed VINA CODE for the series name. When using the variable SER_TR all model names, in the last column are included. If one wishes to select a specific truck model one uses the FARS variable VINA_MOD set to the value in the last column headed VINA CODE.

See Appendix of the PC VINA User's Manual.

SAS Name: **P**SER_TR

Attribute Codes**1975-Later**

xxx 3-Character Model (Series) Abbreviation

V123 Truck Weight Rating

Definition: This element provides weight ranges for trucks based on manufacturer specifications.

Additional Information: For model year 1966 and newer trucks.

Often coded as 9 for buses.

SAS Name: PWGTCD_TR

Attribute Codes***1975-Later***

- | | |
|---|---------------------|
| 1 | 6,000 lbs or Less |
| 2 | 6,001 - 10,000 lbs |
| 3 | 10,001 - 14,000 lbs |
| 4 | 14,001 - 16,000 lbs |
| 5 | 16,001 - 19,500 lbs |
| 6 | 19,501 - 26,000 lbs |
| 7 | 26,001 - 33,000 lbs |
| 8 | 33,001 and Up |
| 9 | Unknown |

V124 Motorcycle Engine Displacement (CC)

Definition: This is the piston bore measured in cubic centimeters. This is a numeric value (example, Honda 160 cc engine). This field is 4 positions long.

Additional Information: This variable also appears in the Person data set and in the Parkwork data set as PMCYCL_DS.

SAS Name: **PMCYCL_DS**

Attribute Codes**1975-Later**

xxxx Actual Displacement (cc)

V125 VIN Length

Definition: This is the actual length of the vehicle identification number

Additional Information:

SAS Name: `PVIN_LNGT`

Attribute Codes***1981-Later***

1-17	Actual Value
99	Unknown VIN Length

V150 Fatalities in Vehicle (Number)

Definition: The number of fatalities that occurred in the vehicle.

Additional Information: The variable FATALS in the Accident file, under the heading Fatalities, provides the number of deaths for the entire crash.

This is a derived variable and is not coded on the form directly. In 1976, this value is always set to 0.

SAS Name: PDEATHS

Attribute Codes**1975-Later**

00-99 Number of Fatalities that Occurred in the Vehicle.

The PBTYP E Data Set

The Pbt ype data set contains the variables ST_CASE, STATE, VEH_NO and PER_NO. ST_CASE, VEH_NO and PER_NO are the case identifiers. The data set also contains:

P5/NM5Age

Definition: This element identifies the person's age, in years, with respect to the person's last birthday.

Additional Information:

SAS Name: PBAGE

Attribute Codes**1975-2008**

00	Up to One Year
01-96	Age of the Individual in Years
97	97 Years Old or Older
99	Unknown

2010-**2009****Later**

000	000	Less than One Year
001-120	001-120	Age of the Individual in Years
--	998	Not Reported
999	999	Unknown

P6/NM6Sex

Definition: This element identifies the sex of the person involved in the crash

Additional Information: From 1975 to 1981, if no information was known about the hit-and-run vehicle and/or driver, then neither the vehicle form nor the driver form were filled out and were not counted in the FARS census. Starting in 1982 both a vehicle and a driver form were filled out and the data were identified as unknown. This is why there were approximately only 20 to 40 drivers with unknown sex listed in the FARS data set from 1975 to 1981 and 700 to 1000 drivers with unknown sex from 1982 on.

On March 22, 1995, a quick review of the 1994 Annual Report File revealed that of the 768 persons in the 1994 file with unknown sex; over 90 percent were involved in hit-and-run crashes.

SAS Name: **PBSEX**

Attribute Codes

1975- 2009	2010- Later	
1	1	Male
2	2	Female
--	8	Not Reported
9	9	Unknown

P7/NM7 Person Type

Definition: This element describes the role of this person involved in the crash.

Additional Information:

SAS Name: **PBPTYPE**

Attribute Codes**1975-1981**

- 1 Driver
- 2 Passenger
- 3 Non-Motorist: Pedestrian
- 4 Non-Motorist: Pedalcyclist
- 5 Non-Motorist: Occupant of Non-Traffic-Unit Vehicle
- 8 Non-Motorist: Other or Unknown
- 9 Occupant: Unknown Type

1982-1993

- 1 Driver of a Motor Vehicle in Transport
- 2 Passenger of a Motor Vehicle in Transport
- 3 Occupant of a Motor Vehicle Not in Transport
- 4 Occupant of a Non-Motor Vehicle Transport Device (*e.g., Horse and Buggy*)
- 5 Non-Occupant Pedestrian
- 6 Non-Occupant Bicyclist
- 7 Non-Occupant Other Cyclist
- 8 Non-Occupant Other or Unknown
- 9 Unknown Occupant Type in a Motor Vehicle in Transport

1994-2009

- 01 Driver
- 02 Passenger of a Motor Vehicle in Transport
- 03 Occupant of a Motor Vehicle Not in Transport
- 04 Occupant of a Non-Motor Vehicle Transport Device
- 05 Pedestrian
- 06 Bicyclist
- 07 Other Cyclist
- 08 Persons on Personal Conveyances (*Since 2007*)
- 08 Other Pedestrian (*Includes Persons on Personal Conveyances, 1994-2006*)
- 09 Unknown Occupant Type in a Motor Vehicle in Transport
- 10 Persons In/On Buildings (*Since 2007*)
- 19 Unknown Type of Non-Motorist
- 99 Unknown

NM9 Marked Crosswalk Present – Pedestrian/Bicyclist

Definition: This element indicates if a marked crosswalk was present at the crash site.

Additional Information:

SAS Name: PBCWALK

Attribute Codes

2010-Later

- 0 No
- 1 Yes
- 9 Unknown

NM9 Side Walk Present – Pedestrian/Bicyclist

Definition: This element indicates if a sidewalk was present at the crash site.

Additional Information:

SAS Name: PBSWALK

Attribute Codes

2010-Later

- 0 No
- 1 Yes
- 9 Unknown

NM9 School Zone – Pedestrian/Bicyclist

Definition: This element indicates if the crash occurred in a school zone.

Additional Information:

SAS Name: **PBSZONE**

Attribute Codes

2010-Later

- 0 No
- 1 Yes
- 9 Unknown

NM9 Crash Type – Pedestrian

Definition: This element describes the crash situation involving the pedestrian.

Additional Information:

SAS Name: **PEDCTYPE**

Attribute Codes

2010-Later

000	Not a Pedestrian
110	Assault with Vehicle
120	Dispute-Related
130	Pedestrian on Vehicle
140	Vehicle-Vehicle/Object
150	Motor Vehicle Loss of Control
160	Pedestrian Loss of Control
190	Other Unusual Circumstances
211	Backing Vehicle - Driveway
212	Backing Vehicle - Driveway/Sidewalk Intersection
213	Backing Vehicle - Roadway
214	Backing Vehicle - Parking Lot
219	Backing Vehicle - Other/Unknown
220	Driverless Vehicle
230	Disabled Vehicle-Related
240	Emergency Vehicle-Related
250	Play Vehicle-Related
311	Working in Roadway
312	Playing in Roadway
313	Lying in Roadway
320	Entering/Exiting Parked Vehicle
330	Mailbox-Related
341	Commercial Bus-Related
342	School Bus-Related
360	Ice Cream/Vendor Truck-Related
410	Walking Along Roadway With Traffic - From Behind
420	Walking Along Roadway With Traffic - From Front
430	Walking Along Roadway Against Traffic - From Behind
440	Walking Along Roadway Against Traffic - From Front
459	Walking Along Roadway - Direction/Position Unknown
460	Motorist Entering Driveway or Alley
465	Motorist Exiting Driveway or Alley
469	Driveway Crossing - Other/Unknown
510	Waiting to Cross - Vehicle Turning
520	Waiting to Cross - Vehicle Not Turning
590	Waiting to Cross - Vehicle Action Unknown

NM9 Crash Type – Pedestrian (continued)

Attribute Codes**2010-Later**

610	Standing in Roadway
620	Walking in Roadway
680	Non-Intersection - Other/Unknown
690	Intersection - Other/Unknown
710	Multiple Threat
730	Trapped
741	Dash
742	Dart-Out
760	Pedestrian Failed to Yield
770	Motorist Failed to Yield
781	Motorist Left Turn - Parallel Paths
782	Motorist Left Turn - Perpendicular Paths
791	Motorist Right Turn - Parallel Paths
792	Motorist Right Turn on Red - Parallel Paths
794	Motorist Right Turn on Red - Perpendicular Paths
795	Motorist Right Turn - Perpendicular Paths
799	Motorist Turn/Merge - Other/Unknown
830	Off Roadway - Parking Lot
890	Off Roadway - Other/Unknown
900	Other - Unknown Location
910	Crossing an Expressway

NM9 Crash Type – Bicyclist

Definition: This element describes the crash situation involving the bicyclist.

Additional Information:

SAS Name: BIKECTYPE

Attribute Codes**2010-Later**

000	Not a Cyclist
111	Motorist Turning Error - Left Turn
112	Motorist Turning Error - Right Turn
113	Motorist Turning Error - Other
114	Bicyclist Turning Error - Left Turn
115	Bicyclist Turning Error - Right Turn
116	Bicyclist Turning Error - Other
121	Bicyclist Lost Control - Mechanical Problems
122	Bicyclist Lost Control - Oversteering, Improper Braking, Speed
123	Bicyclist Lost Control - Alcohol/Drug Impairment
124	Bicyclist Lost Control - Surface Conditions
129	Bicyclist Lost Control - Other/Unknown
131	Motorist Lost Control - Mechanical Problems
132	Motorist Lost Control - Oversteering, Improper Braking, Speed
133	Motorist Lost Control - Alcohol/Drug Impairment
134	Motorist Lost Control - Surface Conditions
139	Motorist Lost Control - Other/Unknown
141	Motorist Drive-out Sign-Controlled Intersection
142	Bicyclist Ride-out Sign-Controlled Intersection
143	Motorist Drive-Through-Sign-Controlled Intersection
144	Bicyclist Ride-Through-Sign-Controlled Intersection
147	Multiple Threat - Sign-Controlled Intersection
148	Sign-Controlled Intersection - Other/Unknown
151	Motorist Drive-out - Right Turn on Red
152	Motorist Drive-out - Signalized Intersection
153	Bicyclist - Ride-out - Signalized Intersection
154	Motorist Drive-Through - Signalized Intersection
155	Bicyclist Ride-Through - Signalized Intersection
156	Bicyclist Failed to Clear - Trapped
157	Bicyclist Failed to Clear - Multiple Threat
158	Signalized Intersection - Other/Unknown
159	Bicyclist Failed to Clear - Unknown
160	Crossing Paths - Uncontrolled Intersection
180	Crossing Paths - Intersection - Other/Unknown
211	Motorist Left Turn - Same Direction
212	Motorist Left Turn - Opposite Direction
213	Motorist Right Turn - Same Direction
214	Motorist Right Turn - Opposite Direction

NM9 Crash Type – Bicyclist (continued)

Attribute Codes**2010-Later**

215	Motorist Drive-in/out - Parking
216	Bus/Delivery Vehicle Pullover
217	Motorist Right Turn on Red - Same Direction
218	Motorist Right Turn on Red - Opposite Direction
219	Motorist Right Turn on Red - Other/Unknown
221	Bicyclist Left Turn - Same Direction
222	Bicyclist Left Turn - Opposite Direction
223	Bicyclist Right Turn - Same Direction
224	Bicyclist Right Turn - Opposite Direction
225	Bicyclist Ride-out - Parallel Path
231	Motorist Overtaking - Undetected Bicyclist
232	Motorist Overtaking - Misjudged Space
235	Motorist Overtaking - Bicyclist Swerved
239	Motorist Overtaking - Other/Unknown
241	Bicyclist Overtaking - Passing on Right
242	Bicyclist Overtaking - Passing on Left
243	Bicyclist Overtaking - Parked Vehicle
244	Bicyclist Overtaking - Extended Door
249	Bicyclist Overtaking - Other/Unknown
250	Head-on - Bicyclist
255	Head-on - Motorist
259	Head-on - Unknown
280	Parallel Paths - Other/Unknown
311	Bicyclist Ride-out - Residential Driveway
312	Bicyclist Ride-out - Commercial Driveway/Alley
318	Bicyclist Ride-out - Other Midblock
319	Bicyclist Ride-out - Unknown
321	Motorist Drive-out - Residential Driveway
322	Motorist Drive-out - Commercial Driveway/Alley
328	Motorist Drive-out - Other Midblock
329	Motorist Drive-out - Midblock - Unknown
357	Multiple Threat - Midblock
380	Crossing Paths - Midblock - Other/Unknown
400	Bicycle Only
510	Motorist Intentionally Caused
520	Bicyclist Intentionally Caused
600	Backing Vehicle
700	Play Vehicle-Related
800	Unusual Circumstances
910	Non-Roadway
970	Unknown Approach Paths
980	Unknown Location

NM9 Crash Location – Pedestrian

Definition: This element identifies the location of the pedestrian at the time of the crash.

Additional Information:

SAS Name: PEDLOC

Attribute Codes*2010-Later*

- 1 Intersection
- 2 Intersection-Related
- 3 Non-Intersection
- 4 Non-Roadway
- 7 Not a Pedestrian
- 9 Unknown/Insufficient Information

NM9 Crash Location – Bicyclist

Definition: This element identifies the location of the bicyclist at the time of the crash.

Additional Information:

SAS Name: BIKELOC

Attribute Codes***2010-Later***

- 1 Intersection
- 2 Intersection-Related
- 3 Non-Intersection
- 4 Non-Roadway
- 7 Not a Cyclist
- 9 Unknown/Insufficient Information

NM9 Pedestrian Position

Definition: This element identifies the position of the pedestrian when struck.

Additional Information:

SAS Name: PEDPOS

Attribute Codes

2010-Later

INTERSECTION OR INTERSECTION RELATED

- 01 Intersection Proper
- 02 Crosswalk Area
- 03 Travel Lane
- 04 Paved Shoulder/Bike Lane/Parking Lane
- 05 Sidewalk/Shared Use Path/Driveway Crossing
- 06 Unpaved Right-of-Way
- 07 Driveway/Alley
- 08 Non-Roadway-Parking Lot/Other
- 09 Other/Unknown
- 77 Not a Pedestrian

NM9 **Bicyclist Position**

Definition: This element identifies the position of the bicyclist when struck.

Additional Information:

SAS Name: BIKEPOS

Attribute Codes***2010-Later***

- 1 Travel Lane
- 2 Bike Lane/Paved Shoulder
- 3 Sidewalk/Crosswalk/Driveway Crossing
- 4 Multi-Use Path
- 5 Driveway/Alley
- 6 Non-Roadway
- 7 Not a Cyclist
- 8 Other
- 9 Unknown

NM9 Pedestrian Direction

Definition: This element identifies the pedestrian's initial direction of travel.

Additional Information:

SAS Name: PEDDIR

Attribute Codes***2010-Later***

- 1 North
- 2 East
- 3 South
- 4 West
- 7 Not a Pedestrian
- 8 Not Applicable
- 9 Unknown

NM9 **Bicyclist Direction**

Definition: This element identifies the bicyclist's initial direction of travel.

Additional Information:

SAS Name: **BIKEDIR**

Attribute Codes

2010-Later

- 1 With Traffic
- 2 Facing Traffic
- 3 Not Applicable
- 7 Not a Cyclist
- 9 Unknown

NM9 Motorist Direction

Definition: This element identifies the motorist's initial direction of travel.

Additional Information:

SAS Name: MOTDIR

Attribute Codes***2010-Later***

- 1 North
- 2 East
- 3 South
- 4 West
- 7 Not a Pedestrian
- 8 Not Applicable
- 9 Unknown

NM9 Motorist Maneuver

Definition: This element identifies the motorist's maneuver at the time of the collision.

Additional Information:

SAS Name: MOTMAN

Attribute Codes***2010-Later***

- 1 Left Turn
- 2 Right Turn
- 3 Straight Through
- 7 Not a Pedestrian
- 9 Unknown

NM9 Intersection Leg

Definition: This element identifies the leg of the intersection where the crash occurred.

Additional Information:

SAS Name: PEDLEG

Attribute Codes***2010-Later***

- 1 Near
- 2 Far
- 7 Not a Pedestrian
- 8 Not Applicable
- 9 Unknown

NM9 Pedestrian Scenario

Definition: This element describes the crash scenario involving the pedestrian.

Additional Information:

SAS Name: PEDSNR

Attribute Codes

2010-Later

MOTORIST TRAVELING STRAIGHT THROUGH – CRASH OCCURRED ON NEAR (APPROACH) SIDE OF INTERSECTION

- 1a Pedestrian Within Crosswalk Area, Traveled From Motorist's Left.
- 1b Pedestrian Within Crosswalk Area, Traveled From Motorist's Right.
- 1c Pedestrian Within Crosswalk Area, Approach Direction Unknown.
- 2a Pedestrian Outside Crosswalk Area, Traveled From Motorist's Left.
- 2b Pedestrian Outside Crosswalk Area, Traveled From Motorist's Right.
- 2c Pedestrian Outside Crosswalk Area, Approach Direction Unknown.

MOTORIST TRAVELING STRAIGHT THROUGH – CRASH OCCURRED ON FAR SIDE OF INTERSECTION

- 3a Pedestrian Within Crosswalk Area, Traveled From Motorist's Left.
- 3b Pedestrian Within Crosswalk Area, Traveled From Motorist's Right.
- 3c Pedestrian Within Crosswalk Area, Approach Direction Unknown.
- 4a Pedestrian Outside Crosswalk Area, Traveled From Motorist's Left.
- 4b Pedestrian Outside Crosswalk Area, Traveled From Motorist's Right.
- 4c Pedestrian Outside Crosswalk Area, Approach Direction Unknown.

MOTORIST TURNING RIGHT - CRASH OCCURRED ON NEAR (APPROACH) SIDE OF INTERSECTION

- 5a Pedestrian Within Crosswalk Area, Traveled From Motorist's Left.
- 5b Pedestrian Within Crosswalk Area, Traveled From Motorist's Right.
- 5c Pedestrian Within Crosswalk Area, Approach Direction Unknown.
- 6a Pedestrian Outside Crosswalk Area, Traveled From Motorist's Left.
- 6b Pedestrian Outside Crosswalk Area, Traveled From Motorist's Right.
- 6c Pedestrian Outside Crosswalk Area, Approach Direction Unknown.

MOTORIST TURNING RIGHT - CRASH OCCURRED ON FAR SIDE OF INTERSECTION

- 7a Pedestrian Within Crosswalk Area, Approach Direction Same as Motorist's.
- 7b Pedestrian Within Crosswalk Area, Approach Direction Opposite Motorist's.
- 7c Pedestrian Within Crosswalk Area, Approach Direction Unknown.
- 8a Pedestrian Outside Crosswalk Area, Approach Direction Same as Motorist's.
- 8b Pedestrian Outside Crosswalk Area, Approach Direction Opposite Motorist's.
- 8c Pedestrian Outside Crosswalk Area, Approach Direction Unknown.

NM9 Pedestrian Scenario (continued)

Attribute Codes*2010-Later***MOTORIST TURNING LEFT - CRASH OCCURRED ON NEAR (APPROACH) SIDE OF INTERSECTION**

- 9a Pedestrian Within Crosswalk Area, Traveled From Motorist's Left.
- 9b Pedestrian Within Crosswalk Area, Traveled From Motorist's Right.
- 9c Pedestrian Within Crosswalk Area, Approach Direction Unknown.
- 10a Pedestrian Outside Crosswalk Area, Traveled From Motorist's Left.
- 10b Pedestrian Outside Crosswalk Area, Traveled From Motorist's Right.
- 10c Pedestrian Outside Crosswalk Area, Approach Direction Unknown.

MOTORIST TURNING LEFT - CRASH OCCURRED ON FAR SIDE OF INTERSECTION

- 11a Pedestrian Within Crosswalk Area, Approach Direction Same as Motorist's.
- 11b Pedestrian Within Crosswalk Area, Approach Direction Opposite Motorist's.
- 11c Pedestrian Within Crosswalk Area, Approach Direction Unknown.
- 12a Pedestrian Outside Crosswalk Area, Approach Direction Same as Motorist's.
- 12b Pedestrian Outside Crosswalk Area, Approach Direction Opposite Motorist's.
- 12c Pedestrian Outside Crosswalk Area, Approach Direction Unknown.
- 7 Not a Pedestrian
- 8 Not Applicable

NM9 Pedestrian Crash Group

Definition: This element categorizes the pedestrian crash types described by the element Crash Type - Pedestrian.

Additional Information:

SAS Name: PEDCGP

Attribute Codes***2010-Later***

000	Not a Pedestrian
100	Unusual Circumstances
200	Backing Vehicle
310	Working or Playing in Roadway
340	Bus-Related
350	Unique Midblock
400	Walking Along Roadway
460	Crossing Driveway or Alley
500	Waiting to Cross
600	Pedestrian in Roadway - Circumstances Unknown
720	Multiple Threat/Trapped
740	Dash/Dart-Out
750	Crossing Roadway - Vehicle Not Turning
790	Crossing Roadway - Vehicle Turning
800	Off Roadway
910	Crossing Expressway
990	Other/Unknown - Insufficient Details

NM9 Bicycle Crash Group

Definition: This element categorizes the bicyclist crash types described by the element Crash Type - Bicyclist.

Additional Information:

SAS Name: BIKECGP

Attribute Codes

2010-Later

000	Not a Cyclist
110	Loss of Control/Turning Error
140	Motorist Failed to Yield - Sign-Controlled Intersection
145	Bicyclist Failed to Yield - Sign-Controlled Intersection
150	Motorist Failed to Yield - Signalized Intersection
158	Bicyclist Failed to Yield - Signalized Intersection
190	Crossing Paths - Other Circumstances
210	Motorist Left Turn/Merge
215	Motorist Right Turn/Merge
219	Parking/Bus-Related
220	Bicyclist Left Turn/Merge
225	Bicyclist Right Turn/Merge
230	Motorist Overtaking Bicyclist
240	Bicyclist Overtaking Motorist
258	Head-On
290	Parallel Paths - Other Circumstances
310	Bicyclist Failed to Yield - Midblock
320	Motorist Failed to Yield - Midblock
600	Backing Vehicle
850	Other/Unusual Circumstances
910	Non-Roadway
990	Other/Unknown - Insufficient Details

Appendices

Appendix A: Vehicle Make/Model Designation

Appendix B: V23 Accident Type Diagram

Appendix C: Additional Variable Information

Appendix D: FARS Variables by SAS Table and Year

Appendix A: Vehicle Make/Model Designation

The Make data is concatenated with the Model data to form the make-model variable. The first two digits identify the make, the next two digits identify the model. If one needs to select cars based on make and model the variable of choice is VINA_MOD rather than MAK_MOD.

01 AMERICAN MOTORS

CODE	MODEL	INCLUDES	YEAR
001	Rambler/American	Rogue, Scrambler, 220, 440,	all
002	Rebel/Matador	Barcelona Classic Brougham, 550, 660, 770, Matador (-78), Marlin	all
003	Ambassador	Brougham, DPL, SST, DL, Limited, 880, 990	all
004	Pacer	Limited, DL	75-80
005	AMX	(2 seater only)	68-70
006	Javelin	SST, AMX (71-74)	all
007	Hornet/Concord	Sportabout, Limited, DL, SC-360, SST, AMX (75-78)	all
008	Spirit/Gremlin	Limited, DL, Custom, X, GT (83-on), AMX (79-on)	all
009	Eagle	Concord based	80-87
010	Eagle SX-4	Spirit Gremlin based	81-84
398	Other automobile		-
399	Unknown automobile		-
998	Other vehicle		-
999	Unknown vehicle		-

Note: Alliance, Encore, Premier- See Renault - Code "46"

02 JEEP (Includes KAISER-JEEP)

CODE	MODEL	INCLUDES	YEAR
001	Compass		-
399	Unknown automobile		-
401	CJ-2/CJ-3/CJ-4	Military	-66
402	CJ-5/CJ-6/CJ-7/ CJ-8	Scrambler, Golden Eagle, Renegade, Laredo, Wrangler	67-on
403	YJ-series	Wrangler	86-on
404	Cherokee (84-on)	Limited, Laredo, Pioneer, Briarwood, Grand	84-on
405	Liberty		2002
406	Commander		-
407	Patriot		-
421	Cherokee (-83)	Wide Track, Chief, Commando, Jeepster	all
431	Grand Wagoneer	Custom, Brougham Limited, Wagoneer	71-91
481	Pickup	J-10, J-20, Honcho	all
482	Comanche	Chief	86-92
498	Other light truck		-
499	Unknown light truck		-
998	Other vehicle		-
999	Unknown vehicle		-

03 AM GENERAL

CODE	MODEL	INCLUDES	YEAR
401	Dispatcher	Post Office (Jeep)	all
402	Hummer H3		-
421	Hummer		93-on
466	Dispatcher	DJ-series-Post Office Van	all
498	Other light truck		-
499	Unknown light truck		-
884	Medium/Heavy truck	Military off-road	-
898	Other medium-heavy truck		-
899	Unknown medium/heavy truck		-
950	Bus based Motorhome		-
983	Bus flat front (rear engine) Transit		-
988	Other bus		-
989	Unknown bus		-
998	Other vehicle		-
999	Unknown vehicle		-

06 CHRYSLER

CODE	MODEL	INCLUDES	YEAR
009	Cordoba	Crown, 300, LS	75-83
010	New Yorker/Newport/ Fifth Avenue/Imperial	Custom, Royal, Brougham, Town and Country, 300 (-71) (excludes all FWD)	all
014	New Yorker/E Class/ Imperial (90-93)/Fifth Avenue	FWD vehicles, Turbo	83-on
015	Laser	Turbo, XE, XT	84-86
016	LeBaron	Medallion, Salon(RWD), Landau, LX, FWD except GTS or GTC Sport Coupe	77-on
017	LeBaron GTS/GTC	GTS-Turbo GTC-Sport Coupe	85-on 87-on
018	Intrepid (Canadian made)		-
019	Neon (export)		-
031	TC (Maserati Sport)	Turbo Convertible	88-91
035	Conquest	TSi, Turbo	87-89
041	Concorde		93-on
042	LHS	New Yorker (94-on)	94-on
043	Sebring		95-on
044	Cirrus		95-on
051	300M		-
052	PT Cruiser		2001-on
053	Prowler		-
054	Pacifica		-
055	Crossfire		-
398	Other automobile		-
399	Unknown automobile		-
421	Aspen		-
441	Town and Country	Minivan	90-on
442	Voyager		2002
498	Other light truck		-
499	Unknown light truck		-
998	Other vehicle		-
999	Unknown vehicle		-

07 DODGE

CODE	MODEL	INCLUDES	YEAR
001	Dart	Custom, Swinger, Sport, GT, Demon, Special, Special Edition, 170,270,340,360	62-76
002	Coronet/Charger(-78)/ Magnum	Brougham, Custom, Superbee, Crestwood, Deluxe, XE, R/T, SE, 440, 500, Police	-79
003	Polara/Monaco Royal Monaco	Custom, Special, Crestwood, Brougham, Police, Taxi	-78
004	Viper	RT/10	92-on
005	Challenger	R/T, T/A, Rallye	70-74
006	Aspen	Custom, Special Edition, Police, R/T, Sport	76-80
007	Diplomat	Medallion, Salon, S	77-89
008	Omni/Charger (83 on)	024, DeTomaso Miser, GLH, GLHS, Shelby, Charger 2.2, America, Expo	78-90
009	Mirada		80-83
010	St. Regis	Police, Taxi	79-81
011	Aries (K)	Custom, SE, LE	81-89
012	400	LS	82-83
013	Rampage (car based pickup)	2.2, GT, Sport	82-84
014	600	ES, Turbo	83-88
015	Daytona	Turbo Z, Shelby Z Pacifica, C/S Competition, IROC R/T	84-94
016	Lancer	Pacifica, Turbo, ES, Shelby	85-89
017	Shadow	ES, Turbo	87-on
018	Dynasty		88-on
019	Spirit	ES, Shelby, RT	89-94
020	Neon	Expresso	94-on
021	Magnum		-
024	Charger (2006+)		-
025	Caliber		-
026	Avenger		-
027	Journey	SE, SXT, R/T	2009-on
028	Challenger (2008+)		2008-on
033	Challenger	all imported	78-83
034	Colt (excludes Vista)	RS, Turbo, Custom, GTS, DL, E, Premier, Deluxe, Carousel, GT	74-94
035	Conquest	Turbo	84-86

07 DODGE (continued)

039	Stealth		91-on
040	Monaco		90-92
041	Intrepid		93-on
042	Avenger		95-on
043	Stratus		95-on
398	Other automobile		-
399	Unknown automobile		-
401	Raider	Sport	86-on
403	Nitro		-
421	Ramcharger		all
422	Durango		98-00
441	Vista	4x4	84-91
442	Caravan	Mini-Ram, SE	84-on
461	B-series vans	Sportsman, Royal, Maxiwagon, Ram B150-B350, Tradesman	all
462	Sprinter		-
470	Van derivative	Kary Van	all
471	D50, Colt P/U, RAM50/RAM 100		all
472	Dakota		87-on
481	D, W-series pickup	Ram, Custom, Royal, Miser, D100-D350, W100-W350	all -
482	Ram	1500/2500/3500 P/U	94-on
498	Other light truck		-
499	Unknown light truck		-
850	Truck based motorhome		-
881	Medium/Heavy	CBE	all
882	Medium/Heavy	COE	low entry
883	Medium/Heavy	COE	high entry
884	Medium/Heavy		unknown engine location
890	Medium/Heavy	COE	entry position unknown
898	Other medium/heavy truck		-
899	Unknown Medium/heavy truck		-
950	Bus based motorhome		-
981	Medium bus	(not van based)	-
988	Other bus		-
989	Unknown bus		-
998	Other vehicle		-
999	Unknown vehicle		-

08 IMPERIAL

CODE	MODEL	INCLUDES	YEAR
010	Imperial	Lebaron Mark Cross, Frank Sinatra editions	-76 81-83
398	Other automobile		-
399	Unknown automobile		-
998	Other vehicle		-
999	Unknown vehicle		-

09 PLYMOUTH

CODE	MODEL	INCLUDES	YEAR
001	Valiant/Duster (-76)/ Scamp	100, 200, Brougham, Signet, Custom, Special 340/360, 340, 360, Twister	-76
002	Satellite/Belvedere	Belvedere I/II, GTX, Roadrunner (-74), Sebring, Sebring Plus, Superbird, Brougham	-74
003	Fury	I, II, III, Roadrunner (75), Salon, VIP, Sport, Suburban	-74 75-78
004	Gran Fury	Sedan, Brougham, Custom Sport, Suburban	75-89
005	Barracuda	Formula, S, 340, AAR, Cuda, Gran Coupe	65-74
006	Volaré	Custom, Premier, Roadrunner (76-on), Police	76-80
007	Caravelle	Turbo, SE	85-89
008	Horizon	TC-3, Miser, Turismo 2.2, Custom, SE, Duster (85-on), America, Expo	78-90
011	Reliant (K)	SE, LE	81-89
013	Scamp (car based pickup)	GT, 2.2	82-84
017	Sundance	Turbo	87-on
019	Acclaim	LX, LE	89-on
020	Neon	Expresso	94-on
031	Cricket		71-72
032	Arrow	Fire Arrow, GS, GT	76-80
033	Sapporo	all imported	78-83
034	Champ/Colt (excludes Vista)	Turbo, Custom-Station Wagon (84-on)	79-94
035	Conquest	TSi	84-89
038	Breeze		96-on
039	Prowler		96-on
037	Laser	RS, Turbo	89-on
398	Other automobile		-
399	Unknown automobile		-
421	Trailduster		all
441	Vista	4x4	87-on
442	Voyager (minivan)	SE, LX	84-on
461	Van-fullsize (B-series)	Voyager, Sport, Premier	all
471	Arrow pickup (foreign)		all

09 PLYMOUTH (continued)

498	Other light truck	-
499	Unknown light truck	-
998	Other vehicle	-
999	Unknown vehicle	-

10 EAGLE

CODE	MODEL	INCLUDES	YEAR
034	Summit	DL, LX, ES	89-on
037	Talon	TSI	90-on
040	Premier	LX, ES	88-92
041	Vision		93-on
044	Medallion	DL, LX	88-90
398	Other automobile		-
399	Unknown automobile		-
441	Summit Wagon		92-on
498	Other light truck		-
499	Unknown light truck		-
998	Other vehicle		-
999	Unknown vehicle		-

12 FORD

CODE	MODEL	INCLUDES	YEAR
001	Falcon	Sprint, GT, Futura	-70
002	Fairlane	Torino thru 1970	-70
003	Mustang/Mustang II	Mach, Boss, Grande, Cobra, Ghia, SVO, GT, LX, Shelby	65-on
004	Thunderbird (all sizes)	Landau, Heritage, Turbo coupe, Elan, Fila, Sport, LX, SC	55-on
005	LTD II	S, Squire, Brougham	77-79
006	LTD/Custom/Galaxie (all sizes)	XL, Landau, Ranch Wagon, Country Squire, S, 500, Brougham, XL GT	65-on
007	Ranchero	Falcon/Fairlane based Torino/LTD II based	-71 72-79
008	Maverick	Grabber	70-78
009	Pinto	Pony, MPG, ESS	71-80
010	Torino/Gran Torino/Elite	GT, Cobra, Sport, Squire, Brougham	71-76
011	Granada	ESS, Ghia	75-82
012	Fairmont	Futura, Sport Coupe	78-83
013	Escort/EXP	L, GL, GLX, SS, GT, LX	81-on
015	Tempo	L, GL, GLX, Sport, 4x4	84-94
016	Crown Victoria		81-on
017	Taurus	MT-5, L, GL, LX, SHO	86-on
018	Probe	GL, LX, GT	88-on
021	Five Hundred		-
022	Freestyle		-
023	Fusion		-
024	Edge		-
025	Flex	Includes SE, SEL, Limited	2009-on
031	English Ford	Cortina	60-on
032	Fiesta	Sport, Ghia	78-80
033	Festiva		88-93
034	Laser		93-on
035	Contour		94-on
036	Aspire		94-on
037	Focus		-
038	GT		-
398	Other automobile		all
399	Unknown automobile		-

12 FORD (continued)

401	Bronco II/Bronco (-77) Explorer	Eddie Bauer, XL, XLT Explorer (90-on)	83-on
402	Escape		2001
421	Bronco-fullsize	Eddie Bauer, Custom, XL, XLT	78-on
422	Expedition		97-on
431	Excursion		2000
441	Aerostar	XLT, Cargo Van	86-on
442	Windstar		94-on
443	Freestar		-
444	Transit Connect		2010-on
461	E-series vans	Econoline, Clubwagon, Chateau, E150-E350	all
470	Van derivative	i.e: parcel van	all
471	Ranger	Supercab, 4x4, STX, Splash	82-on
472	Courier	Imported pickup	all
473	Sport Trac		2001
481	F-series pickup	F-100 - F-350	all
498	Other light truck		-
499	Unknown light truck		-
850	Truck based motorhome		-
880	F450/550 Pickup > 4,536 GVW		-
881	Medium/Heavy CBE	F-5 thru F-8 L-series, FT-series	all
882	Medium/Heavy COE	C/CT series, low entry	all
883	Medium/Heavy COE	C/CLT series, high entry	all
884	Medium/Heavy	unknown engine location	-
890	Medium/Heavy COE	entry position unknown	-
898	Other medium/heavy	truck	-
899	Unknown medium/heavy	truck	-
950	Bus based motorhome		-
981	Medium bus	B-series (not van based)	all
988	Other bus		all
989	Unknown bus		-
998	Other vehicle		-
999	Unknown vehicle		-

13 LINCOLN

CODE	MODEL	INCLUDES	YEAR
001	Continental/Town Car	Continental (-81), Town Car (82 on)	all 82-on
002	Mark	I, II, III, IV, V, VI, VII, LSC, VIII All Signature/ Designer Series	all
005	Continental (82-on)	All Signature/Designer Series	-
011	Versailles		77-80
012	LS		2000
013	Zephyr		-
014	MKX		-
015	MDS		-
016	MKT		2009-on
398	Other automobile		-
399	Unknown automobile		-
401	Aviator		-
421	Navigator		97-on
481	Blackwood		2002
482	Mark LT		-
498	Other Light Truck		97-on
499	Unknown Light Truck		97-on
998	Other vehicle		-
999	Unknown vehicle		-

14 MERCURY (MERKUR: See 56)

CODE	MODEL	INCLUDES	YEAR
002	Cyclone	GT, CJ, Spoiler	-71
003	Capri-domestic	RS, Turbo, GS, Black Magic	79-86
004	Cougar/XR7	XR-7, RS, LS, GS, Eliminator, Brougham, Villager, (includes all body styles)	67-on
006	Marquis/Monterey	Marauder, X-100, Parklane, S-55, Custom, Brougham, Montclair, Grand Marquis	55-on
008	Comet	Caliente, GT, Voyager, 202, Capri (66-67)	62-77
009	Bobcat	Runabout, Villager	75-80
010	Montego	Comet (68-70), GT, MX, Villager, Brougham	67-76
011	Monarch	Ghia	75-80
012	Zephyr	GS, Z-7	78-83
013	Lynx/LN-7 (82-83)	L, LS, GS, RS, XR-3	81-87
015	Topaz	L, LS, GS, 4x4	84-on
017	Sable	LS, GS	86-on
020	Montego (2005+)		-
021	Milan		-
031	Capri-foreign	Capri II	70-77
033	Pantera	de Tamaso	72-74
036	Tracer	L, GL	88-on
037	Mystique		94-on
038	Cougar		-
039	Marauder		-
398	Other automobile		-
399	Unknown automobile		-
401	Mountaineer		96-on
402	Mariner		-
443	Villager	LS, GS	93-on
444	Monterey		2004-on
498	Other light truck		-
499	Unknown light truck		-
998	Other vehicle		-
999	Unknown vehicle		-

18 BUICK

CODE	MODEL	INCLUDES	YEAR
001	Special/Skylark	GS, GS-350, GS-400, GS-455, GS, California, Sport wagon, Custom	-72
002	LeSabre/Centurion/Wildcat	Estate Wagon, Luxus, Invicta, Custom, Limited T-Type	55-on
003	Electra, Electra 225, Park Avenue (91-on)	Limited, Park Avenue, Ultra	60-on
004	Roadmaster	Estate Wagon, Limited	91-on
005	Riviera	S-Type, T-Type	63-on
007	Century	Luxus, T-Type Luxus, T-Type, FWD (82-on), Custom, Regal (72-77)	72-on
008	Apollo/Skylark	Skylark (75), S/R	73-76
010	Regal	Turbo, Luxus, Grand National, GNX, T-Type	78-88
012	Skyhawk	S-Type, Roadhawk, T-Type, GT	75-89
015	Skylark (76-85)	(except 75), S/R, S, Limited, Sport, T-Type	-85
018	Somerset/Skylark	Skylark (86-on), Somerset GS, Regal, Custom, Limited, T-Type	85-on
020	Regal (FWD)	Limited	88-on
021	Reatta		88-91
022	Lacrosse		-
023	Lucerne		-
024	Enclave		-
031	Opel Kadett		-75
032	Opel Manta	1900, Luxus, Rallye, Sports Coupe	-75
033	Opel GT		-75
034	Opel Isuzu	Deluxe, Sport	76-79
398	Other automobile		-
399	Unknown automobile		-
401	Rendezvous		2002
402	Rainier		-
441	Terraza		-
499	Unknown Light Truck		-
998	Other vehicle		-
999	Unknown vehicle		-

19 CADILLAC

CODE	MODEL	INCLUDES	YEAR
003	Deville/Fleetwood (except Limousine)	Coupe de Ville, Sedan de Ville, Fleetwood, Brougham, Fleetwood, 60 Special, etc. d'Elegance, Concourse	all
004	Limousine	Fleetwood 75, Formal de Ville based	all
005	Eldorado	Biarritz, El-doro, Touring Coupe	67-on
006	Commercial Series	Ambulance/Hearse	all
009	Allanté		87-on
014	Seville	Elegante, STS	76-on
016	Cimarron	D'oro	82-88
017	Catera	RWD	97-on
018	CTS		2003
019	XLR		-
020	SRX		-
021	STS		-
022	DTS		-
398	Other automobile		-
399	Unknown automobile		-
421	Escalade		-
431	Ecalade ESV		-
480	Escalade EXT (Data years 2005 and earlier)		-
481	Escalade EXT (Data years 2006 and beyond)		-
498	Other Light Truck		-
499	Unknown Light Truck		-
998	Other vehicle		-
999	Unknown vehicle		-

20 CHEVROLET

CODE	MODEL	INCLUDES	YEAR
001	Chevelle/Malibu	Classic, Concours, S-3, Laguna, Nomad, 330, Greenbriar, Estate, Deluxe, SS 396/454	64-83
002	Impala/Caprice	Biscayne, Belair, Super Sport, Classic, Classic Brougham, Townsman, Brookwood, Kingswood	55-on
004	Corvette	Stingray	53-on
006	Corvair	Corvair Monza, 500, Corvair Spyder, Corsa	60-69
007	El Camino	Royal Knight, SS	59-on
008	Nova (-79)	Chevy II, LN, LE, Concours SS-350/396, Rally	62-79
009	Camaro	SS, RS, LT, Berlinafta, IROC-Z, Z28	67-on
010	Monte Carlo (RWD)	LS, SS, Aerocoupe, Landau	70-88
011	Vega	GT, Cosworth	71-77
012	Monza	Spyder, 2+2, Towne Coupe	75-80
013	Chevette	S, Scooter, CS	76-87
015	Citation	X-11, Citation II	80-85
016	Cavalier	CS, RS, Z24	82-on
017	Celebrity	CS, Eurosport, VR	82-on
019	Beretta/Corsica	GT	87-on
020	Lumina	(GM-10 based), Z-34, Euro	90-on
022	Cobalt		-
023	HHR		-
024	Traverse	LS, LT, LTZ	2009-on
025	Cruze	Applicable Body Types: 02,04	2011-on
026	Volt	Body Type 5	2011-on
031	Spectrum		85-on
032	Nova/GEO Prizm	CL, NUMMI-built vehicles	85-on
033	Sprint/GEO Sprint		85-on
034	GEO Metro	LSi, XFi	89-on
035	GEO Storm	GSi	85-on
036	Monte Carlo (FWD only)	Z34	95-on
037	Malibu		97-on
038	SSR		-
039	Aveo		-
398	Other automobile		-
399	Unknown automobile		-

20 CHEVROLET (continued)

401	S-10 Blazer, Blazer	S-10 p/u based	83-on
402	GEO Tracker	LSi	89-on
403	Geo Tracker		2002
404	Equinox		
421	Fullsize Blazer, Tahoe	K-series, fullsized p/u based	69-on
431	Suburban	All models	all
441	Astro Van	Minivan	85-on
442	Lumina APV		90-on
443	Ventura		97-on
444	Uplander		-
461	G-series van	Beauville, Chevy Van, Sport Van, G10-G30, Express	all
466	P-series van		all
470	Van derivative	Hi-cube, Parcel Van	all
471	S-10/T-10	4x4	82-on
472	LUV	Imported pickup	all
473	Colorado		-
481	C, K, R, V-series pickup	C10-C30, K10-K30, R10-R30, V10-V30, Silverado, C-K1500, 2500, 3500	all
482	Avalanche		2002
498	Other light truck		-
499	Unknown light truck		-
850	Truck based motorhome		-
881	Medium/Heavy CBE	C50/60/65, M60/65, H70/80/90, J70/80/90, Bison 90, all other CBE	all
882	Medium/Heavy COE low entry	T60/65, all other COE low entry	all
883	Medium/Heavy COE high entry	Titan 90, all other COE high entry	all
884	Medium/Heavy	Unknown engine location	-
890	Medium/Heavy COE	entry position unknown	-
898	Other medium/heavy truck		-
899	Unknown medium/heavy truck		-
950	Bus based motorhome		-
981	Bus	S-60 series	all
988	Other bus		-
989	Unknown bus		-
998	Other vehicle		-
999	Unknown vehicle		-

21 OLDSMOBILE

CODE	MODEL	INCLUDES	YEAR
001	Cutlass (RWD-only)	Supreme, S, LS, Salon Brougham, Vista Cruiser, F85 (thru 72), Rallye 350, Hurst Olds, 442, Calais, Classic (88)	62-88
002	Delta 88	Royale, Custom, Delta, Jetstar 88, Delmont 88, Starfire (thru 66), Custom Cruiser	all
003	Ninety-Eight	Regency, Luxury	all
005	Toronado	XSR, Trofeo, Brougham Custom	66-92
006	Commercial Series	Ambulance/Hearse	all
012	Starfire	SX,GT	75-80
015	Omega	All front wheel drive	75-85
016	Firenza	S, LS, SX, Cruiser, GT	82-88
017	Ciera	Cutlass Ciera, Brougham, ES	82-on
018	Calais	GT, ES, 500	85-91
020	Cutlass (FWD)	Supreme	88-on
021	Achieva	SC	92-on
022	Aurora		94-on
023	Intrigue		-
024	Alero		-
398	Other automobile		-
399	Unknown automobile		-
401	Bravada		91-on
441	Silhouette		90-on
498	Other light truck		-
499	Unknown light truck		-
998	Other vehicle		-
999	Unknown vehicle		-

22 PONTIAC

CODE	MODEL	INCLUDES	YEAR
001	Lemans Tempest (-79)	Safari, T-37, Luxury, Grand Sport, GTO (-73), GT-37, Sprint, Judge, Grand AM (73-75), Grand Lemans	62-79
002	Bonneville/Catalina/Parisiene	Brougham, Grand Safari, Safari, Grandville, 2+2 Executive, Starchief SE, SSE, SSEi, Parisienne	all
005	Fiero	2M4, 2M6, GT, SE	84-88
008	Ventura	II, SJ, Sprint, GTO (74-on), Custom	71-77
009	Firebird/Trans AM	Esprit, Formula, GTA, Redbird, Yellowbird, Skybird, SE	67-on
010	Grand Prix (RWD)	J, LJ, SJ, Brougham, 2+2	63-87
011	Astre	Safari, SJ, Custom	75-77
012	Sunbird (thru 80)	Safari, Sport, Formula	76-80
013	T-1000/1000		81-87
015	Phoenix	LJ, SJ	77-84
016	J2000/2000/Sunbird Sunfire	Sunbird (84-on), LE, SE, GT, Convertible, GT/SE	82-on
017	6000	STE, SE, LE	82-on
018	Grand AM	SE,LE	all
019	G5		-
020	Grand Prix (FWD)	SE	88-on
022	G6		-
023	Solstice		-
024	G8	Includes GT	2008-on
025	G3		2009-on
031	Lemans (88-on)	SE, Tempest (Canadian)	88-on
032	Vibe	Includes GT, AWD	2003-on
398	Other automobile		-
399	Unknown automobile		-
401	Aztek		2001
402	Vibe		2003
403	Torrent		-
441	Trans Sport		90-on
498	Other light truck		-
499	Unknown light truck		-
998	Other vehicle		-
999	Unknown vehicle		-

23 GMC

CODE	MODEL	INCLUDES	YEAR
007	Caballero/Sprint	Sierra Madre del Sur, SP	65-on
008	Arcadia		-
398	Other automobile		-
399	Unknown automobile		-
401	Jimmy/Typhoon	S15 based	83-on
402	Terrain	SLE, SLT	2009-on
421	Fullsize Jimmy Yukon	fullsize pickup based	all
431	Suburban	all models	all
441	Safari (minivan)		86-on
461	G-series van	Rally Van, Vandura, G15-G35, Savana	all
466	P-series van		all
470	Van derivative	Hicube, parcel van, Value Van, Magna Van	all
471	S15fT15/Sonoma		82-on
472	Canyon		-
481	C, K, R, V-series pickup	C15-35, K15-35, R15-35, V15-35, Sierra	all
498	Other light truck		-
499	Unknown light truck		-
850	Truck based motorhome		-
881	Medium/Heavy CBE	W5000/6000/7000 series, Brigadier/General models	all
882	Medium/Heavy COE low entry	W6000/W7000, all other COE, low entry	all
883	Medium/Heavy COE high entry	Astro 95, all other COE, high entry	all
884	Medium/Heavy	Unknown engine location	-
890	Medium/Heavy COE	entry position unknown	-
898	Other medium/heavy truck		-
899	Unknown medium/heavy truck		-
950	Bus based motorhome		-
981	Bus	B6000	all
988	Other Bus		-
989	Unknown bus		-
998	Other vehicle		-
999	Unknown vehicle		-

24 SATURN

CODE	MODEL	INCLUDES	YEAR
001	SL	SL1, SL2, SL3	91-on
002	SC	SC1,SC2	91-on
003	SW	SW1, SW2	93-on
004	EV1	(electric vehicle)	97-on
005	LS		2000
006	LW		2000
007	Ion		-
008	Sky		-
009	Aura		-
010	Outlook	XE, XR (Body Type = S/W)	
011	Astra	XE, XR, Sport (Body Types: 03 & 05)	
398	Other automobile		-
399	Unknown automobile		-
401	Vue		2002
441	Relay		-
498	Other light truck		-
499	Unknown light truck		-
998	Other vehicle		-
999	Unknown vehicle		-

25 GRUMMAN

CODE	MODEL	INCLUDES	YEAR
441	LLV	Postal vehicle	all
442	Step-in van	Multi-stop, step van	all
498	Other light truck		-
499	Unknown light truck		-
850	Truck based motorhome		-
881	Medium/Heavy CBE		all
882	Medium/Heavy COE low entry		all
883	Medium/Heavy COE high entry		all
884	Medium/Heavy Unknown engine location		-
890	Medium/Heavy COE entry position unknown		-
898	Other medium/heavy truck		-
899	Unknown medium/heavy truck		-
983	Bus-flat front, rear engine	Transit	all
988	Other bus		-
989	Unknown bus		-
998	Other vehicle		-
999	Unknown vehicle		-

29 OTHER DOMESTIC MANUFACTURER

CODE	MODEL	INCLUDES	YEAR
001	Studebaker/Avanti	Lark, Gran Turismo, Hawk, Cruiser, all associated subseries	-66
002	Checker	Marathon, Superba, Taxi, Aerobus	-82
398	Other make	Desoto, Excaliber, Stutz, Hudson, Packard, Consulier	all
399	Unknown make		-
498	Other Light Truck		-
898	Other Medium/Heavy Truck		-
988	Other Bus		-

30 VOLKSWAGEN

CODE	MODEL	INCLUDES	YEAR
031	Karmann Ghia		-74
032	Beetle 1300/1500	flat windshield	-77
033	Super Beetle	distinguished by curved windshield	71-80
034	411/412	Squareback/Fastback	71-74
035	Squareback/Fastback	Type 3, 1600	-74
036	Rabbit	L, GTI, Sport, LS, Custom, DL, Deluxe	75-84
037	Dasher		74-81
038	Scirocco	16V	75-88
040	Jetta	GL, GLI	80-92
041	Quantum	Synco	82-88
042	Golf	Synco, GTI, Cabriolet, GT, GL	85-92
043	Rabbit pickup	car based pickup	80-83
044	Fox		87-on
045	Corrado		89-on
046	Passat		90-on
047	Jetta III		93-on
048	Golf III		93-on
049	New Beetle		1988
050	Phaeton		-
051	EOS		-
398	Other automobile		-
399	Unknown automobile		-
401	The Thing (181)		73-75
402	Tiguan		2008-on
421	Touareg		-
441	Vanagon/Camper	Bus, Kombi, Van	all
442	Eurovan		92-on
443	Routan	S, SE, SEL Premium/RSE	2009-on
498	Other light truck		-
499	Unknown light truck		-
998	Other Vehicle		-
999	Unknown vehicle		-

31 ALFA ROMEO

CODE	MODEL	INCLUDES	YEAR
031	Spider	All roadsters, Veloce, 1750/2000 roadsters	all
032	Sports Sedan	All 4 door sedans Milano (86), Giulia, Super, Berlina, Alfetta, 1750/2000 sedans	all
033	Sprint Veloce	All 2-door coupes Alfetta GT, 1750/2000 GTV, Sprint GT	all
034	GTV-6		81-on
035	164		89-on
398	Other automobile		-
399	Unknown automobile		-
998	Other vehicle		-
999	Unknown vehicle		-

32 AUDI

CODE	MODEL	INCLUDES	YEAR
031	Super 90		70-72
032	100/A6	S, LS, GL, Quattro (89 on)	70-77 89 on
033	Fox		74-79
034	4000	Quattro, Coupe GT, CS, S	80-88
035	5000	Quattro, CS, S, Turbo	78-88
036	80/90	Quattro	88-95
037	200	Quattro	88-92
038	V-8 Quattro		90-94
039	Coupe Quattro		90-93
040	S4/S6		93-on
041	Cabriolet		94-on
042	A4		96-on
043	A3		96-on
044	A8		96-on
045	TT		2000
046	S8		2001
047	Allroad		2001
049	A5		-
050	R8		2008-on
398	Other automobile		-
399	Unknown automobile		-
401	Q7		-
402	Q5		
498	Other Light Truck		
998	Other vehicle		-
999	Unknown vehicle		-

33 AUSTIN/AUSTIN HEALEY

CODE	MODEL	INCLUDES	YEAR
031	Marina	GT	all
032	America		all
033	Healey Sprite		all
034	Healy 3000	Healy 100	all
035	Mini		all
398	Other automobile		-
399	Unknown automobile		-
998	Other vehicle		-
999	Unknown vehicle		-

34 BMW

CODE	MODEL	INCLUDES	YEAR
031	1600, 2000	Tii, 1800, 2000S	-76
032	Coupe	2800CS, 3.0CS	69-76
033	Bavaria Sedan	2500, 2800	69-74
034	3-series	318i, 318ti, 320i, 325e, 325es, 325i, 328, M3	77-on
035	5-series	524i, 528i, 530i, 533i, 535i, TD 525i (wagon), M5, 540iA, 540i	75-on 77-on
036	6-series	630, 633, 635, csi, M6	-
037	7-series	733i, 735i, L7, 740i, 750iL	78-on
038	8-series	850	90-on
039	Z3		96-on
040	Z8		-
041	V5		-
042	Z4		-
043	1 Series	128i, 135i	2008-on
044	X6		2008-on
398	Other automobile		-
399	Unknown automobile		-
401	X5	4WD	2000
402	X3		-
498	Other Light Truck		-
499	Unknown Light Truck		-

Motorcycles

CODE	MODEL	
701	0-50cc	-
702	51-124cc	-
703	125-349cc	-
704	350-449cc	-
705	450-749cc	-
706	750cc-over	-
709	Unknown cc	-
799	Unknown motored cycle	-
998	Other Vehicle	-
999	Unknown vehicle	-

35 NISSAN/DATSUN

CODE	MODEL	INCLUDES	YEAR
031	F10		77-78
032	200/240 SX		78-on
033	1200/210/B210	Honeybee	71-82
034	Z-car, ZX	240/260/280Z, 300 ZX, Turbo, 2+2	70-on
035	310		79-82
036	510	PL	68-73 78-81
037	610	PL	73-76
038	710	PL	74-77
039	810/Maxima		77-on
040	Roadster	SPL 311, SRL 311, 1600, 2000, convertible	-70
041	PL 411, RL 411		-67
042	Stanza	XE	82-92
043	Sentra		83-on
044	Pulsar	NX, EXA (86-on)	83-90
045	Micra		87-on
046	NX1600/2000		92-on
047	Altima		93-on
048	350Z		-
049	Murano		-
050	Versa		
051	Rogue	Includes S, SL	2008-on
052	Cube		2010-on
053	GT-R		2009-on
055	Leaf		2011-on
398	Other automobile		-
399	Unknown automobile		-
401	Pathfinder	MPV, 4 x 4	86-on
402	Xterra		2000
403	Juke		2011-on
421	Armada		-
441	Van	XE, GXE	87-on
442	Axxess		89-90
443	Quest		93-on
444	Altra EV	Electric vehicle	1998-2005
445	NV	Body Types 21 & 22	2011-on

35 NISSAN/DATSUN (continued)

471	Datsun/Nissan Pickup	PL620, King Cab, Hardbody	73-on
473	Titan (Data years 2005 and earlier)		-
481	Titan (Data years 2006 and beyond)		-
498	Other light truck	Patrol	(1960)
499	Unknown light truck		-
883	Medium/Heavy COE	high entry	all
898	Other medium/heavy truck		all
899	Unknown medium/heavy truck		-
998	Other vehicle		-
999	Unknown vehicle		-

36 FIAT

CODE	MODEL	INCLUDES	YEAR
031	124 (Coupe/Sedan)	Sport	67-75
032	124 Spider/Racer	Spider 2000/1500	68-83
033	Brava - 131		75-82
034	850 (Coupe/Spyder)		67-73
035	128		72-79
036	X-1/9		75-83
037	Strada		79-83
398	Other automobile	600, 1100	all
399	Unknown automobile		-
882	Medium/Heavy COE	low entry	all
883	Medium/Heavy COE	high entry	all
890	Medium/Heavy COE	entry position unknown	-
898	Other medium/heavy truck		all
899	Unknown medium/heavy truck		-
998	Other vehicle		-
999	Unknown vehicle		-

37 HONDA (ACURA: See 54)

CODE	MODEL	INCLUDES	YEAR
031	Civic/CRX	1300, 1500, CVCC, DX, EX, VX, S, Si, HF, 4WD Wagon, del Sol	73-on
032	Accord	LX, CVCC, SE-i, LX-i, EX Wagon	76-on
033	Prelude	Si	80-on
034	600	Coupe, Sedan	all
035	S2000		-
037	Insight		-
038	FCX		2004-on
039	Fit		-
398	Other automobile	all Hondas not listed above	-
399	Unknown automobile		-
401	Passport		94-on
402	CR-V		-
403	Element		-
421	Pilot		-
441	Odyssey		95-on
471	Datsun/Nissan PU Frontier		-
498	Other Light Truck		94-on
499	Unknown Light Truck		94-on

Motorcycles

CODE	MODEL	
701	0-50cc	-
702	51-124cc	-
703	125-349cc	-
704	350-449cc	-
705	450-749cc	-
706	750cc-over	-
709	Unknown cc	-

37 HONDA (continued)***All Terrain Cycles/Vehicles******(Model codes 731–739 are designed solely for off-road use)***

CODE	MODEL	
731	0-50cc	-
732	51-124 cc	-
733	125-349 cc	-
734	350cc or greater	-
739	Unknown cc	-
798	Other Motorcycle	-
799	Unknown motored cycle	-
998	Other vehicle	-
999	Unknown vehicle	-

38 ISUZU

CODE	MODEL	INCLUDES	YEAR
031	I-Mark	S, RS, Turbo	85-89
032	Impulse	Turbo, RS	84-on
033	Stylus		90-an
398	Other automobile		-
399	Unknown automobile		-
401	Trooper/Trooper II	Deluxe, LS	84-on
402	Rodeo		91-on
403	Amigo		89-94
404	Vehicross		1999
405	Axiom		2000
421	Ascender		-
441	Oasis		96-on
471	P'up (pickup)	4 x 4	all
473	i-280/i-290	S, LS, Luxury	2006-on
474	i-350/i-370	LS, Limited, S	2006-on
498	Other light truck		-
499	Unknown light truck		all
881	Medium/Heavy CBE		all
882	Medium/Heavy COE	low entry	all
883	Medium/Heavy COE	high entry	all
884	Medium/Heavy	unknown engine location	-
890	Medium/Heavy COE	entry position unknown	-
898	Other medium/heavy truck		-
899	Unknown medium/heavy truck		-
950	Bus based motorhome		-
981	Bus Conventional front engine		-
982	Bus Front engine/flat front		-
983	Bus Rear engine/flat front		-
988	Other bus		-
989	Unknown bus		-
998	Other vehicle		-
999	Unknown vehicle		-

39 JAGUAR

CODE	MODEL	INCLUDES	YEAR
031	XJ-S Coupe		76-on
032	XJ6/12 Sedan/Coupe L, XJ, C, 340/420 Sedan		all
033	XKE V12, Roadster, 120, 2 + 2		all
034	X100		97-on
035	X-Type		-
398	Other automobile		-
399	Unknown automobile		-
998	Other vehicle		-
999	Unknown vehicle		-

40 LANCIA

CODE	MODEL	INCLUDES	YEAR
031	Beta Sedan - HPG		80
032	Beta Coupe - Zagato		82
033	Scorpion		78
398	Other automobile		-
399	Unknown automobile		-
998	Other vehicle		-
999	Unknown vehicle		-

41 MAZDA

CODE	MODEL	INCLUDES	YEAR
031	RX2		72-74
032	RX3		72-78
033	RX4		74-78
034	RX7	S, GS, GSL, SE	79-on
035	323/GLC/Protege	DX, Protege (90-on)	77-on
036	Cosmo		76-78
037	626	GT, GS, GSL, SE	79-on
038	808		72-77
039	Mizer		76
040	R-100		-72
041	616/618		-72
042	1800		-72
043	929		88-on
044	MX-6	Turbo	88-on
045	Miata		90-on
046	MX-3		92-on
047	Millenia		95-on
048	MP3		-
049	RX-8		-
050	Mazda 6		-
051	Mazda 3		-
052	Mazda 5		-
053	CX-7		-
054	CX-9		-
398	Other automobile		-
399	Unknown automobile		-
401	Navajo		91-on
402	Tribute		-
441	MPV		89-on
471	Mazda pickup	B-2000, B-2200, B-2600, B-4000, Cab Plus, SE-5, LX	all
498	Other light truck		-
499	Unknown light truck		-
998	Other vehicle		-
999	Unknown vehicle		-

42 MERCEDES BENZ

CODE	MODEL	INCLUDES	YEAR
031	200/220/230/240/250/ 260/280/300/320/420	Sedan and 5 passenger C only, SE, CD, D, SD, TD, CE, E. DOES NOT include 280 SE (75 on), 300 SD - see code 037	all
032	230/280 SL	2 seater only	all
033	300/350/380/450/500 SL, 560 SL	2 seater only, 300/500 SL (90-on)	all
034	350/380/420/450/560	SLC	all
035	280/300 SEL	TD, TD-T, CDT	all
036	380/420/450/500/560 SEL and 500/560 SEC/ 350 SDL/300 SDL		all
037	300 SE/380/450 SE	280 S, 280 SE (75 on), 300 SD Sedan, 350 SD	all
038	600, 6.9 Sedan	Pullman	all
039	190	D, TD, 2.3, 2.5	all
040	300	CE Cabriolet	93-on
041	400/500E		92-on
042	220/280C		94-on
043	S Class		-
044	SL Class		-
045	SLK		-
046	CL		-
047	CLK		-
048	E		-
049	SLR McLaren		-
050	R-Class		-
051	CLS-Class		-
398	Other automobile		-
399	Unknown automobile		-
401	M		-
402	G Class		-
470	Van derivative	Kurbstar	82-on
498	Other light truck		-
499	Unknown light truck		-
881	Medium/Heavy CBE		all
882	Medium/Heavy COE	low entry	all
883	Medium/Heavy COE	high entry	all

42 MERCEDES BENZ (continued)

884	Medium/Heavy	Unknown engine location	-
890	Medium/Heavy COE	entry position unknown	-
898	Other medium/heavy truck		-
899	Unknown medium/heavy truck		-
950	Bus based motorhome		-
981	Medium bus		all
988	Other bus		-
989	Unknown bus		-
998	Other vehicle		-
999	Unknown vehicle		-

43 MG

CODE	MODEL	INCLUDES	YEAR
031	Midget	MKIII, 1500	-79
032	MGB		76-79
033	MGB	GT	67-75
034	MGA		all
035	TA/TC/TD/TF		all
036	MGC	GT	-69
398	Other automobile	Sport Sedan	-
399	Unknown automobile		-
998	Other vehicle		-
999	Unknown vehicle		-

44 PEUGEOT

CODE	MODEL	INCLUDES	YEAR
031	304		71-73
032	403		-67
033	404		-70
034	504/505	STI, STX, Turbo, S, GL, GLS, Liberte, Station Wagon	70-91
035	604	SL, D	77-84
036	405	Mi-16	89-91
398	Other automobile		-
399	Unknown automobile		-

Motorcycles

CODE	MODEL	
701	0-50cc	-
702	51-124cc	-
709	Unknown cc	-
799	Unknown motored cycle	-
998	Other vehicle	-
999	Unknown vehicle	-

45 PORSCHE

CODE	MODEL	INCLUDES	YEAR
031	911	L, S, E, T, SC, Carrera, Slophenose, Speedster, Panorama	all
032	912	E, T	-69
033	914	S, 1.8, 2.0, 914/6	70-76
034	924	Turbo, S	77-88
035	928	S	78-on
036	930	Turbo	79
037	944	Turbo, S	83-91
038	959		89-94
039	968		92-95
040	986 Boxter		-
041	Cayman		-
398	Other automobile	Spyder, Speedster, 356	-
399	Unknown automobile		-
421	Cayenne		-
998	Other vehicle		-
999	Unknown vehicle		-

46 RENAULT

CODE	MODEL	INCLUDES	YEAR
031	LeCar	R5	76-83
032	Dauphine/10/R-8/ Caravelle	all models	-71
033	12	R12L, R12TL	72-77
034	15	R15, R15TL	73-76
035	16	R16	69-72
036	17	R17, Gordini Coupe, R17TL	73-80
037	RI 8i	Sportwagon	81-on
038	Fuego	TL, TS, GTL, GTS, Turbo	82-85
039	Alliance/Encore, GTA, Convertible	L, DL, Limited, X-37	83-on
041	Alpine	GT	87-on
044	Medallion	DL, LX	87 only
045	Premier		87 only
398	Other automobile		-
399	Unknown automobile		-
998	Other vehicle		-
999	Unknown vehicle		-

47 SAAB

CODE	MODEL	INCLUDES	YEAR
031	99/99E/900	S, Turbo, Cabriolet	all
032	Sonnet	II, III, V-4	68-74
033	95/96/97		-73
034	9000	S, Turbo, CS (93-on)	85-on
035	9-3		-
036	9-5		-
037	9-2X		-
398	Other automobile	Monte Carlo 850	all
399	Unknown automobile		-
401	9-7X		-
498	Other Light Truck		-
499	Unknown light truck		-
998	Other vehicle		-
999	Unknown vehicle		-

48 SUBARU

CODE	MODEL	INCLUDES	YEAR
031	DL/FE/G/GF/GL/GLF/ STD/Loyale	4 wheel drive, Turbo	72-94
032	Star		70-71
033	360		69-70
034	Legacy	Brighton, Outback, Outback II	89-on
035	XT, XT6	4WD Turbo, convertible, DL	86-on
036	Justy	DL, GL	87-94
037	SVX		92-on
038	Impreza		93-on
043	Brat	DL, GL	78-on
044	Baja		-
045	Outback		-
398	Other automobile		-
399	Unknown automobile		-
401	Forester		-
402	B9 Tribeca		-
498	Other Light Truck		-
499	Unknown Light Truck		-
998	Other vehicle		-
999	Unknown vehicle		-

49 TOYOTA

CODE	MODEL	INCLUDES	YEAR
031	Corona	Mark 11, Custom, 1900, 2000, Deluxe	-82
032	Corolla	1100, 1200, 1600, SR-5, LE, Deluxe, Custom, FX16	69-85 86-on
033	Celica	1900, 2000, GT, ST, GTS	71-on
034	Supra	Celica Supra, Soarer	79-92
035	Cressida		78-92
036	Crown	2300, 2600	-71
037	Carina	2000	72-73
038	Tercel	Corolla Tercel, 4WD Wagon	80-on
039	Starlet		81-84
040	Camry	LE, Deluxe, XLE, Coupe	83-on
041	MR-2		85-95
042	Paseo		92-on
043	Avalon		95-on
044	Solara		-
045	Echo		-
046	Prius		-
048	Scion XA		-
049	Scion XB		-
050	Scion TC		-
051	Yaris		-
052	Scion XD	4-door hatchback	2008-on
053	Venza		2009-on
398	Other automobile	2000 GT Coupe (1960s)	all
399	Unknown automobile		-
401	4-Runner		85-on
402	RAV-4		96-on
403	Highlander		-
404	Matrix		-
405	FJ Cruiser		-
421	Landcruiser		76-on
422	Sequoia		-
441	Minivan/Previa(84-on
442	Sienna		-

49 TOYOTA (continued)

471	Pickup	SR-5, Extra Cab, Sport, LN44, Chinook, Wonder Wagon	74-on
472	Takoma		95-on
481	T-100		93-on
482	Tundra		
498	Other light truck		-
499	Unknown light truck		-
998	Other vehicle		-
999	Unknown vehicle		-

50 TRIUMPH

CODE	MODEL	INCLUDES	YEAR
031	Spitfire	I, II, III, IV, 1500	-81
032	GT-6	MK3	67-73
033	TR4	TR2, TR3, TR4A	-68
034	TR6		69-76
035	TR7/8		75-81
036	Herald	Vitesse	60-74
037	Stag		60-74
398	Other automobile	2000, 1200 series	-
399	Unknown automobile		-

Motorcycles

CODE	MODEL	
701	0-50cc	-
702	51-124cc	-
703	125-349cc	-
704	350-449cc	-
705	450-749cc	-
706	750cc-over	-
709	Unknown cc	-
799	Unknown motored cycle	-
998	Other vehicle	-
999	Unknown vehicle	-

51 VOLVO (includes Volvo/White and Volvo/GM Heavy Trucks)

CODE	MODEL	INCLUDES	YEAR
031	122	S	58-68
032	142/144/145	S, E, GL, GLS, Deluxe	67-74
033	164	S, E	69-75
034	240/242/244/245	DL, GL, GLE, GLT, Deluxe	75-on
035	262/264/265	GL	76-82
036	1800	E, S, ES	60-73
037	P-544		47-65
038	760 780	Turbo	83-90 87-92
039	740	GLE, GE, Turbo, GL	85-92
040	940	BLE, Turbo, SE	91-on
041	960		92-on
042	850	GLT, Wagon	93-on
043	70 Series		-
044	90 Series		-
045	80 Series		-
046	40 Series	S40,V40	-
047	60 Series		-
048	V50		-
049	C30	1.0, 2.0, TS, R-Design	2008-on
050	XC60		2008-on
398	Other automobile		-
399	Unknown automobile		-
401	XC90		-
881	Medium/Heavy CBE		all
882	Medium/Heavy COE	low entry	all
883	Medium/Heavy COE	high entry	all
884	Medium/Heavy	unknown engine location	-
890	Medium/Heavy COE	entry position unknown	-
898	Other medium/heavy truck		all
899	Unknown medium/heavy truck		-
950	Bus based motorhome		-
981	Medium bus		all
988	Other bus		all
989	Unknown bus		-

51 VOLVO (continued)

998	Other vehicle	-
999	Unknown vehicle	-

52 MITSUBISHI

CODE	MODEL	INCLUDES	YEAR
031	Starion	2+2, LE, Turbo	83-90
032	Tredia	L, LS, Turbo	83-88
033	Cordia	L, Turbo	83-88
034	Galant	ECS, Sigma (thru-88)	85-on
035	Mirage	L, Turbo	85-on
036	Precis		90-on
037	Eclipse		90-on
038	Sigma		89-90
039	3000 GT		91-on
040	Diamante		92-on
046	Lancer		-
398	Other automobile		-
399	Unknown automobile		-
401	Montero	Sport	85-on
402	Outlander		-
403	Endeavor		-
441	Minivan	LS	87-on
442	Expo	LRV, Sport	92-95
471	Pickup	Mighty Max, SPX, 4x4	all
472	Raider/Durocross		-
498	Other light truck		-
499	Unknown light truck		-
882	Medium/Heavy COE	low entry, FUSO FE	all
898	Other medium/heavy truck		-
899	Unknown medium/heavy truck		-
950	Bus based motorhome		-
981	Bus Conventional front engine		all
982	Bus Front engine/flat front		all
983	Bus Rear engine/flat front		all
988	Other bus		-
989	Unknown bus		-
998	Other vehicle		-
999	Unknown vehicle		-

53 SUZUKI

CODE	MODEL	INCLUDES	YEAR
031	SA310	GLX	86-on
034	Swift	GTi,GTX	89-on
035	Esteem		-
036	Aerio		-
037	Forenza		-
038	Verona		-
039	Reno		-
040	SX4		-
398	Other automobile		-
399	Unknown automobile		-
401	Samurai	Standard, Deluxe	85-95
402	Sidekick		89-on
403	X-90		96-on
404	Gvand Vitara		-
405	XL7		-
481	Equator		2009-on
498	Other light truck		-
499	Unknown light truck		-

Motorcycles

CODE	MODEL	
701	0-50cc	-
702	51-124cc	-
703	125-349cc	-
704	350-449cc	-
705	450-749cc	-
706	750cc-over	-
709	Unknown cc	-

53 SUZUKI (continued)***All Terrain Cycles/Vehicles***

CODE	MODEL	INCLUDES	YEAR
731	0-50cc	includes all ATCs/ATVs	-
732	51-124	designed solely for off-road use.	-
733	125-349cc		-
734	350cc or greater		-
739	Unknown cc		-
798	Other Motored Cycle		-
799	Unknown motored cycle		-
998	Other vehicle		-
999	Unknown vehicle		-

54 ACURA

CODE	MODEL	INCLUDES	YEAR
031	Integra	RS, LS	86-on
032	Legend/RL		86-on
033	NSX	NSX -T	91-on
034	Vigor/TL	TL2.5/TL3.2	92-on
035	CL	Coupe	96-on
038	RSX		-
039	TSX		-
040	ZDX	Body Type = 05/5-door/4-door hatchback	2010-on
398	Other automobile		-
399	Unknown automobile		-
401	SLX		96-on
402	RDX		-
421	MDX		-
498	Other Light Truck		-
499	Unknown Light Truck		-
998	Other vehicle		-
999	Unknown vehicle		-

55 HYUNDAI

CODE	MODEL	INCLUDES	YEAR
031	Pony		84-88
032	Excel	GL, GLS	84-94
033	Sonata		89-on
034	Scoupe		91-95
035	Elantra		92-on
036	Accent		95-on
037	Tiburon		-
038	XG300		-
039	Azera		-
040	Equus		2008-on
041	Genesis	3.8, 4.6	2009-on
398	Other automobile		-
399	Unknown automobile		-
401	Santa Fe		-
402	Tuscon		-
403	Veracruz		-
441	Entourage		-
498	Other Light Truck		-
499	Unknown Light Truck		-
998	Other vehicle		-
999	Unknown vehicle		-

56 MERKUR

CODE	MODEL	INCLUDES	YEAR
031	XR4Ti	Turbo	85-89
032	Scorpio	Tu rbo	87-90
398	Other automobile		-
399	Unknown automobile		-
998	Other vehicle		-
999	Unknown vehicle		-

57 YUGO

CODE	MODEL	INCLUDES	YEAR
031	GV	GVX, Cabriolet	86-92
398	Other automobile		-
399	Unknown automobile		-
998	Other vehicle		-
999	Unknown vehicle		-

58 INFINITI

CODE	MODEL	INCLUDES	YEAR
031	M30		90-92
032	Q45		90-on
033	G20		91-96
034	J30		93-on
035	I30		96-on
036	I35		-
037	G35		-
038	M45		-
039	FX35/45		-
040	EX35	Includes Journey	2008-on
398	Other automobile		-
399	Unknown automobile		-
401	T30		97-on
421	QX56		-
498	Other Light Truck		97-on
499	Unknown Light Truck		97-on
998	Other vehicle		-
999	Unknown vehicle		-

59 LEXUS

CODE	MODEL	INCLUDES	YEAR
031	ES-250/ES-300		90-on
032	LS-400		90-on
033	SC-300/SC-400	2 door Coupe	92-on
034	GS-300		94-on
035	IS-300		-
036	SC 430		2002
398	Other automobile		-
399	Unknown automobile		-
401	RX300		-
402	GX470		-
403	RX330/350/400h	Hybrid, Thundercloud, Mark Levinson Package	2004-on
421	LX-450		96-on
498	Other light Truck		96-on
499	Unknown Light Truck		96-on
998	Other vehicle		-
999	Unknown vehicle		-

60 DAIHATSU

CODE	MODEL	INCLUDES	YEAR
031	Charade		90-92
398	Other automobile		-
399	Unknown automobile		-
401	Rocky		90-92
498	Other light truck		-
499	Unknown light truck		-
998	Other vehicle		-
999	Unknown vehicle		-

61 STERLING

CODE	MODEL	INCLUDES	YEAR
031	827S	Li	86-91
398	Other automobile		-
399	Unknown automobile		-
998	Other vehicle		-
999	Unknown vehicle		-

62 LAND ROVER

CODE	MODEL	INCLUDES	YEAR
401	Discovery (LR)		94-on
402	Defender 90 (LR)		94-on
421	County LWB (RR)/County Classis (RR)		all
422	Defender 90 (LR), 4.0 SE (RR), and Freelander		-
423	LR3		-
424	LR2		-
498	Other Light Truck		all
499	Unknown Light Truck		all
998	Other vehicle		-
999	Unknown vehicle		-

63 KIA

CODE	MODEL	INCLUDES	YEAR
031	Sephia		all
032	Spectra		-
033	Rio		-
034	Optima		-
035	Amanti		-
036	Rondo		-
037	Soul		2009-on
038	Forte		2010-on
398	Other automobile		-
399	Unknown automobile		-
401	Sportage		96-on
402	Sorrento		-
421	Borrego	EX, LX (Body Type = 15/Large Utility)	2009-on
441	Sedona		-
498	Other Light Truck		-
499	Unknown Light Truck		-
998	Other vehicle		-
999	Unknown vehicle		-

64 DAEWOO

CODE	MODEL	INCLUDES	YEAR
031	Lanos		-
032	Nubira		-
033	Leganza		-
398	Other Automobile		-
399	Unknown Automobile		-
999	Other Vehicle		-

65 MINI

CODE	MODEL	INCLUDES	YEAR
031	Cooper		-

65 SMART

CODE	MODEL	INCLUDES	YEAR
031	ForTwo	Pure & Passion	-
398	Other automobile		-
399	Unknown automobile		-

69 OTHER FOREIGN

CODE	MODEL	INCLUDES	YEAR
031	Aston Martin	Lagonda, Vantage, Volante, Saloon	all
032	Bricklin		all
033	Citreon		all
034	Delorean		all
035	Ferrari		all
036	Hillman		all
037	Jensen	Healy	all
038	Lamborghini	Countach 5000S, Jalpa	all
039	Lotus	Europe, Esprit	all
040	Maserati	Biturbo	all
041	Morris	Minor	all
042	Rolls Royce/Bentley	Cloud/shadow series	all
044	Simca		all
045	Sunbeam		all
046	TVR		all
048	Desta		all
049	Reliant		all
052	Bertone	X/19	all
053	Lada		all
054	Mini Cooper		
398	Other make	Morgan, Singer	all
399	Unknown make		-
498	Other light truck		-

MAKES 70 to 79: See ["Classification of Motored Cycles and All Terrain Vehicles / Cycles"](#).

81 DIAMOND REO / REO

CODE	MODEL	INCLUDES	YEAR
850	Medium/Heavy Truck Based Motorhome		-
881	Medium Heavy - CBE		all
882	Medium/Heavy – COE/Low entry		-
883	Medium/Heavy – COE/High entry		-
884	Medium/Heavy – Unknown Engine Location		-
890	Medium/Heavy – COE/Entry Position Unknown		-
898	Medium/Heavy – Other		-
899	Unknown Medium/Heavy Truck		-

82 FREIGHTLINER/WHITE

CODE	MODEL	INCLUDES	YEAR
461	Sprinter/Advantage		-
470	M-Line Walk-in Van		-
498	Other Light Truck		-
499	Unknown Light Truck		-
850	Truck based motorhome		-
881	Medium Heavy - CBE		all
882	Medium/Heavy COE low entry		all
883	Medium/Heavy COE high entry		all
884	Medium/Heavy unknown engine location		-
890	Medium/Heavy COE entry position unknown		-
898	Other medium/heavy truck		all
899	Unknown medium/heavy truck		-
981	Conventional bus		all
982	Bus-flat front, front engine		all
983	Bus-flat front, rear engine		all
988	Other bus		-
989	Unknown bus		-
999	Unknown vehicle		-

84 INTERNATIONAL HARVESTER

CODE	MODEL	INCLUDES	YEAR
421	Scout	Scout II, Utility pickup, SS-2, Roadstar, 800 series, Traveler, Terra Traveltop	all
431	Travelall	1010-1210, 100-200	all
466	Multistop Van	Metro RM, 120-160, MS 1210, MS 1510	all
481	Pickup	R-100-500, 900A-1 500C/D, 1010-1510	all
498	Other light truck		-
499	Unknown light truck		-
850	Truck based motorhome		-
881	Medium Heavy - CBE	Loadstar/Fleetstar, Paystar, CBE Transtar, 4200, S-series Mixer	all
882	Medium/Heavy COE low entry	CO, VCO, DCO, 190-1950, Cargostar, LFM, 5370	all
883	Medium/Heavy COE high entry	DCO, DCOT, UCO, VCOT, 405-series, COE Transtar, Unistar, Conco 707B, 9600	all
884	Medium/Heavy	unknown engine location	-
890	Medium/Heavy COE	entry position unknown	-
898	Other medium/heavy truck	firetruck-RI4O-R301, C08190	all
899	Unknown medium/heavy truck		-
950	Bus based Motorhome		all
981	Conventional bus	RI53-1853 - Loadstar, 1603-1853	all
982	Bus-flat front, front engine	173FC,183FC	all
983	Bus-flat front, rear engine	183RE, 193RE-transit	all
988	Other bus		-
989	Unknown bus		-
998	Other vehicle		-
999	Unknown vehicle		-

MAKES 85 to 98: See [“Classification for Medium/Heavy Trucks and Buses”](#).

99 UNKNOWN MAKE

CODE	MODEL	INCLUDES	YEAR
399	Unknown automobile		-
499	Unknown light truck		-
799	Unknown motored cycle		-
899	Unknown medium/heavy truck		-
988	Other bus		-
989	Unknown bus		-
998	Other vehicle		-
999	Unknown vehicle		-

Classification for Motored Cycles and All Terrain Vehicles / Cycles

Vehicle Make	MC	ATC	ATV	Make Code
BMW	x			34
Honda	x	x	x	37
Peugeot	x			44
Triumph	x			50
Suzuki	x	x	x	53
BSA	x			70
Ducati	x			71
Harley-Davidson	x			72
Kawasaki	x	x	x	73
Moto-Guzzi	x		x	74
Norton	x			75
Yamaha	x	x	x	76
Other make moped	x			78
Other make motorized cycle	x	x	x	79
Unknown make				99

The following model codes are used for all manufacturers of motored cycles and all terrain vehicles/cycles:

Motored Cycles:		All Terrain Vehicles/Cycles:	
0-50cc	701	0-50cc	731
51-124cc	702	51-124cc	732
125-349cc	703	125-349cc	733
350-449cc	704	350cc or greater	734
450-749cc	705	Unknown cc	739
750cc-or greater	706		
Unknown cc	709		
All Cycles:			
Other motored cycle	798		
Unknown motored cycle	799		
Other vehicle	998		

Classification for Medium/Heavy Trucks and Buses

Vehicle Make	Truck	Bus	Make Code
AM General	x	x	03
Dodge	x	x	07
Ford	x	x	12
Chevrolet	x	x	20
GMC	x	x	23
Grumman	x	x	25
Nissan/Datsun	x		35
Fiat	x		36
Isuzu	x	x	38
Mercedes Benz	x	x	42
Volvo	x	x	51
Mitsubishi	x		52
Brockway	x		80
Diamond Reo/Reo	x		81
Freightliner/White	x		82
FWD	x		83
International Harvester/ Navistar Kenworth	x	x	84
Mack	x		86
Peterbilt	x		87
Iveco/Magirus	x		88
Other Make			98

Classification for Medium/Heavy Trucks and Buses (continued)

For Make=98 (Other Medium/Heavy Trucks/ Buses, and Other Vehicle Makes), the following Model codes represent other truck and bus makes or types:

Other Truck and Bus Makes:

Autocar	801
Auto-Union-DKW	802
Divco	803
Western Star	804
Oshkosh	805
Hino	806
Scania	807
Sterling Trucks	808
Neoplan (bus)	902

Codes for medium and heavy truck models and bus models are shown below. These codes are used for all manufacturers of medium/heavy trucks and buses:

Truck and Bus Models:

Light truck based motorhome	498
Unknown type light motorhome	499
Truck based motorhome	850
Medium/Heavy CBE	881
Medium/Heavy COE-low entry	882
Medium/Heavy COE-high entry	883
Medium/Heavy Unknown engine location	884
Medium/Heavy COE-entry position unknown	890
Medium/Heavy - Other	898
Unknown light/medium/heavy truck	899
Bus based motorhome	950
Bus-conventional front engine	981
Bus - front engine/flat front	982
Bus - rear engine/flat front	983
Other Bus (e.g. Blue Bird, Chance Coach)	988
Unknown Bus	989
Other vehicle (e.g. farm vehicle, go-cart)	998
Unknown Vehicle	999

Appendix B:
V23 Accident Type Diagram

Category	Configuration	CRASH TYPES (includes intent)					
I Single Driver	A Right Roadside Departure	01 DRIVE OFF ROAD	02 CONTROL/ TRACTION LOSS	03 AVOID COLLISION WITH VEH., PED., ANIM.	04 SPECIFICS OTHER	05 SPECIFICS UNKNOWN	
	B Left Roadside Departure	06 DRIVE OFF ROAD	07 CONTROL/ TRACTION LOSS	08 AVOID COLLISION WITH VEH., PED., ANIM.	09 SPECIFICS OTHER	10 SPECIFICS UNKNOWN	
	C Forward Impact	11 PARKED VEH	12 STA OBJECT	13 PEDESTRIAN/ ANIMAL	14 END DEPARTURE	15 SPECIFICS OTHER	16 SPECIFICS UNKNOWN
II Same Trafficway Same Direction	D Rear End	20, 21, 22, 23 STOPPED	24, 25, 26, 27 SLOWER	28, 29, 30, 31 DECEL.	(EACH - 32) SPECIFICS OTHER	(EACH - 33) SPECIFICS UNKNOWN	
	E Forward Impact	34, 35 CONTROL/ TRACTION LOSS	36, 37 CONTROL/ TRACTION LOSS	38, 39 AVOID COLLISION WITH VEH.	40, 41 AVOID COLLISION WITH OBJECT	(EACH - 42) SPECIFICS OTHER	(EACH - 43) SPECIFICS UNKNOWN
	F Angle, Sideswipe	44, 45	46, 47	(EACH - 48) SPECIFICS OTHER	(EACH - 49) SPECIFICS UNKNOWN		
III Same Trafficway Opposite Direction	G Head-On	50, 51	(EACH - 52) SPECIFICS OTHER	(EACH - 53) SPECIFICS UNKNOWN			
	H Forward Impact	54, 55 CONTROL/ TRACTION LOSS	56, 57 CONTROL/ TRACTION LOSS	58, 59 AVOID COLLISION WITH VEH.	60, 61 AVOID COLLISION WITH OBJECT	(EACH - 62) SPECIFICS OTHER	(EACH - 63) SPECIFICS UNKNOWN
	I Angle, Sideswipe	64, 65 Lateral Moves	(EACH - 66) SPECIFICS OTHER	(EACH - 67) SPECIFICS UNKNOWN			
IV Change Trafficway Vehicle Turning	J Turn Across Path	68, 69 Initial Opposite Directions	70, 71, 72, 73 Initial Same Directions	(EACH - 74) SPECIFICS OTHER	(EACH - 75) SPECIFICS UNKNOWN		
	K Turn Into Path	76, 77, 78, 79 Turn Into Same Direction	80, 81, 82, 83 Turn Into Opposite Direction	(EACH - 84) SPECIFICS OTHER	(EACH - 85) SPECIFICS UNKNOWN		
V Intersect Paths	L Straight Paths	86, 87 Striking from the Right	88, 89 Striking from the Left	(EACH - 90) SPECIFICS OTHER	(EACH - 91) SPECIFICS UNKNOWN		
VI Misc.	M Backing, Etc.	92 Backing Veh.	93 Other Veh. or Object	98 Other Accident Type	99 Unknown Accident Type	00 No Impact	

**Appendix C:
Additional Variable Information**

Date of Crash

NHTSA'S Time of Day / Day of Week Convention	
Classification	Data Year and Code
Time of Day	1975-later HOUR (Military)
Daytime (6 a.m. – 5:59 p.m.)	6-17
Nighttime (6 p.m. – 5:59 a.m.)	0-5, 18-24
Unknown	99
Day of Week	DAY_WEEK w/ HOUR
Weekday 6 a.m. Monday thru 5:59 p.m. Friday	(DAY_WEEK=2 and 6<=HOUR<=23) or (DAY_WEEK in (3,4,5)) or (DAY_WEEK =6 and (0<= HOUR <=17 or HOUR 24))
Weekend 6 p.m. Friday thru 5:59 a.m. Monday	(DAY_WEEK =6 and 18<= HOUR <=23) or (DAY_WEEK in (1,7)) or (DAY_WEEK =2 and (0<= HOUR <=5 or HOUR 24))
Unknown	(DAY_WEEK =9) or (DAY_WEEK in (2,6) and HOUR =99)

Holidays - Note: The length of a "FARS holiday" depends on the day on which the holiday occurs. NHTSA uses the following times for holiday analysis:

DAY OF HOLIDAY	TIME PERIOD USED FOR ANALYSIS
Sunday or Monday	6 p.m. Friday to 5:59 a.m. Tuesday
Tuesday	6 p.m. Friday to 5:59 a.m. Wednesday
Wednesday	6 p.m. Tuesday to 5:59 a.m. Thursday
Thursday	6 p.m. Wednesday to 5:59 a.m. Monday
Friday or Saturday	6 p.m. Thursday to 5:59 a.m. Monday

HOLIDAY DESCRIPTIONS AND CALENDARS

The following table gives a detailed description of the time periods included within the following major holidays: New Year's, Memorial Day, Fourth of July, Labor Day, Thanksgiving and Christmas. The number of whole days in the holiday period is shown in parentheses. Since the holiday period data retrieval is associated with the alcohol related data, the holiday periods are given from 1982 onwards to match with the BAC data. Calendars from 1982 through 2010 follow this table.

* When using the Alcohol files, the New Year's Day holiday period for 1982 will be incomplete since no Alcohol files exist prior to 1982.

Date of Crash (continued)

HOLIDAY CALENDAR

Year	New Year's Day	Memorial Day	Fourth of July	Labor Day	Thanksgiving Day	Christmas Day
1982*	6:00 PM Thu. 12/31/1981 to 5:59 AM Mon. 01/04/1982 (3)	6:00 PM Fri. 05/28/1982 to 5:59 AM Tue. 06/01/1982 (3)	6:00 PM Fri. 07/02/1982 to 5:59 AM Tue. 07/06/1982 (3)	6:00 PM Fri. 09/03/1982 to 5:59 AM Tue. 09/07/1982 (3)	6:00 PM Wed. 11/24/1982 to 5:59 AM Mon. 11/29/1982 (4)	6:00 PM Thu. 12/23/1982 to 5:59 AM Mon. 12/27/1982 (3)
1983	6:00 PM Thu. 12/30/1982 to 5:59 AM Mon. 01/03/1983 (3)	6:00 PM Fri. 05/27/1983 to 5:59 AM Tue. 05/31/1983 (3)	6:00 PM Fri. 07/01/1983 to 5:59 AM Tue. 07/05/1983 (3)	6:00 PM Fri. 09/02/1983 to 5:59 AM Tue. 09/06/1983 (3)	6:00 PM Wed. 11/23/1983 to 5:59 AM Mon. 11/28/1983 (4)	6:00 PM Fri. 12/23/1983 to 5:59 AM Tue. 12/27/1983 (3)
1984	6:00 PM Fri. 12/30/1983 to 5:59 AM Tue. 01/03/1984 (3)	6:00 PM Fri. 05/25/1984 to 5:59 AM Tue. 05/29/1984 (3)	6:00 PM Tue. 07/03/1984 to 5:59 AM Thu. 07/05/1984 (1)	6:00 PM Fri. 08/31/1984 to 5:59 AM Tue. 09/04/1984 (3)	6:00 PM Wed. 11/21/1984 to 5:59 AM Mon. 11/26/1984 (4)	6:00 PM Fri. 12/21/1984 to 5:59 AM Wed. 12/26/1984 (4)
1985	6:00 PM Fri. 12/28/1984 to 5:59 AM Wed. 01/02/1985 (4)	6:00 PM Fri. 05/24/1985 to 5:59 AM Tue. 05/28/1985 (3)	6:00 PM Wed. 07/03/1985 to 5:59 AM Mon. 07/08/1985 (4)	6:00 PM Fri. 08/30/1985 to 5:59 AM Tue. 09/03/1985 (3)	6:00 PM Wed. 11/27/1985 to 5:59 AM Mon. 12/02/1985 (4)	6:00 PM Tue. 12/24/1985 to 5:59 AM Thu. 12/26/1985 (1)
1986	6:00 PM Tue. 12/31/1985 to 5:59 AM Thu. 01/02/1986 (1)	6:00 PM Fri. 05/23/1986 to 5:59 AM Tue. 05/27/1986 (3)	6:00 PM Thu. 07/03/1986 to 5:59 AM Mon. 07/07/1986 (3)	6:00 PM Fri. 08/29/1986 to 5:59 AM Tue. 09/02/1986 (3)	6:00 PM Wed. 11/26/1986 to 5:59 AM Mon. 12/01/1986 (4)	6:00 PM Wed. 12/24/1986 to 5:59 AM Mon. 12/29/1986 (4)
1987	6:00 PM Wed. 12/31/1986 to 5:59 AM Mon. 01/05/1987 (4)	6:00 PM Fri. 05/22/1987 to 5:59 AM Tue. 05/26/1987 (3)	6:00 PM Thu. 07/02/1987 to 5:59 AM Mon. 07/06/1987 (3)	6:00 PM Fri. 09/04/1987 to 5:59 AM Tue. 09/08/1987 (3)	6:00 PM Wed. 11/25/1987 to 5:59 AM Mon. 11/30/1987 (4)	6:00 PM Thu. 12/24/1987 to 5:59 AM Mon. 12/28/1987 (3)
1988	6:00 PM Thu. 12/31/1987 to 5:59 AM Mon. 01/04/1988 (3)	6:00 PM Fri. 05/27/1988 to 5:59 AM Tue. 05/31/1988 (3)	6:00 PM Fri. 07/01/1988 to 5:59 AM Tue. 07/05/1988 (3)	6:00 PM Fri. 09/02/1988 to 5:59 AM Tue. 09/06/1988 (3)	6:00 PM Wed. 11/23/1988 to 5:59 AM Mon. 11/28/1988 (4)	6:00 PM Fri. 12/23/1988 to 5:59 AM Tue. 12/27/1988 (3)
1989	6:00 PM Fri. 12/30/1988 to 5:59 AM Tue. 01/03/1989 (3)	6:00 PM Fri. 05/26/1989 to 5:59 AM Tue. 05/30/1989 (3)	6:00 PM Fri. 06/30/1989 to 5:59 AM Wed. 07/05/1989 (4)	6:00 PM Fri. 09/01/1989 to 5:59 AM Tue. 09/05/1989 (3)	6:00 PM Wed. 11/22/1989 to 5:59 AM Mon. 11/27/1989 (4)	6:00 PM Fri. 12/22/1989 to 5:59 AM Tue. 12/26/1989 (3)
1990	6:00 PM Fri. 12/29/1989 to 5:59 AM Tue. 01/02/1990 (3)	6:00 PM Fri. 05/25/1990 to 5:59 AM Tue. 05/29/1990 (3)	6:00 PM Tue. 07/03/1990 to 5:59 AM Thu. 07/05/1990 (1)	6:00 PM Fri. 08/31/1990 to 5:59 AM Tue. 09/04/1990 (3)	6:00 PM Wed. 11/21/1990 to 5:59 AM Mon. 11/26/1990 (4)	6:00 PM Fri. 12/21/1990 to 5:59 AM Wed. 12/26/1990 (4)
1991	6:00 PM Fri. 12/28/1990 to 5:59 AM Wed. 01/02/1991 (4)	6:00 PM Fri. 05/24/1991 to 5:59 AM Tue. 05/28/1991 (3)	6:00 PM Wed. 07/03/1991 to 5:59 AM Mon. 07/08/1991 (4)	6:00 PM Fri. 08/30/1991 to 5:59 AM Tue. 09/03/1991 (3)	6:00 PM Wed. 11/27/1991 to 5:59 AM Mon. 12/02/1991 (4)	6:00 PM Tue. 12/24/1991 to 5:59 AM Thu. 12/26/1991 (1)
1992	6:00 PM Tue. 12/31/1991 to 5:59 AM Thu. 01/02/1992 (1)	6:00 PM Fri. 05/22/1992 to 5:59 AM Tue. 05/26/1992 (3)	6:00 PM Thu. 07/02/1992 to 5:59 AM Mon. 07/06/1992 (3)	6:00 PM Fri. 09/04/1992 to 5:59 AM Tue. 09/08/1992 (3)	6:00 PM Wed. 11/25/1992 to 5:59 AM Mon. 11/30/1992 (4)	6:00 PM Thu. 12/24/1992 to 5:59 AM Mon. 12/28/1992 (3)

Date of Crash (continued)

HOLIDAY CALENDAR

Year	New Year's Day	Memorial Day	Fourth of July	Labor Day	Thanksgiving Day	Christmas Day
1993	6:00 PM Thu. 12/31/1992 to 5:59 AM Mon. 01/04/1993 (3)	6:00 PM Fri. 05/28/1993 to 5:59 AM Tue. 06/01/1993 (3)	6:00 PM Fri. 07/02/1993 to 5:59 AM Tue. 07/06/1993 (3)	6:00 PM Fri. 09/03/1993 to 5:59 AM Tue. 09/07/1993 (3)	6:00 PM Wed. 11/24/1993 to 5:59 AM Mon. 11/29/1993 (4)	6:00 PM Thu. 12/23/1993 to 5:59 AM Mon. 12/27/1993 (3)
1994	6:00 PM Thu. 12/30/1993 to 5:59 AM Mon. 01/03/1994 (3)	6:00 PM Fri. 05/27/1994 to 5:59 AM Tue. 05/31/1994 (3)	6:00 PM Fri. 07/01/1994 to 5:59 AM Tue. 07/05/1994 (3)	6:00 PM Fri. 09/02/1994 to 5:59 AM Tue. 09/06/1994 (3)	6:00 PM Wed. 11/23/1994 to 5:59 AM Mon. 11/28/1994 (4)	6:00 PM Fri. 12/23/1994 to 5:59 AM Tue. 12/27/1994 (3)
1995	6:00 PM Fri. 12/30/1994 to 5:59 AM Tue. 01/03/1995 (3)	6:00 PM Fri. 05/26/1995 to 5:59 AM Tue. 05/30/1995 (3)	6:00 PM Fri. 06/30/1995 to 5:59 AM Wed. 07/05/1995 (4)	6:00 PM Fri. 09/01/1995 to 5:59 AM Tue. 09/05/1995 (3)	6:00 PM Wed. 11/22/1995 to 5:59 AM Mon. 11/27/1995 (4)	6:00 PM Fri. 12/22/1995 to 5:59 AM Tue. 12/26/1995 (3)
1996	6:00 PM Fri. 12/29/1995 to 5:59 AM Tue. 01/02/1996 (3)	6:00 PM Fri. 05/24/1996 to 5:59 AM Tue. 05/28/1996 (3)	6:00 PM Wed. 07/03/1996 to 5:59 AM Mon. 07/08/1996 (4)	6:00 PM Fri. 08/30/1996 to 5:59 AM Tue. 09/03/1996 (3)	6:00 PM Wed. 11/27/1996 to 5:59 AM Mon. 12/02/1996 (4)	6:00 PM Tue. 12/24/1996 to 5:59 AM Thu. 12/26/1996 (1)
1997	6:00 PM Tue. 12/31/1996 to 5:59 AM Thu. 01/02/1997 (1)	6:00 PM Fri. 05/23/1997 to 5:59 AM Tue. 05/27/1997 (3)	6:00 PM Thu. 07/03/1997 to 5:59 AM Mon. 07/07/1997 (3)	6:00 PM Fri. 08/29/1997 to 5:59 AM Tue. 09/02/1997 (3)	6:00 PM Wed. 11/26/1997 to 5:59 AM Mon. 12/01/1997 (4)	6:00 PM Wed. 12/24/1997 to 5:59 AM Mon. 12/29/1997 (4)
1998	6:00 PM Wed. 12/31/1997 to 5:59 AM Mon. 01/05/1998 (4)	6:00 PM Fri. 05/22/1998 to 5:59 AM Tue. 05/26/1998 (3)	6:00 PM Thu. 07/02/1998 to 5:59 AM Mon. 07/06/1998 (3)	6:00 PM Fri. 09/04/1998 to 5:59 AM Tue. 09/08/1998 (3)	6:00 PM Wed. 11/25/1998 to 5:59 AM Mon. 11/30/1998 (4)	6:00 PM Thu. 12/24/1998 to 5:59 AM Mon. 12/28/1998 (3)
1999	6:00 PM Thu. 12/31/1998 to 5:59 AM Mon. 01/04/1999 (3)	6:00 PM Fri. 05/28/1999 to 5:59 AM Tue. 06/01/1999 (3)	6:00 PM Fri. 07/02/1999 to 5:59 AM Tue. 07/06/1999 (3)	6:00 PM Fri. 09/03/1999 to 5:59 AM Tue. 09/07/1999 (3)	6:00 PM Wed. 11/24/1999 to 5:59 AM Mon. 11/29/1999 (4)	6:00 PM Thu. 12/23/1999 to 5:59 AM Mon. 12/27/1999 (3)
2000	6:00 PM Thu. 12/30/1999 to 5:59 AM Mon. 01/03/2000 (3)	6:00 PM Fri. 05/26/2000 to 5:59 AM Tue. 05/30/2000 (3)	6:00 PM Fri. 06/30/2000 to 5:59 AM Wed. 07/05/2000 (4)	6:00 PM Fri. 09/01/2000 to 5:59 AM Tue. 09/05/2000 (3)	6:00 PM Wed. 11/22/2000 to 5:59 AM Mon. 11/27/2000 (4)	6:00 PM Fri. 12/22/2000 to 5:59 AM Tue. 12/26/2000 (3)
2001	6:00 PM Fri. 12/29/2000 to 5:59 AM Tue. 01/02/2001 (3)	6:00 PM Fri. 05/25/2001 to 5:59 AM Tue. 05/29/2001 (3)	6:00 PM Tue. 07/03/2001 to 5:59 AM Thu. 07/05/2001 (1)	6:00 PM Fri. 08/31/2001 to 5:59 AM Tue. 09/04/2001 (3)	6:00 PM Wed. 11/21/2001 to 5:59 AM Mon. 11/26/2001 (4)	6:00 PM Fri. 12/21/2001 to 5:59 AM Wed. 12/26/2001 (4)
2002	6:00 PM Fri. 12/28/2001 to 5:59 AM Wed. 01/02/2002 (4)	6:00 PM Fri. 05/24/2002 to 5:59 AM Tue. 05/28/2002 (3)	6:00 PM Wed. 07/03/2002 to 5:59 AM Mon. 07/08/2002 (4)	6:00 PM Fri. 08/30/2002 to 5:59 AM Tue. 09/03/2002 (3)	6:00 PM Wed. 11/27/2002 to 5:59 AM Mon. 12/02/2002 (4)	6:00 PM Tue. 12/24/2002 to 5:59 AM Thu. 12/26/2002 (1)
2003	6:00 PM Tue. 12/31/2002 to 5:59 AM Thu. 01/02/2003 (1)	6:00 PM Fri. 05/23/2003 to 5:59 AM Tue. 05/27/2003 (3)	6:00 PM Thu. 07/03/2003 to 5:59 AM Mon. 07/07/2003 (3)	6:00 PM Fri. 08/29/2003 to 5:59 AM Tue. 09/02/2003 (3)	6:00 PM Wed. 11/26/2003 to 5:59 AM Mon. 12/01/2003 (4)	6:00 PM Wed. 12/24/2003 to 5:59 AM Mon. 12/29/2003 (4)

Date of Crash (continued)

HOLIDAY CALENDAR

Year	New Year's Day	Memorial Day	Fourth of July	Labor Day	Thanksgiving Day	Christmas Day
2004	6:00 PM Wed. 12/31/2003 to 5:59 AM Mon. 01/05/2004 (4)	6:00 PM Fri. 05/28/2004 to 5:59 AM Tue. 06/01/2004 (3)	6:00 PM Fri. 07/02/2004 to 5:59 AM Tue. 07/06/2004 (3)	6:00 PM Fri. 09/03/2004 to 5:59 AM Tue. 09/07/2004 (3)	6:00 PM Wed. 11/24/2004 to 5:59 AM Mon. 11/29/2004 (4)	6:00 PM Thu. 12/23/2004 to 5:59 AM Mon. 12/27/2004 (3)
2005	6:00 PM Thu. 12/30/2004 to 5:59 AM Mon. 01/03/2005 (3)	6:00 PM Fri. 05/27/2005 to 5:59 AM Tue. 05/31/2005 (3)	6:00 PM Fri. 07/01/2005 to 5:59 AM Tue. 07/05/2005 (3)	6:00 PM Fri. 09/02/2005 to 5:59 AM Tue. 09/06/2005 (3)	6:00 PM Wed. 11/23/2005 to 5:59 AM Mon. 11/28/2005 (4)	6:00 PM Fri. 12/23/2005 to 5:59 AM Tue. 12/27/2005 (3)
2006	6:00 PM Fri. 12/30/2005 to 5:59 AM Tue. 01/03/2006 (3)	6:00 PM Fri. 05/26/2006 to 5:59 AM Tue. 05/30/2006 (3)	6:00 PM Fri. 06/30/2006 to 5:59 AM Wed. 07/05/2006 (4)	6:00 PM Fri. 09/01/2006 to 5:59 AM Tue. 09/05/2006 (3)	6:00 PM Wed. 11/22/2006 to 5:59 AM Mon. 11/27/2006 (4)	6:00 PM Fri. 12/22/2006 to 5:59 AM Tue. 12/26/2006 (3)
2007	6:00 PM Fri. 12/29/2006 to 5:59 AM Tue. 01/02/2007 (3)	6:00 PM Fri. 05/25/2007 to 5:59 AM Tue. 05/29/2007 (3)	6:00 PM Tue. 07/03/2007 to 5:59 AM Thu. 07/05/2007 (1)	6:00 PM Fri. 08/31/2007 to 5:59 AM Tue. 09/04/2007 (3)	6:00 PM Wed. 11/21/2007 to 5:59 AM Mon. 11/26/2007 (4)	6:00 PM Fri. 12/21/2007 to 5:59 AM Wed. 12/26/2007 (4)
2008	6:00 PM Fri. 12/28/2007 to 5:59 AM Wed. 01/02/2008 (4)	6:00 PM Fri. 05/23/2008 to 5:59 AM Tue. 05/27/2008 (3)	6:00 PM Thu. 07/03/2008 to 5:59 AM Mon. 07/07/2008 (3)	6:00 PM Fri. 08/29/2008 to 5:59 AM Tue. 09/02/2008 (3)	6:00 PM Wed. 11/26/2008 to 5:59 AM Mon. 12/01/2008 (4)	6:00 PM Wed. 12/24/2008 to 5:59 AM Mon. 12/29/2008 (4)
2009	6:00 PM Wed. 12/31/2008 to 5:59 AM Mon. 01/05/2009 (4)	6:00 PM Fri. 05/22/2009 to 5:59 AM Tue. 05/26/2009 (3)	6:00 PM Thu. 07/02/2009 to 5:59 AM Mon. 07/06/2009 (3)	6:00 PM Fri. 09/04/2009 to 5:59 AM Tue. 09/08/2009 (3)	6:00 PM Wed. 11/25/2009 to 5:59 AM Mon. 11/30/2009 (4)	6:00 PM Thu. 12/24/2009 to 5:59 AM Mon. 12/28/2009 (3)
2010	6:00 PM Thu. 12/31/2009 to 5:59 AM Mon. 01/04/2010 (3)	6:00 PM Fri. 05/28/2010 to 5:59 AM Tue. 06/01/2010 (3)	6:00 PM Fri. 07/02/2010 to 5:59 AM Tue. 07/06/2010 (3)	6:00 PM Fri. 09/03/2010 to 5:59 AM Tue. 09/07/2010 (3)	6:00 PM Wed. 11/24/2010 to 5:59 AM Mon. 11/29/2010 (4)	6:00 PM Thu. 12/23/2010 to 5:59 AM Mon. 12/27/2010 (3)
2011	6:00 PM Thu. 12/30/2010 to 5:59 AM Mon. 01/03/2011 (3)	6:00 PM Fri. 05/27/2011 to 5:59 AM Tue. 05/31/2011 (3)	6:00 PM Fri. 07/01/2011 to 5:59 AM Tue. 07/05/2011 (3)	6:00 PM Fri. 09/02/2011 to 5:59 AM Tue. 09/06/2011 (3)	6:00 PM Wed. 11/23/2011 to 5:59 AM Mon. 11/28/2011 (4)	6:00 PM Fri. 12/23/2011 to 5:59 AM Tue. 12/27/2011 (3)
2012	6:00 PM Fri. 12/30/2011 to 5:59 AM Tue. 01/03/2012 (3)	6:00 PM Fri. 05/25/2012 to 5:59 AM Tue. 05/29/2012 (3)	6:00 PM Tue. 07/03/2012 to 5:59 AM Thu. 07/05/2012 (1)	6:00 PM Fri. 08/31/2012 to 5:59 AM Tue. 09/04/2012 (3)	6:00 PM Wed. 11/21/2012 to 5:59 AM Mon. 11/26/2012 (4)	6:00 PM Fri. 12/21/2012 to 5:59 AM Wed. 12/26/2012 (4)
2013	6:00 PM Fri. 12/28/2012 to 5:59 AM Wed. 01/02/2013 (4)	6:00 PM Fri. 05/24/2013 to 5:59 AM Tue. 05/28/2013 (3)	6:00 PM Wed. 07/03/2013 to 5:59 AM Mon. 07/08/2013 (4)	6:00 PM Fri. 08/30/2013 to 5:59 AM Tue. 09/03/2013 (3)	6:00 PM Wed. 11/27/2013 to 5:59 AM Mon. 12/02/2013 (4)	6:00 PM Tue. 12/24/2013 to 5:59 AM Thu. 12/26/2013 (1)
2014	6:00 PM Tue. 12/31/2013 to 5:59 AM Thu. 01/02/2014 (1)	6:00 PM Fri. 05/23/2014 to 5:59 AM Tue. 05/27/2014 (3)	6:00 PM Thu. 07/03/2014 to 5:59 AM Mon. 07/07/2014 (3)	6:00 PM Fri. 08/29/2014 to 5:59 AM Tue. 09/02/2014 (3)	6:00 PM Wed. 11/26/2014 to 5:59 AM Mon. 12/01/2014 (4)	6:00 PM Wed. 12/24/2014 to 5:59 AM Mon. 12/29/2014 (4)

Note: The number of whole days in the holiday period is shown in parenthesis.

[Return](#)

Manner of Collision

Note: From 1975 to 2001, the manner of collision is totally dependent on the directions of travel of the vehicles involved. The direction of travel of the vehicles is often misunderstood. The direction of a vehicle is determined by the pre-crash condition direction of travel, just before the vehicle goes out of control. Example (1): Assume two vehicles are heading toward each other on the same roadway, one going north and the other going south. If the southbound vehicle skids on a patch of ice and turns 180O and immediately is struck in the rear by the vehicle going north, then the manner of collision is “Head-On,” not “Rear-End.” Example (2): Had the vehicle going north sideswiped the southbound vehicle, which after the ice skid was pointed north, the manner of collision would be “Sideswipe Opposite Direction,” even though both vehicles are pointed north at the time of the sideswipe. The pre-crash condition directions of travel, for both vehicles, determine the outcome. These examples involve a rotation of a vehicle just before the crash and can account for 20 to 30 percent of the coded cases. See "Impact" in the vehicle section of this guide.

Starting in 2002 and later, the manner of collision is dependent on the geometry of the points of impact. That is, Example (1) above is now coded 01, Front-to-Rear (includes Rear-End) and Example (2), is now coded 07 Sideswipe, Same Direction. This is a major change in the MAN_COLL variable. Care must be taken when using this variable over a time period that spans 2001 to 2002.

NHTSA’S Manner Of Collision Convention			
Classification (MAN_COLL)	Data Year and Code		
	1975-1977	1978-2001	2002 and later
Not Collision with Motor Vehicle in Transport	0	0	00
Rear-End	1	1	01
Head-On	2	2	02
Angle	4	4	03-06
Sideswipe	7	5, 6	07-08
Other	3	3	09-11
Unknown	9	9	99, *98 (2010)

Since 2002, this element has been based on the impact location (front, side, or rear) and vehicle orientation (facing in the same or opposite directions) of the contact vehicles in the First Harmful Event. The use of “direction of force” will no longer be used in determining this element. Prior to 2002, the “direction of force” immediately preceding the collision was allowed to be considered, especially in head-on collisions.

Notes: Refers only to crashes in which the FIRST HARMFUL EVENT is a collision between two motor vehicles in transport (codes 12 and 13).

Manner of Collision (continued)

Use the Diagrams below to help determine Manner of Collision codes 01-05, 07-08

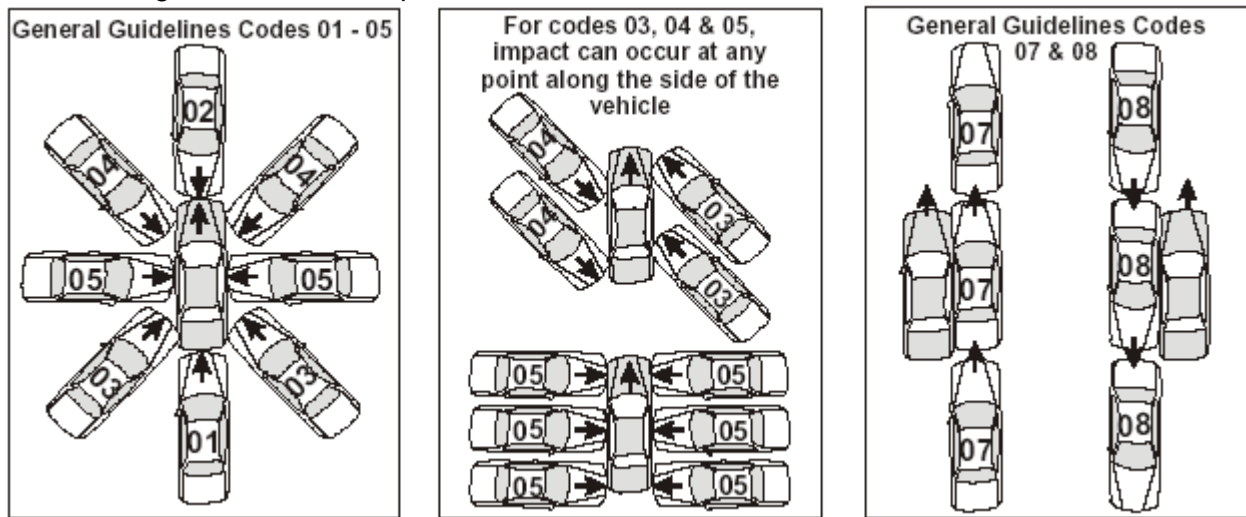

Comparison of Grouped Attributes

1975-1977	1978-2001	2002-Later	
0	0	00	Not Collision with Motor Vehicle in Transport
1	1	01	Rear-End
2	2	02	Head-On
4	4	03-06	Angle
7	5, 6	07-08	Sideswipe
3	3	09-11	Other
9	9	99	Unknown

[Return](#)

Related Factors- Crash Level

Notes: There are also vehicle-level-related factors in the Vehicle file, VEH_CF1 and VEH_CF2 and driver-related factors, also in the Vehicle file, namely DR_CF1, DR_CF2, DR_CF3 and (DR_CF4 since 1997). In addition there are person-related-factors P_CF1, P_CF2, and P_CF3 in the person file.

The FARS analyst may have used any of the three variables to code a related factor. One must test all three variables to insure that the selected related factor is included.

Note: Starting in 1982, many of the Related Factors Crash Level factors, values 01 - 29, are coded as Related Factors - Driver Level, values 61 - 87, in the vehicle section of the data.

[Return](#)

Relation to Trafficway

Note: Two-way continuous left-turn lane was captured under Median prior to 2001.

Trafficway with frontage Road

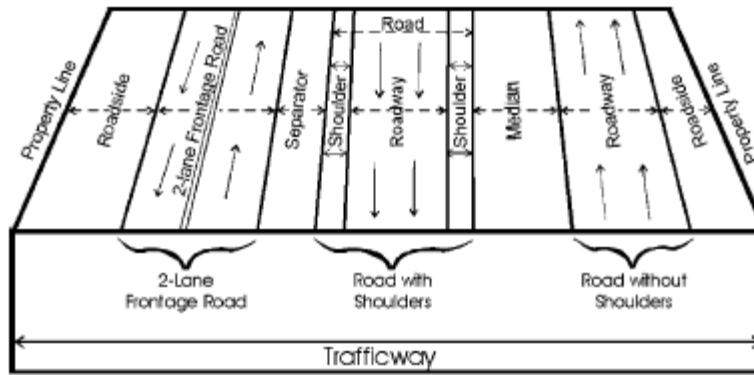

Trafficway with multiple roadways in the same direction

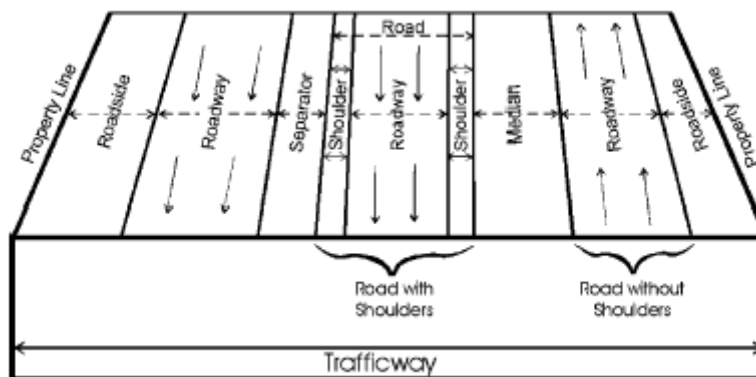

Relation to Trafficway (continued)

Gore

★ Radius of 60 Meters
(About 200 Feet)

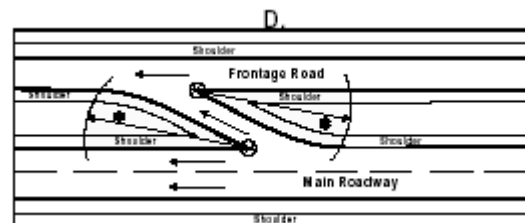
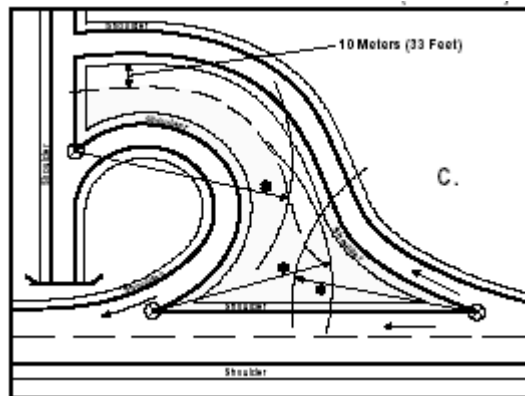
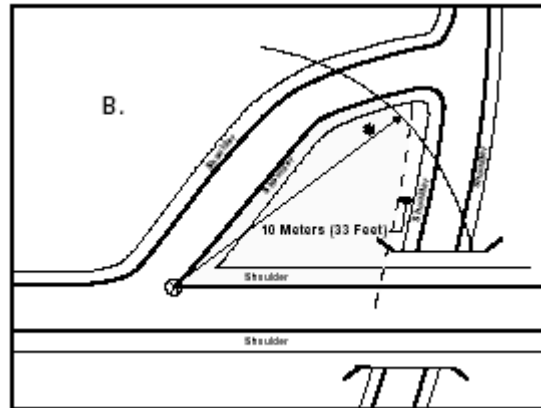
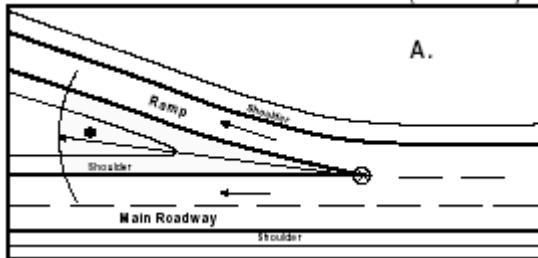

[Return](#)

Roadway Function Class and Land Use

NHTSA'S Roadway Function Class Convention		
Classification (ROAD_FNC)	Data Year and Code	
	1981-1986	1987and later
Interstate, principal arterial	1	01, 11
Freeway and expressway, principal arterial	2	12
Principal arterial, other	3	02, 13
Minor arterial	4	03, 14
Collector	5, 6, 7	04, 05, 15
Local	8	06, 16
Unknown	9	09, 19, 99

NHTSA'S Land Use (Rural/Urban) Convention		
Classification	Data Year and Code	
	1981-1986 (LAND_USE)	1987and later (ROAD_FNC)
Rural	2	01-06, 09
Urban	1	11-16, 19
Unknown	9	99

NHTSA'S Interstate and Non-Interstate Convention			
Classification	Data Year and Code		
	1975-1980 (CL_TWAY)	1981-1986 (ROAD_FNC)	1987and later (ROAD_FNC)
Interstate	1	1	01, 11
Non-Interstate	2-8	2-8	02-06, 12-16
Unknown	9	9	09, 19, 99

[Return](#)

Trafficway Identifier

If ROUTE SIGNING is 1 (Interstate), then “I-” is in the first two spaces of TRAFFICWAY IDENTIFIER

If ROUTE SIGNING is 2 (US Highway), then “US-” is in the first three spaces of TRAFFICWAY IDENTIFIER

If ROUTE SIGNING is 3 (State Highway), then “SR-” is in the first three spaces of TRAFFICWAY IDENTIFIER

If Route Signing is other than “1, 2 or 3,” the route name or identifier is left-justified. (Example: County Route 10 would be just “10,” and “Front Street” would be “Front Street.”)

Immediately after the route designation (I-, US- or SR-), the corresponding highway number appears. For example, Interstate 70 should be coded as “I-70” and US 66 should be coded as “US-66.” A dash is used in the highway designation between the capital letters and the number.

If one trafficway is both a State Highway and an Interstate Highway, ROUTE SIGNING must always be coded “1-Interstate.”

(a) If the TRAFFICWAY IDENTIFIER and MILEPOINT are available for only the State Highway then the ROUTE SIGNING is coded as “1-Interstate.” “I-” is in the first two spaces of TRAFFICWAY IDENTIFIER followed by the full State Highway Identifier as normal (including any letters.) If California business loop (CA215) is also Interstate 15, then TRAFFICWAY IDENTIFIER is code as “I-SR215” or “I-CA215.”

(b) If the TRAFFICWAY IDENTIFIER and MILEPOINT are available for both the State Highway and the Interstate Highway, then “I-” appears in the first two spaces of TRAFFICWAY IDENTIFIER followed by the Interstate number. The Interstate MILEPOINT is coded. E.g., “I-15” (SR215) or “I-15” (CA215).

Similarly, if a State Highway is also a U.S. Highway, then the ROUTE SIGNING is coded as “2-US Highway.”

(a) If the TRAFFICWAY IDENTIFIER and MILEPOINT are available only for the State Highway, then the ROUTE SIGNING is coded as “2-US Highway.” “US-” appears in the first three spaces of TRAFFICWAY IDENTIFIER followed by the full State Highway Identifier as normal (including any letters). The State Highway MILEPOINT is coded. E.g.; If Florida Route 25 is also US Route 27, then code “US-SR25” or “US-FL25.”

(b) If the TRAFFICWAY IDENTIFIER and MILEPOINT are available for both the U.S. Highway and the State Highway, then “US-” is in the first three spaces of TRAFFICWAY IDENTIFIER followed by the U.S. route number. The State Highway Identifier appears anywhere after the US route number. The US Route MILEPOINT is coded. E.g. “US-27” (SR25) or “US-27” (FL25).

[Return](#)

Vehicle (Body Type) Classification

SAS Name: BODY_TYP by NHTSA vehicle category

NHTSA has precise definitions for several vehicle categories, such as passenger cars, pickups, buses, etc. For some categories, one will also need the variable TOW_VEH.

NHTSA's Vehicle Body Type Classification			
Classification (BODY_TYP)	Data Year and Code		
	1975-1981	1982-1990	1991-2010
Passenger Cars	01-09	01-11, 67	01-11, 17 (since 2010)
Light Trucks & Vans ⁽⁴⁾	43, 50-52, or (60 and tow_veh=0)	12, 40, 41, 48-51, 53-56, 58, 59, 68, 69, or (79 and tow_veh=0 or 9)	14-22, 24 ^(1,6) , 25 ^(2,6) , 28-41, 45-49, or (79 and tow_veh=0 or 9)
Large Trucks	53-59, or (60 and tow_veh=1)	70-72, 74-76, 78, or (79 and tow_veh in 1-5 ⁽⁸⁾)	60-64, 66, 67 ⁽⁵⁾ , 71, 72, 78, or (79 and tow_veh ⁽⁷⁾ in 1-4)
Motorcycles	15-18	20-29	80-89
Buses	25-29	30-39	50-59
Other/Unknown Vehicles	35-42, 44, 45, 99	13, 14, 42, 52, 73, 77, 80, 81, 82, 83, 88, 89, 90, 99	12, 13, 23 ⁽⁶⁾ , 42, 65, 73, 90, 91, 92, 93, 94 ⁽³⁾ , 97, 99 Also, since 2004 (79 and tow_veh ⁽⁷⁾ =5 or 6) or 98 (since 2010)
Passenger Vehicles	01-09, 43, 50-52, or (60 and tow_veh=0)	01-12, 40, 41, 48-51, 53-56, 58, 59, 67-69, or (79 and tow_veh=0 or 9)	01-11, 14-22, 24 ⁽¹⁾ , 25 ⁽²⁾ , 28-41, 45-49, or (79 and tow_veh=0 or 9) , or 17 (since 2010)
Utility Vehicles (a.k.a. On/Off Road)	43	12, 56, 68	14-16, 19
Pickups	50	50, 51	30-39
Vans	51	40, 41, 48, 49	20-22, 24 ^(1,6) , 25 ^(2,6) , 28, 29
Medium Trucks	53, 54, 56	70, 71, 75, 78	60-62, 64, 67 ⁽⁵⁾ , 71
Heavy Trucks	55, 57-59, or (60 and tow_veh=1)	72, 74, 76, or (79 and tow_veh in 1-5 ⁽⁸⁾)	63, 66, 72, 78, or (79 and tow_veh ⁽⁷⁾ in 1-4)
Combination Trucks	((53-56, 60) and tow_veh=1) or 57-59	((70-72, 75, 76, 78, 79) and tow_veh in 1-5 ⁽⁸⁾) or 74	((60-64, 71, 72, 78, 79) and tow_veh ⁽⁷⁾ in 1-4) or 66
Single Unit Trucks	(53-56, 60) and tow_veh =0	(70-72, 75, 76, 78, 79) and tow_veh in (0,9)	(60-62,63,64,67,71,72,78,79) and tow_veh in (0,5,6 ⁽⁷⁾ ,9)

⁽¹⁾ Body type code **24 (van-based school bus)** was added in 1993. When solely defining School Buses be sure to include body type code **24**.

⁽²⁾ Body type code **25 (van-based transit bus)** was added in 1993. When solely defining Transit Buses be sure to include body type code **25**.

⁽³⁾ Body type coded **94 (motorized wheelchair)** was added in **1997** and deleted in **1998**.

⁽⁴⁾ "Light Trucks & Vans" is frequently referred to as just "Light Trucks."

Vehicle (Body Type) Classification (continued)

⁽⁵⁾ Body type code **67** (*medium/heavy pickup (Ford Super Duty 450/550)*) was added in **2001**. For the purposes of medium and heavy truck classifications, this body type will be considered a medium truck.

⁽⁶⁾ Van-based bus (**24, 25**) and van-based motor home (**23**) body type codes were deleted in **2003**.

These attributes were removed because a review of the FARS Analyst coding revealed that they were rarely capturing them.

⁽⁷⁾ New code was added in 2004 for Vehicle Trailing (*tow_veh*) - **5 (vehicle towing another motor vehicle)**. In 2009 the attribute was split into two to distinguish between fixed and non-fixed linkages (5 and 6). This attribute is not a part of the selection criteria for Light, Large, Heavy, or Combination Truck classifications. Beginning with 2004, an *unknown truck type (light/medium/heavy)* that was *towing another vehicle* - (BODY_TYP=79 and TOW_VEH=5,6) - should be classified as *Other/Unknown*. **This classification is subject to change.**

⁽⁸⁾ From 1982 to 1990, *Vehicle Trailing (TOW_VEH)* attribute value 5 (yes, two or more trailing units) existed in 1982 only. Including "5" in the range from 1982 to 1990 does not affect the classification.

[Return](#)

Driver License Type Compliance

NHTSA'S Driver License Type Compliance			
Classification	Data Year and Code		
	1982-1986 (L_CL_VEH)	1987-1992 (L_COMPL)	1993 and later (L_COMPL)
Valid	0, 2, 4	1, 3	1, 3
Invalid	1, 3, 5	0, 2	0, 2
Unknown	9	9	8, 9

[Return](#)

Driver License Status/Type

NHTSA'S Driver License Status & Non-CDL Status				
Classification (L_STATUS)	Data Year and Code			
	1975-1981	1982-1986	1987-1992	1993 and later
Valid	0, 3, 7	0, 2, 7-8	5-6, 7-8	6-8
Invalid	1-2, 4-6	1, 3-6	0-4	0-4
Unknown	9	9	9	9

[Return](#)

Speeding

A fatal crash is “speeding” related if any of the following applies:

1. At least one driver involved in the crash had a speeding related *Driver Related Factor*. Note that in 2009 the *Driver Related Factor* attributes associated with speeding-related were deleted and a new data element, *Speed Related*, was introduced to capture this information.
2. At least one driver involved in the crash had a speeding related *Violation Charged*

Note: This definition was revised in 2002. The previous definition for “speeding” only looked at *Driver Related Factors*. By expanding the definition to include *Violations Charged*, “speeding” fatal crashes and fatalities increase by less than 1 percent.

FARS Description	Data Year and Codes					
	1982-1996	1997	1998-2007	2008	2009	2010
1. Driver Related Factor - DR_CF1, DR_CF2, DR_CF3, DR_CF4 (DR_CF4 was added in 1997, names were changed to be DR_SF1 – DR_SF4)						
Driving too fast for conditions or in excess of the posted maximum	44					-
Driving too fast for conditions	-			43		-
Driving in Excess of Posted Maximum	-			44		-
Racing	-		46			-
1 (new in 2009). Speed Related (SPEEDREL) – replaces speeding-related driver related factors.						
No	-					0
Yes (includes the following): • Speed greater than reasonable or prudent (not necessarily over the limit) • Driving too fast for conditions • Speeding (above the speed limit) • Exceeding special limit (e.g.: for trucks, buses, cycles, on bridge, at night, in school zone, etc.) • Racing	-					1
Unknown	-					9
2. Violations Charged	VIOL_CHG	VIOLCHG1, VIOLCHG2, VIOLCHG3			MVIOLATN	
Speeding	2	-				
Alcohol or drugs and speeding	3	-				
Racing	-				21	
Speeding (above the speed limit)	-				22	
Speed greater than reasonable and prudent (not necessarily over the limit)	-				23	
Exceeding special speed limit (e.g.: for trucks, buses, cycles, or on bridge, in school zone, etc.)	-				24	
Energy speed (exceeding 55 MPH, non-pointable)	-				25	
Speed related violations generally	-				29	

Speeding (continued)

Fatal speeding-related crashes are not captured prior to 1982 using this scheme because *violations charged* did not identify speeding violations prior to 1982.

[Return](#)

Impact

NHTSA'S Impact Initial Impact Point (IMPACT1) AND Principal Impact Point (IMPACT2)		
Classification	Data Year and Element	
	1975-1993 (IMPACT1) OR (IMPACT2)	1994 AND LATER (IMPACT1) OR (IMPACT2)
Non-Collision	00	00
Front	01, 11-12	01, 11-12
Right Side/Side	02-04	02-04
Left Side/Side	08-10	08-10
Rear	05-07	05-07
Other	13-16	13-14, 18 (added in 2004)
Unknown	99	99

CLOCKPOINT DIAGRAM

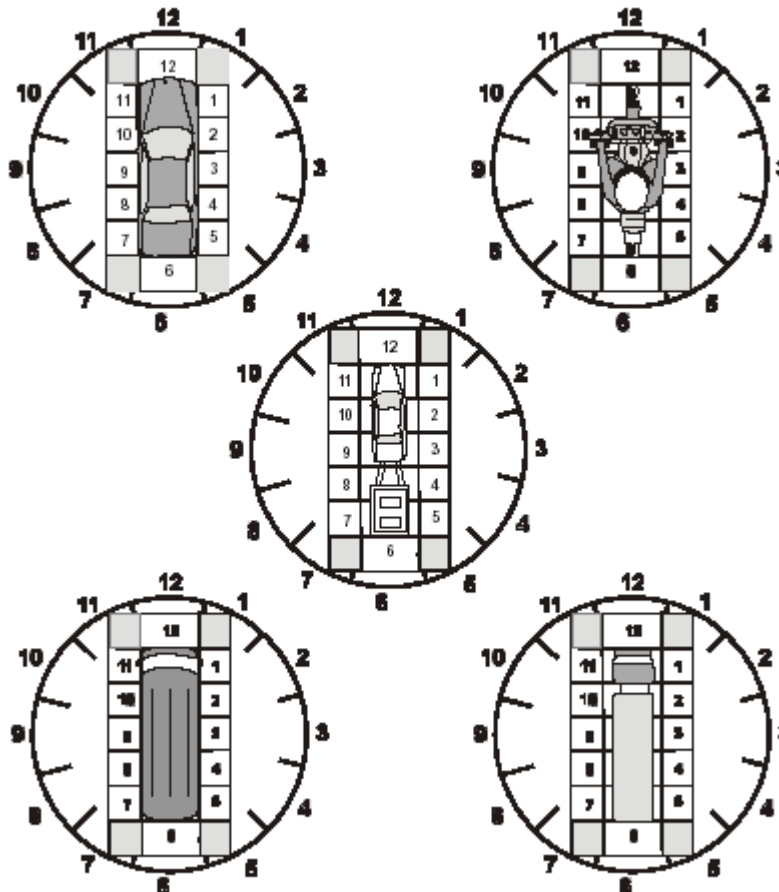

Impact (continued)

IMPACT POINTS

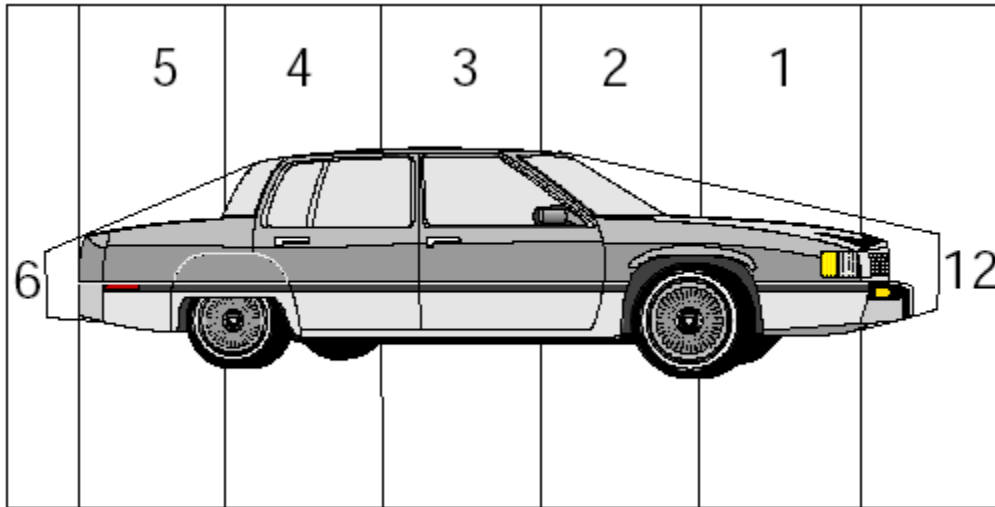

Right Side

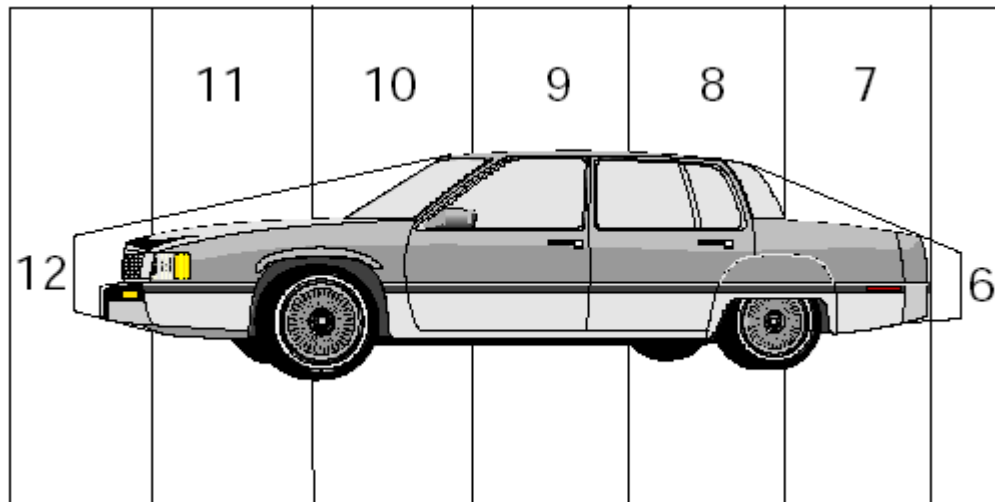

Left Side

Source: FARS Coding Manual

Impact (continued)

Element 13 Examples

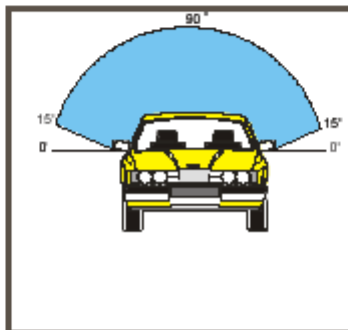
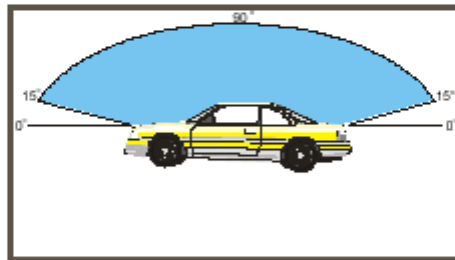
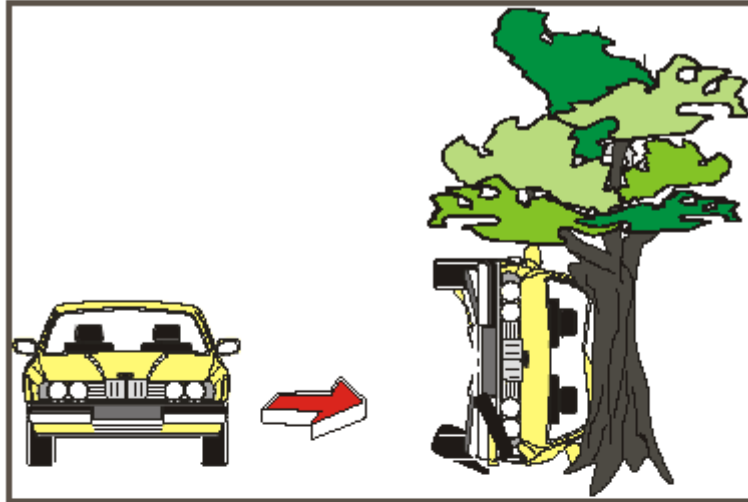

[Return](#)

VIN Weight- Auto

The Fatality Analysis Reporting System collects information on the weight of cars involved in fatal crashes. Vehicle weight is not generally available for light trucks, however, the weight element, WGTCD_TR, is. NHTSA often partitions car weight into six classes. This has been done in *An Analysis of Fires in Passenger Cars, Light Trucks, and Vans*, Tessmer, DOT HS 808 208, 1994; *Passenger Car Weight and Injury Severity in Single-Vehicle Nonrollover Crashes*, Partyka and Boehly, 1989; ESV Report 89-2b-O-005 and *Development of Databases in Support of an Analysis of Fire Incidence Using the Fatal Accident Reporting System*, Walz and Klein, September 14, 1993. The partition is defined as:

Car Weight Classes	
Class	Weight Range in Pounds
Class 1	Car Weight < 1,950
Class 2	$1,950 \leq \text{Car Weight} < 2,450$
Class 3	$2,450 \leq \text{Car Weight} < 2,950$
Class 4	$2,950 \leq \text{Car Weight} < 3,450$
Class 5	$3,450 \leq \text{Car Weight} < 3,950$
Class 6	$3,950 \leq \text{Car Weight}$

Note: If you are going to use this variable as a continuous variable, consider defining a new variable, say AUTO_WT as $\text{AUTO_WT} = \text{VIN_WT}/1000$. That is, AUTO_WT is the weight of the car in 1,000s of lbs. Its coefficient is less likely to be zero.

[Return](#)

Vehicle Identification Number (VIN)

Variables = VIN_1 ... VIN_12 The 1st to 12th character of the vehicle identification number

The first character of the VIN usually identifies the country or Nation of Origin; the most popular are:

VIN_1 =	1	U.S.
	2	Canada
	3	Mexico
	J	Japan
	K	Korea
	L	Taiwan
	S	England
	VF	France (V for Europe, F for France)
	W	West Germany
	Y	Sweden
	Z	Italy

1981-Later

The second and third characters of the VIN, more or less, identify the make of the vehicle; the most popular AUTOMOBILE makes are:

VIN_2|VIN_3 =

2A - AVANTI	E3 - EAGLE	G2 - PONTIAC
A3 - MITSUBISHI	F1 - EAGLE	G3 - OLDSMOBILE
AB - ISUZU	MEDALLION	G4 - BUICK
AJ - JAGUAR	(IF VIN_1 = V	G6 - CADILLAC
AM - MASERATI (IF	SEE	G8 - SATURN
VIN_1 = Z)	RENAULT)	H4 - ACURA
AM - AMERICAN	F1 - MERKUR (IF	HM - HONDA
MOTORS (IF	VIN_1 = W)	JC - JEEP
VIN_1 = 1)	F1 - RENAULT (IF	LN - LINCOLN
AR - ALPHA ROMEO	VIN_1 = V	M1 - MAZDA
AW - AUDI	SEE EAGLE	ME - MERCURY
AX - STERLING	MEDALLION)	MH - HYUNDAI
B3 - DODGE	F1 - SUBARU (IF	N1 - NISSAN
BA - BMW	VIN_1 = J)	P3 - PLYMOUTH
BB - BERTONE	F3 - PEUGEOT	PO - PORSCHE
C3 - CHRYSLER	FA - FORD (IF VIN_1	S3 - SAAB
CA - ROLLS ROYCE	= 1)	S3 - SUZUKI
CC - LOTUS	FA - FIAT (IF VIN_1 =	T2 - TOYOTA
CE - DELOREAN	Z)	V1 - VOLVO
CF - ASTON MARTIN	FF - FERRARI	VW - VOLKSWAGEN
DB - MERCEDES	FR - PININFARINA	
BENZ	G1 - CHEVROLET	

Vehicle Identification Number (VIN) (continued)**1981-Later**

The model year of the vehicle is usually the tenth character. The values are:

VIN_10 =

A - 1980

B - 1981

C - 1982

D - 1983

E - 1984

F - 1985

G - 1986

H - 1987

J - 1988

K - 1989

L - 1990

M - 1991

N - 1992

P - 1993

R - 1994

S - 1995

T - 1996

V - 1997

W - 1998

X - 1999

Y - 2000

1 - 2001

2 - 2002

3 - 2003

4 - 2004

5 - 2005

6 - 2006

7 - 2007

8 - 2008

9 - 2009

A - 2010

B - 2011

[Return](#)

Police Pursuits

A pursuit is an event that is initiated when a law enforcement officer, operating an authorized emergency vehicle, gives notice to stop (either through the use of visual or audible emergency signals or a combination of emergency devices) to a motorist who the officer is attempting to apprehend and that motorist fails to comply with the signal by either maintaining his/her speed, increasing speed or taking other evasive action to allude the officer’s continued attempts to stop the motorist.

Police Pursuits		
Classification	Data Year and Codes	
	1982-1993	1994-2010
Accident Related Factor - CF1, CF2, CF3		
Police pursuit involved	-	20
Driver Related Factor - DR_CF1, DR_CF2, DR_CF3, DR_CF4 (DR_CF4 was added in 1997)		
High speed chase with police in pursuit	37	

FARS 1982-1993

If at least one driver in a crash has a “*Driver Related Factor*” of *high speed chase with police in pursuit* (37) then that crash is considered a police pursuit crash and all fatalities in that crash are considered “fatalities in crashes involving police in pursuit.”

DR_CF1=37 or DR_CF2=37 or DR_CF3=37

Specific fatality types in a “police pursuit” crash can be identified as follows:

1. **occupant of police vehicle** - all occupants (*PER_TYP IN (1,2,9)*) of special use vehicle police (*SPEC_USE=5*)
2. **occupant of chased vehicle** - all occupants (*PER_TYP IN (1,2,9)*) of vehicle with a driver having a “driver related factor” of high speed chase with police in pursuit (*DR_CF1=37 OR DR_CF2=37 OR DR_CF3=37*)
3. **occupant of other vehicle** - all other occupants (*PER_TYP IN (1,2,9)*) - excludes occupant of police vehicle and chased vehicle
4. **nonoccupant** - pedestrians, pedalcyclists, and other nonoccupants (*PER_TYP IN (3,4,5,6,7,8)*)

Police Pursuits (continued)**FARS 1994 and later**

If a crash has an “Accident Related Factor” of police pursuit involved (20) or a driver in the crash has a “Driver Related Factor” of police pursuing this driver or police officer in pursuit (37) then that crash is considered a “police pursuit crash” and all fatalities in that crash are considered “fatalities in crashes involving police in pursuit.”

**CF1=20 or CF2=20 or CF3=20 or DR_CF1=37 or DR_CF2=37 or DR_CF3=37
(or DR_CF4=37 Since 1997)**

Specific fatality types can be identified as follows:

1. **occupant of police vehicle** - all occupants (*PER_TYP IN (1,2,9)*) of special use vehicle police (*SPEC_USE=5*)
2. **occupant of chased vehicle** - all occupants (*PER_TYP IN (1,2,9)*) of vehicle with a driver having a driver related factor of high speed chase with police in pursuit (*DR_CF1=37 OR DR_CF2=37 OR DR_CF3=37*). In 1997, DR_CF4 was added.
3. **occupant of other vehicle** - all other occupants (*PER_TYP IN (1,2,9)*) - excludes occupant of police vehicle and chased vehicle
4. **nonoccupant** - pedestrians, pedalcyclists, and other nonoccupants (*PER_TYP IN (3,4,5,6,7,8,19)*)
5. **unknown** - (*PER_TYP=99*), this code existed for one year – 1996

[Return](#)

Alcohol

References:

Subramanian, R. (2002) *Transitioning to Multiple Imputation: A New Method to Estimate Missing BAC in FARS*, Report DOT-HS-809-403, National Highway Traffic Safety Administration, Department of Transportation.

<http://www-nrd.nhtsa.dot.gov/pdf/nrd-30/NCSA/Rpts/2002/809-403.pdf>

(This report has detailed tabulations of the extent of alcohol involvement from 1982 to 2000 using estimates generated with both the old and new methods. Alcohol Involvement is reported according to various categories of interest (age, sex, time of day, day of week, etc.)

Rubin, D.B., Schafer, J.L., and Subramanian, R. (1998) *Multiple Imputation of Missing Blood Alcohol Concentration (BAC) values in FARS*, Report DOT-HS-808-816, National Highway Traffic Safety Administration, Department of Transportation.

(This report presents an in-depth technical view of the Multiple Imputation process and its implementation in the FARS system. Detailed specifications of the statistical models used to estimate missing BACs are provided. Examples are also given of how the new data can be analyzed and used in models.)

[Return](#)

Ejection

NHTSA'S Ejection		
Classification (EJECTION)	Data Year and Element	
	1975 to 2006	2007 and later
Not Ejected	0	0, 8
Ejected	1, 2	1, 2, 3
Unknown	9	9, 7 (Not Reported, new in 2010)

[Return](#)

Person Type

Note: The early data has been modified to fit this format. For example, from 1975 to 1977 there was a value for fatal crashes involving a non-motorist in an animal drawn vehicle. This data has been reclassified into one of the values below.

NHTSA'S Person Type				
Classification (PER_TYP)	Data Year and Element			
	1975-1981	1982-1993	1994 to 2006	2007 and later
Motorists (Occupants)				
Driver	1	1	01	01
Passenger	2, 9	2, 9	02, 09	02, 09
Non-Motorists (Non-Occupants)				
Pedestrian	3	5	05	05
Pedalcyclist	4	6,7	06, 07	06, 07
Other non-occupant	5	3, 4	03, 04, 08	03, 04, 08, 10
Other/Unknown non-occupant	8	8	-	-
Unknown non-occupant type	-	-	19	19
Unknown				
Unknown	-	-	99 (1995-1996 only)	-

[Return](#)

Restraint System/Helmet Use

FARS Description	Data Year and Code					Classification
	1975-1990 (MAN_REST)	1991-1993 (REST_USE)	1994-2007 (REST_USE)	2008-2009 (REST_USE)	2010 (REST_USE)	
None used (vehicle occupant) or Not applicable (nonoccupant)	0	0	00	00	-	Not Used
Not Applicable – no restraint available in seat position of occupant (ex. sleeper cab or exterior)					00	
None Used – vehicle occupant					07	
Helmets used improperly	-	-	15	15	(5, 16) and *REST_MIS=1	
No helmet	-	-	-	-	17	
Shoulder belt	1	1	01	01	01	Used
Lap belt	2	2	02	02	02	
Lap and shoulder belt	3	3	03	03	03	
Child safety seat	4	4	04	-	-	
Child Safety/Booster Seat – Type Unknown/Not Reported	-	-	-	04	04	
Child Safety Seat – Forward Facing	-	-	-	10	10	
Child Safety Seat – Rear Facing	-	-	-	11	11	
Booster Seat (with lap/shoulder belt used properly)	-	-	-	12	12	
Motorcycle helmet	5	5	05	05	-	
DOT-Compliant motorcycle helmet					05 and *REST_MIS=0	
Other Helmet					16 and *REST_MIS=0	
Restraint used - type unknown or other including other helmet	8	8	08	08	08	

Restraint System/Helmet Use (continued)

FARS Description	Data Year and Code					Classification
	1975-1990 (MAN_REST)	1991-1993 (REST_USE)	1994-2007 (REST_USE)	2008-2009 (REST_USE)	2010 (REST_USE)	
Safety belt used improperly	-		13	13	-	
Child safety seat/booster seat used improperly	-		14	14	-	
Bicycle Helmet	-		06	06		
Other	-		-	-	97	
Unknown if used	9	9	99	99	99	Unknown
Not Reported					98	

* *Improperly used* helmets are classified as "Not Used." In 2010, the Restraint/Helmet Mis-Use (REST_MIS) element was introduced and "*Improperly Used*" attributes were removed from the Restraint Use (REST_USE) element.

Historically, *child safety seat used improperly* was classified as "Not Used" in FARS. In June of 2003, this attribute was re-classified as USED. All other *improperly used* restraint systems were placed in categories as appropriate.

The majority of restraint usage analysis focuses on 1) child safety seat or belt use for passenger vehicle occupants or; 2) helmet use for motorcyclists.

[Return](#)

Seating Position

Note: Starting in 2003 Person Level Forms are submitted for uninjured occupants of van-based buses.

1982-Later

Seating Position

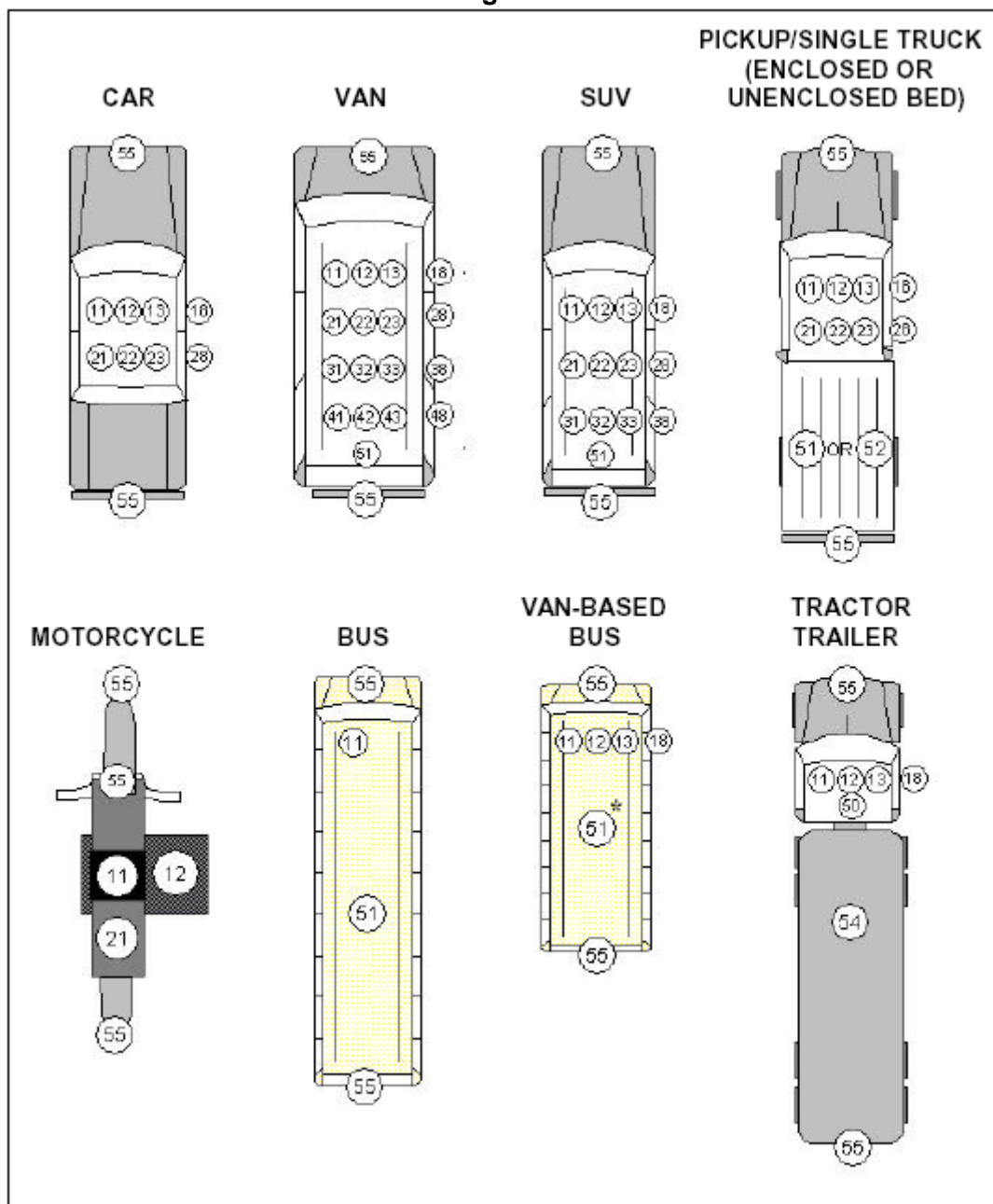

* For van-based buses, use the actual seating position if known, or use element 51 for the second, third, and fourth rows, if actual seating position is not known.

[Return](#)

**Appendix D:
FARS Variables by SAS Table and Year**

This is a note for the table/matrix below. This note applies to all three tables/matrices (i.e., the Accident file table/matrix, the Vehicle file table/matrix, and the Person file table/matrix).

The first row in which the letter “A” appears is the first year that variable was coded. If the letter “A” appears through the column there have been no significant changes in the way in which the variable has been coded. If the letter “B” appears in a column, there has been a significant change in the way the variable has been coded. The first row, which contains the letter “B,” indicates which year the first change was made. The letter “C” indicates the year the second change was made, and so on.

Accident Data Set

Year	ALIGNMNT	ARR_HOUR	ARR_MIN	CF1, CF2, CF3	CITY	CL_TWAY	COUNTY	C_M_ZONE	DAY	DAY_WEEK	DRUNK_DR	FATALS	FED_AID	HARM_EV	HIT_RUN
1975	A	A	A	A	A	A	A	-	A	A	A	A	-	A	A
1976	A	A	A	A	A	A	A	-	A	A	A	A	-	A	A
1977	A	A	A	A	A	A	A	-	A	A	A	A	-	A	B
1978	A	A	A	A	A	A	A	-	A	A	A	A	-	A	B
1979	A	A	A	A	A	A	A	-	A	A	A	A	-	A	B
1980	A	A	A	A	A	A	A	A	A	A	A	A	-	A	B
1981	A	A	A	A	A	-	A	A	A	A	A	A	-	A	B
1982	A	A	A	B	A	B	A	B	A	A	A	A	A	B	C
1983	A	A	A	B	A	B	A	B	A	A	A	A	A	B	C
1984	A	A	A	B	A	B	A	B	A	A	A	A	A	B	C
1985	A	A	A	B	A	B	A	B	A	A	A	A	A	B	C
1986	A	A	A	B	A	B	A	B	A	A	A	A	A	B	C
1987	A	A	A	B	A	-	A	B	A	A	A	A	B	B	C
1988	A	A	A	B	A	-	A	B	A	A	A	A	B	B	C
1989	A	A	A	B	A	-	A	B	A	A	A	A	B	B	C
1990	A	A	A	B	A	-	A	B	A	A	A	A	B	B	C
1991	A	A	A	B	A	-	A	B	A	A	A	A	B	B	C
1992	A	A	A	B	A	-	A	B	A	A	A	A	B	B	C
1993	A	A	A	B	A	-	A	B	A	A	A	A	B	C	C
1994	A	A	A	B	A	-	A	B	A	A	A	A	-	D	C
1995	A	A	A	B	A	-	A	B	A	A	A	A	-	D	C
1996	A	A	A	B	A	-	A	B	A	A	A	A	-	E	C
1997	A	A	A	B	A	-	A	B	A	A	A	A	-	F	C
1998	A	A	A	B	A	-	A	B	A	A	A	A	-	F	C
1999	A	B	B	C	A	-	A	B	A	A	A	A	-	F	C
2000	A	B	B	C	A	-	A	B	A	A	A	A	-	F	C
2001	A	B	B	C	A	-	A	B	A	A	A	A	-	F	C
2002	A	B	B	C	A	-	A	B	A	A	A	A	-	F	D
2003	A	B	B	C	A	-	A	B	A	A	A	A	-	F	E
2004	A	B	B	C	A	-	A	B	A	A	A	A	-	G	F
2005	A	B	B	C	A	-	A	B	A	A	A	A	-	H	F
2006	A	B	B	D	A	-	A	B	A	A	A	A	-	H	F
2007	A	B	B	D	A	-	A	B	A	A	A	A	-	H	F
2008	A	B	B	E	A	-	A	B	A	A	A	A	-	I	F
2009	A	C	C	E	A	-	A	-	A	A	A	A	-	I	-
2010															

Accident Data Set (continued)

Year	HOSP_HR	HOSP_MIN	HOUR	LAND_USE	LATTITUDE	LGT_COND	LONGITUD	MAN_COLL	MILEPT	MINUTE	MONTH	NHS	NOT HOUR	NOT_MIN	NO_LANES
1975	-	-	A	A	-	A	-	A	-	A	A	-	A	A	A
1976	-	-	A	A	-	A	-	A	-	A	A	-	A	A	A
1977	-	-	A	A	-	A	-	A	-	A	A	-	A	A	A
1978	-	-	A	A	-	A	-	B	-	A	A	-	A	A	A
1979	-	-	A	A	-	A	-	B	-	A	A	-	A	A	A
1980	-	-	A	A	-	B	-	B	-	A	A	-	A	A	B
1981	-	-	A	A	-	B	-	B	-	A	A	-	A	A	B
1982	-	-	A	A	-	B	-	B	A	A	A	-	A	A	B
1983	-	-	A	A	-	B	-	B	A	A	A	-	A	A	B
1984	-	-	A	A	-	B	-	B	A	A	A	-	A	A	B
1985	-	-	A	A	-	B	-	B	A	A	A	-	A	A	B
1986	-	-	A	A	-	B	-	B	A	A	A	-	A	A	B
1987	A	A	A	-	-	B	-	B	A	A	A	-	A	A	B
1988	A	A	A	-	-	B	-	B	A	A	A	-	A	A	B
1989	A	A	A	-	-	B	-	B	A	A	A	-	A	A	B
1990	A	A	A	-	-	B	-	B	A	A	A	-	A	A	B
1991	A	A	A	-	-	B	-	B	A	A	A	-	A	A	B
1992	A	A	A	-	-	B	-	B	A	A	A	-	A	A	B
1993	A	A	A	-	-	B	-	B	A	A	A	-	A	A	B
1994	A	A	A	-	-	B	-	B	A	A	A	A	A	A	B
1995	A	A	A	-	-	B	-	B	A	A	A	A	A	A	B
1996	A	A	A	-	-	B	-	B	A	A	A	A	A	A	B
1997	A	A	A	-	-	B	-	B	A	A	A	A	A	A	B
1998	A	A	A	-	-	B	-	B	A	A	A	A	A	A	B
1999	B	B	A	-	A	B	A	B	A	A	A	A	A	A	B
2000	B	B	A	-	A	B	A	B	A	A	A	A	A	A	B
2001	B	B	A	-	A	B	A	B	A	A	A	A	A	A	B
2002	B	B	A	-	A	B	A	C	A	A	A	A	A	A	B
2003	B	B	A	-	A	B	A	C	A	A	A	A	A	A	B
2004	B	B	A	-	A	B	A	C	A	A	A	A	A	A	B
2005	B	B	A	-	A	B	A	C	A	A	A	A	A	A	B
2006	B	B	A	-	A	B	A	C	A	A	A	A	A	A	B
2007	B	B	A	-	A	B	A	C	A	A	A	A	A	A	B
2008	B	B	A	-	A	B	A	C	A	A	B	A	A	A	B
2009	C	C	B	-	A	C	A	C	A	B	B	A	B	B	B
2010															

Accident Data Set (continued)

Year	PAVE_TYP	PEDS	PERSONS	PROFILE	RAIL	REL_JUNC	REL_ROAD	ROAD_FLO	ROAD_FNC	ROUTE	SCH_BUS	SP_JUR	SP_LIMIT	STATE	ST_CASE
1975	A	-	A	A	-	A	A	A	-	-	-	A	A	A	A
1976	A	-	A	A	-	A	A	A	-	-	-	B	A	A	A
1977	A	-	A	A	-	A	A	A	-	-	A	C	B	A	A
1978	A	-	A	A	-	A	A	A	-	-	A	C	B	A	A
1979	A	-	A	A	A	A	A	A	-	-	A	C	C	A	A
1980	A	-	A	A	A	A	A	A	-	-	A	C	D	A	A
1981	A	-	A	A	A	A	A	A	A	-	A	C	D	A	A
1982	A	-	B	B	A	A	A	-	A	-	A	C	D	A	A
1983	A	-	B	B	A	A	A	-	A	-	A	C	D	A	A
1984	A	-	B	B	A	A	A	-	A	-	A	C	D	A	A
1985	A	-	B	B	A	A	A	-	A	-	A	C	D	A	A
1986	A	-	B	B	A	A	A	-	A	-	A	C	D	A	A
1987	A	-	B	B	A	A	A	-	B	A	A	C	D	A	A
1988	A	-	B	B	A	A	A	-	B	A	A	C	D	A	A
1989	A	-	B	B	A	A	A	-	B	A	A	C	D	A	A
1990	A	-	B	B	A	A	A	-	B	A	A	C	D	A	A
1991	A	A	B	B	A	B	A	-	B	A	A	C	D	A	A
1992	A	A	B	B	A	B	A	-	B	A	A	C	D	A	A
1993	A	A	B	B	A	B	A	-	B	A	A	C	D	A	A
1994	A	A	B	B	A	B	A	-	B	A	A	C	D	A	A
1995	A	A	B	B	A	B	A	-	B	A	A	C	D	A	A
1996	A	A	B	B	A	B	A	-	B	A	A	C	D	A	A
1997	A	A	B	B	A	B	A	-	B	A	A	C	D	A	A
1998	A	A	B	B	A	B	B	-	B	A	A	C	D	A	A
1999	A	A	B	B	A	B	B	-	B	A	A	C	D	A	A
2000	A	A	B	B	A	B	B	-	B	A	A	C	D	A	A
2001	A	A	B	B	A	B	C	-	B	A	A	C	D	A	A
2002	A	A	B	B	A	B	C	-	B	A	A	C	D	A	A
2003	A	A	B	B	A	C	C	-	B	A	A	C	D	A	A
2004	A	A	B	B	A	C	C	-	B	A	A	C	D	B	A
2005	A	A	B	B	A	C	C	-	B	A	A	C	D	B	A
2006	A	A	B	B	A	C	C	-	B	A	A	C	D	B	A
2007	A	A	B	B	A	C	C	-	B	A	A	C	D	B	A
2008	A	A	B	B	A	C	C	-	B	A	A	C	D	B	A
2009	A	A	C	B	A	C	C	-	B	A	B	C	D	B	A
2010															

Accident Data Set (continued)

Year	SUR_COND	TA_1_CL	TRAF_FLO	TRA_CONT	TWAY_FLO	TWAY_ID	TWAY_ID2	T_CONT_F	VEHICLES	VE_FORMS	VE_TOTAL	WEATHER	WEATHER1, WEATHER2	WRK_ZONE	YEAR
1975	A	-	-	A	-	-	-	-	-	-	-	A	-	-	A
1976	A	-	-	A	-	-	-	-	A	A	-	A	-	-	A
1977	A	-	-	A	-	-	-	-	A	A	-	A	-	-	A
1978	A	A	-	A	-	-	-	-	A	A	-	A	-	-	A
1979	A	A	-	A	-	-	-	-	A	A	-	A	-	-	A
1980	A	A	-	A	-	-	-	-	A	A	-	B	-	-	A
1981	A	A	-	A	-	-	-	-	A	A	-	B	-	-	A
1982	A	-	-	B	A	A	-	A	-	B	-	C	-	-	A
1983	A	-	-	B	A	A	-	A	-	B	-	C	-	-	A
1984	A	-	-	B	A	A	-	A	-	B	-	C	-	-	A
1985	A	-	-	B	A	A	-	A	-	B	-	C	-	-	A
1986	A	-	-	B	A	A	-	A	-	B	-	C	-	-	A
1987	A	-	A	B	-	A	-	A	-	B	-	C	-	-	A
1988	A	-	A	B	-	A	-	A	-	B	-	C	-	-	A
1989	A	-	A	B	-	A	-	A	-	B	-	C	-	-	A
1990	A	-	A	B	-	A	-	A	-	B	-	C	-	-	A
1991	A	-	A	B	-	A	-	A	-	B	-	C	-	-	A
1992	A	-	A	B	-	A	-	A	-	B	-	C	-	-	A
1993	A	-	A	B	-	A	-	A	-	B	-	C	-	-	A
1994	A	-	A	B	-	A	-	A	-	B	-	C	-	-	A
1995	A	-	A	B	-	A	-	A	-	B	-	C	-	-	A
1996	A	-	A	B	-	A	-	A	-	B	-	C	-	-	A
1997	A	-	A	B	-	A	-	A	-	B	-	C	-	-	A
1998	A	-	A	B	-	B	-	A	-	B	-	C	-	-	B
1999	A	-	A	B	-	B	-	A	-	B	-	C	-	-	B
2000	A	-	A	B	-	B	-	A	-	B	-	C	-	-	B
2001	A	-	B	B	-	B	-	A	-	B	-	C	-	-	B
2002	A	-	B	C	-	B	-	A	-	B	-	C	-	-	B
2003	A	-	C	C	-	C	-	A	-	B	-	C	-	-	B
2004	A	-	C	C	-	C	C	A	-	B	-	C	-	-	B
2005	A	-	C	C	-	C	C	A	-	B	-	C	-	-	B
2006	A	-	C	C	-	C	C	A	-	B	A	C	-	-	B
2007	B	-	C	C	-	C	C	A	-	B	A	D	A	-	B
2008	B	-	C	C	-	C	C	A	-	B	A	D	A	-	B
2009	B	-	C	C	-	C	C	A	-	C	B	D	A	A	C
2010															

Vehicle Data Set

Year	AVOID	AXLES	BODY_TYP	BUS_USE	CARGO_BT	CDL_STAT	CHAS_TR	D_VISION1, D_VISION2 D, VISION3,	DEATHS	DEFORMED	DR_CF1, DR_CF2, DR_CF3,	DR_CF4	DR_DRINK	DR_HGT
1975	-	-	A	-	-	-	A	-	A	-	A	-	A	-
1976	-	-	A	-	-	-	A	-	A	-	A	-	A	-
1977	-	-	A	-	-	-	A	-	A	-	A	-	A	-
1978	-	-	A	-	-	-	A	-	A	A	B	-	A	-
1979	-	-	A	-	-	-	A	-	A	A	C	-	A	-
1980	-	-	A	-	-	-	A	-	A	A	C	-	A	-
1981	-	-	A	-	-	-	A	-	A	A	C	-	A	-
1982	-	-	B	-	-	-	-	-	A	A	D	-	A	-
1983	-	-	B	-	-	-	-	-	A	A	D	-	A	-
1984	-	-	B	-	-	-	-	-	A	A	D	-	A	-
1985	-	-	B	-	-	-	-	-	A	A	D	-	A	-
1986	-	-	B	-	-	-	-	-	A	A	E	-	A	-
1987	-	-	B	-	-	-	-	-	A	A	E	-	A	-
1988	-	-	B	-	-	-	-	-	A	A	E	-	A	-
1989	-	-	B	-	-	-	-	-	A	A	E	-	A	-
1990	-	-	B	-	-	-	-	-	A	A	E	-	A	-
1991	A	A	C	-	A	A	-	-	A	A	F	-	A	-
1992	A	A	C	-	A	A	-	-	A	A	F	-	A	-
1993	A	A	D	-	A	B	-	-	A	A	F	-	A	-
1994	A	A	D	-	A	B	-	-	A	A	G	-	A	-
1995	A	B	D	-	B	B	-	-	A	A	H	-	A	-
1996	A	B	D	-	B	B	-	-	A	A	H	-	A	-
1997	A	B	D	-	B	B	-	-	A	A	H	H	A	-
1998	A	B	D	-	B	B	-	-	A	A	H	H	A	A
1999	A	B	D	-	B	B	-	-	A	A	H	H	A	A
2000	A	B	D	-	B	B	-	-	A	A	I	I	A	A
2001	A	B	D	A	C	B	-	-	A	A	J	J	A	A
2002	A	B	D	A	C	B	-	-	A	A	K	K	A	B
2003	A	B	D	A	D	B	-	-	A	A	K	K	A	B
2004	A	B	D	A	D	B	-	-	A	A	L	L	A	B
2005	A	B	D	A	D	B	-	-	A	A	L	L	A	B
2006	A	B	D	A	D	B	-	-	A	A	L	L	A	B
2007	A	B	D	A	E	B	-	-	A	A	L	L	A	B
2008	A	-	D	A	E	B	-	-	A	A	M	M	A	B
2009	A	-	D	A	F	C	-	A	A	B	N	N	A	B
2010														

Vehicle Data Set (continued)

Year	DR_PRES	DR_TRAIN	DR_WGT	DR_ZIP	EMER_USE	FIRE_EXP	FIRST_MO	FIRST_YR	FLDCD_TR	GWVR	HARM_EV	HAZ_CARG	HAZ_INV	HAZ_PLAC	HAZ_ID
1975	A	A	-	-	-	A	A	A	A	-	A	-	-	-	-
1976	A	A	-	-	-	A	A	A	A	-	A	-	-	-	-
1977	B	A	-	-	A	A	A	A	A	-	A	-	-	-	-
1978	B	A	-	-	A	A	A	A	A	-	A	-	-	-	-
1979	B	A	-	-	A	A	A	A	A	-	A	-	-	-	-
1980	B	A	-	-	A	A	A	A	A	-	A	-	-	-	-
1981	B	A	-	-	A	A	A	A	A	-	A	-	-	-	-
1982	B	A	-	-	A	A	A	A	A	-	B	A	-	-	-
1983	B	A	-	-	A	A	A	A	A	-	B	A	-	-	-
1984	B	A	-	-	A	A	A	A	A	-	B	A	-	-	-
1985	B	A	-	-	A	A	A	A	A	-	B	A	-	-	-
1986	B	A	-	-	A	A	A	A	A	-	B	A	-	-	-
1987	B	-	-	A	A	A	A	A	A	-	B	A	-	-	-
1988	B	-	-	A	A	A	A	A	A	-	B	A	-	-	-
1989	B	-	-	A	A	A	A	A	A	-	B	A	-	-	-
1990	B	-	-	A	A	A	A	A	A	-	B	A	-	-	-
1991	B	-	-	A	A	A	A	A	A	-	B	B	-	-	-
1992	B	-	-	A	A	A	A	A	A	-	B	B	-	-	-
1993	B	-	-	A	A	A	A	A	A	-	C	B	-	-	-
1994	B	-	-	A	A	A	A	A	A	-	D	B	-	-	-
1995	B	-	-	A	A	A	A	A	A	-	D	B	-	-	-
1996	B	-	-	A	A	A	A	A	A	-	D	B	-	-	-
1997	B	-	-	A	A	A	A	A	A	-	E	B	-	-	-
1998	B	-	A	A	A	A	A	B	A	-	F	B	-	-	-
1999	B	-	A	A	A	A	A	B	A	-	F	B	-	-	-
2000	B	-	A	A	A	A	A	B	A	-	F	B	-	-	-
2001	B	-	A	A	A	A	A	B	A	A	F	B	-	-	-
2002	B	-	A	A	A	A	A	B	A	A	F	B	-	-	-
2003	B	-	A	A	A	A	A	B	A	A	F	B	-	-	-
2004	B	-	A	A	A	A	A	B	A	A	G	B	-	-	-
2005	B	-	A	A	A	A	A	B	A	A	H	B	-	-	-
2006	C	-	A	A	A	A	A	B	A	A	H	B	-	-	-
2007	C	-	A	A	A	A	A	B	A	A	H	-	A	A	A
2008	C	-	A	A	A	B	A	B	A	A	H	-	A	A	A
2009	D	-	A	A	B	C	A	B	A	A	H	-	A	A	A
2010															

Vehicle Data Set (continued)

Year	HAZ_CNO	HAZ_REL	HIT_RUN	IMPACT1	IMPACT2	IMPACTS	J_KNIFE	LAST_MO	LAST_YR	L_CL_VEH	L_COMPL	L_ENDORS	L_RESTRI	L_STATE	L_STATUS
1975	-	-	A	A	A	A	-	A	A	-	-	-	A	A	A
1976	-	-	A	A	A	A	-	A	A	-	-	-	A	A	A
1977	-	-	B	A	A	A	-	A	A	-	-	-	A	A	A
1978	-	-	B	A	A	A	-	A	A	-	-	-	A	A	A
1979	-	-	B	A	A	A	-	A	A	-	-	-	A	A	A
1980	-	-	B	A	A	A	A	A	A	-	-	-	A	A	A
1981	-	-	B	A	A	A	A	A	A	-	-	-	A	A	A
1982	-	-	C	A	A	A	B	A	A	A	-	-	A	A	B
1983	-	-	C	A	A	A	B	A	A	A	-	-	A	A	B
1984	-	-	C	A	A	A	B	A	A	A	-	-	A	A	B
1985	-	-	C	A	A	A	B	A	A	A	-	-	A	A	B
1986	-	-	C	A	A	A	B	A	A	A	-	-	A	A	B
1987	-	-	C	A	A	A	B	A	A	-	A	-	A	A	C
1988	-	-	C	A	A	A	B	A	A	-	A	-	A	A	C
1989	-	-	C	A	A	A	B	A	A	-	A	-	A	A	C
1990	-	-	C	A	A	A	B	A	A	-	A	-	A	A	C
1991	-	-	C	A	A	A	B	A	A	-	A	A	A	A	C
1992	-	-	C	A	A	A	B	A	A	-	A	A	A	A	C
1993	-	-	C	A	A	A	B	A	A	-	B	A	A	A	D
1994	-	-	C	B	B	A	B	A	A	-	B	A	A	A	D
1995	-	-	C	B	B	A	B	A	A	-	B	A	A	A	D
1996	-	-	C	B	B	A	B	A	A	-	B	A	A	A	D
1997	-	-	C	B	B	A	B	A	A	-	B	A	A	A	D
1998	-	-	C	B	B	A	B	A	B	-	B	A	A	A	D
1999	-	-	C	B	B	A	B	A	B	-	B	A	A	A	D
2000	-	-	C	B	B	A	B	A	B	-	B	A	A	A	D
2001	-	-	C	B	B	A	B	A	B	-	B	A	A	A	D
2002	-	-	D	B	B	A	B	A	B	-	B	A	A	A	D
2003	-	-	E	B	B	A	B	A	B	-	B	A	A	A	D
2004	-	-	F	C	C	A	B	A	B	-	B	A	A	A	E
2005	-	-	F	C	C	A	B	A	B	-	B	A	A	A	E
2006	-	-	F	C	C	A	B	A	B	-	B	A	A	A	E
2007	A	A	F	C	C	A	B	A	B	-	B	A	A	B	E
2008	B	A	F	C	C	A	B	A	B	-	B	A	A	B	E
2009	B	A	G	C	C	A	C	A	B	-	B	A	A	C	E
2010															

Vehicle Data Set (continued)

Year	L_TYPE	MAKE	MAK_MOD	MAN_COLL	MCARR_ID	MCYCL_DS	MCYCL_TY	MODEL	MOD_YEAR	MONTH	M_HARM	NUMOCCS	OCUPANTS	OWNER
1975	-	A	A	A	-	A	A	A	A	-	A	-	A	-
1976	-	A	A	A	-	A	A	A	A	-	A	-	A	-
1977	-	A	A	A	-	A	A	A	A	-	A	-	A	-
1978	-	A	A	B	-	A	A	A	A	-	A	-	A	-
1979	-	A	A	B	-	A	A	A	A	-	A	-	A	-
1980	-	A	A	B	-	A	A	A	A	-	A	-	A	-
1981	-	A	A	B	-	A	A	A	A	-	A	-	A	-
1982	-	B	B	B	-	A	-	B	A	-	B	-	A	-
1983	-	B	B	B	-	A	-	B	A	-	B	-	A	-
1984	-	B	B	B	-	A	-	B	A	-	B	-	A	-
1985	-	B	B	B	-	A	-	B	A	-	B	-	A	-
1986	-	B	B	B	-	A	-	B	A	-	B	-	A	-
1987	-	C	C	B	-	A	-	C	A	-	B	-	A	-
1988	-	C	C	B	-	A	-	C	A	-	B	-	A	-
1989	-	C	C	B	-	A	-	C	A	-	B	-	A	-
1990	-	D	C	B	-	A	-	C	A	-	B	-	A	-
1991	-	E	D	B	-	A	-	D	A	-	B	-	A	A
1992	-	E	D	B	-	A	-	D	A	-	B	-	A	A
1993	-	E	D	B	-	A	-	D	A	-	C	-	A	A
1994	-	E	D	B	-	A	-	D	A	-	D	-	A	A
1995	-	E	D	B	-	A	-	D	A	A	D	-	A	A
1996	-	E	D	B	-	A	-	D	A	A	D	-	A	A
1997	-	E	D	B	-	A	-	D	A	A	E	-	A	A
1998	-	E	D	B	A	A	-	D	B	A	F	-	A	A
1999	-	E	D	B	A	A	-	D	B	A	F	-	A	A
2000	-	E	D	B	A	A	-	D	B	A	F	-	A	A
2001	-	E	D	B	A	A	-	D	B	A	F	-	A	A
2002	-	E	D	C	A	A	-	D	B	A	F	-	A	A
2003	-	E	D	C	A	A	-	D	B	A	F	-	A	A
2004	A	E	D	C	A	A	-	D	B	A	G	-	A	A
2005	A	E	D	C	A	A	-	D	B	A	G	-	A	A
2006	A	E	D	C	A	A	-	D	B	A	G	-	A	A
2007	A	E	D	C	B	A	-	D	B	A	G	-	A	A
2008	A	E	D	C	B	A	-	D	B	A	H	-	A	A
2009	A	E	D	D	B	A	-	D	B	B	H	A	B	A
2010														

Vehicle Data Set (continued)

Year	PREV_ACC	PREV_DWI	PREV_OTH	PREV_SPD	PREV_SUS	REG_STAT	ROLINLOC	ROLLOVER	SEQ1, SEQ2, SEQ3, SEQ4, SEQ5, SEQ6	SER_TR	SPEC_USE	SPEEDREL	STATE	ST_CASE
1975	A	A	A	A	A	A	-	-	-	A	A	-	A	A
1976	A	A	A	A	A	A	-	-	-	A	A	-	A	A
1977	A	A	A	A	A	A	-	-	-	A	A	-	A	A
1978	A	A	A	A	A	A	-	A	-	A	A	-	A	A
1979	A	A	A	A	A	A	-	A	-	A	A	-	A	A
1980	A	A	A	A	A	A	-	A	-	A	A	-	A	A
1981	A	A	A	A	A	A	-	A	-	A	A	-	A	A
1982	A	A	A	A	A	A	-	A	-	A	A	-	A	A
1983	A	A	A	A	A	A	-	A	-	A	A	-	A	A
1984	A	A	A	A	A	A	-	A	-	A	A	-	A	A
1985	A	A	A	A	A	A	-	A	-	A	A	-	A	A
1986	A	A	A	A	A	A	-	A	-	A	A	-	A	A
1987	A	A	A	A	A	A	-	A	-	A	A	-	A	A
1988	A	A	A	A	A	A	-	A	-	A	A	-	A	A
1989	A	A	A	A	A	A	-	A	-	A	A	-	A	A
1990	A	A	A	A	A	A	-	A	-	A	A	-	A	A
1991	A	A	A	A	A	A	-	A	-	A	A	-	A	A
1992	A	A	A	A	A	A	-	A	-	A	A	-	A	A
1993	A	A	A	A	A	A	-	A	-	A	A	-	A	A
1994	B	B	B	B	B	A	-	A	-	A	A	-	A	A
1995	B	B	B	B	B	A	-	A	-	A	A	-	A	A
1996	B	B	B	B	B	A	-	A	-	A	A	-	A	A
1997	B	B	B	B	B	A	-	A	-	A	A	-	A	A
1998	B	B	B	B	B	A	-	A	-	A	A	-	A	A
1999	B	B	B	B	B	A	-	A	-	A	A	-	A	A
2000	B	B	B	B	B	A	-	A	-	A	A	-	A	A
2001	B	B	B	B	B	A	-	A	-	A	A	-	A	A
2002	B	B	B	B	B	A	-	A	-	A	A	-	A	A
2003	B	B	B	B	B	A	-	A	-	A	A	-	A	A
2004	B	B	B	B	B	A	-	A	A	A	A	-	A	A
2005	B	B	B	B	B	A	-	A	B	A	A	-	A	A
2006	B	B	B	B	B	A	-	A	B	A	A	-	A	A
2007	B	B	B	B	B	A	-	A	B	A	A	-	A	A
2008	B	B	B	B	B	B	-	A	C	A	A	-	A	A
2009	C	B	B	B	B	B	A	B	C	A	B	A	A	A
2010														

Vehicle Data Set (continued)

Year	TOWAWAY	TOWED	TOW_VEH	TRAV_SP	UNDERIDE	UNITTYPE	VEHICLES	VE_FORMS	VEH_CF1, VEH_CF2	VEH_MAN	VEH_NO	VIN	VINA_MOD	VIN_1, VIN_2, VIN_3, VIN_4, VIN_5, VIN_6, VIN_7, VIN_8, VIN_9, VIN_10
1975	A	-	A	A	-	-	-	-	A	-	A	A	A	A
1976	B	-	A	A	-	-	A	A	A	-	A	A	A	A
1977	B	-	A	A	-	-	A	A	A	-	A	A	A	A
1978	B	-	A	A	-	-	A	A	A	-	A	A	A	A
1979	B	-	A	A	-	-	A	A	A	-	A	A	A	A
1980	B	-	A	-	-	-	A	A	A	-	A	A	A	A
1981	B	-	A	-	-	-	A	A	A	-	A	A	A	A
1982	B	-	B	A	-	-	-	B	B	A	A	A	A	A
1983	B	-	C	A	-	-	-	B	B	A	A	A	A	A
1984	B	-	C	A	-	-	-	B	B	A	A	A	A	A
1985	B	-	C	A	-	-	-	B	B	A	A	A	A	A
1986	B	-	C	A	-	-	-	B	B	A	A	A	A	A
1987	B	-	C	A	-	-	-	B	B	A	A	A	A	A
1988	B	-	C	A	-	-	-	B	B	A	A	A	A	A
1989	B	-	C	A	-	-	-	B	B	A	A	A	A	A
1990	B	-	C	A	-	-	-	B	B	A	A	A	A	A
1991	B	-	C	A	-	-	-	B	B	A	A	A	A	A
1992	B	-	C	A	-	-	-	B	B	A	A	A	A	A
1993	B	-	C	A	-	-	-	B	B	A	A	A	A	A
1994	B	-	C	A	A	-	-	B	B	A	A	A	A	A
1995	B	-	C	A	A	-	-	B	B	A	A	A	A	A
1996	B	-	C	A	A	-	-	B	B	A	A	A	A	A
1997	B	-	C	A	A	-	-	B	B	A	A	A	A	A
1998	B	-	C	A	A	-	-	B	C	A	A	A	A	A
1999	B	-	C	A	A	-	-	B	D	A	A	A	A	A
2000	B	-	C	A	A	-	-	B	E	A	A	A	A	A
2001	B	-	C	A	A	-	-	B	F	A	A	A	A	A
2002	B	-	C	A	A	-	-	B	G	A	A	A	A	A
2003	B	-	C	A	A	-	-	B	G	A	A	A	A	A
2004	B	-	D	A	A	-	-	B	H	A	A	A	A	A
2005	B	-	D	A	A	A	-	B	I	A	A	A	A	A
2006	B	-	D	A	A	A	-	B	I	A	A	A	A	A
2007	B	-	D	A	A	A	-	B	J	A	A	A	A	A
2008	B	-	D	A	A	A	-	B	J	A	A	A	A	A
2009	-	A	E	B	A	A	-	C	K	A	B	B	A	B
2010														

Vehicle Data Set (continued)

Year	VIN_11, VIN_12	VIN_BT	VIN_LNGT	VIN_WGT	VIOL_CHG	VIOLCHG1, VIOLCHG2, VIOLCHG3	V_CONFIG	WGTCDD_TR	WHLBS_LG	WHLBS_SH
1975	-	-	A	A	A	-	-	A	A	A
1976	-	-	A	A	A	-	-	A	A	A
1977	-	-	A	A	A	-	-	A	A	A
1978	-	-	A	A	A	-	-	A	A	A
1979	-	-	A	A	A	-	-	A	A	A
1980	-	-	A	A	A	-	-	A	A	A
1981	-	-	A	A	A	-	-	A	A	A
1982	-	A	A	A	B	-	-	A	A	A
1983	-	A	A	A	B	-	-	A	A	A
1984	-	A	A	A	B	-	-	A	A	A
1985	-	A	A	A	B	-	-	A	A	A
1986	-	A	A	A	B	-	-	A	A	A
1987	-	A	A	A	B	-	-	A	A	A
1988	-	A	A	A	B	-	-	A	A	A
1989	-	A	A	A	B	-	-	A	A	A
1990	-	A	A	A	B	-	-	A	A	A
1991	-	A	A	A	B	-	A	A	A	A
1992	-	A	A	A	B	-	A	A	A	A
1993	-	A	A	A	B	-	A	A	A	A
1994	A	A	A	A	B	-	A	A	A	A
1995	A	A	A	A	B	-	B	A	A	A
1996	A	A	A	A	B	-	B	A	A	A
1997	A	A	A	A	-	A	B	A	A	A
1998	A	A	A	A	-	A	B	A	A	A
1999	A	A	A	A	-	A	B	A	A	A
2000	A	A	A	A	-	A	B	A	A	A
2001	A	A	A	A	-	A	C	A	A	A
2002	A	A	A	A	-	A	C	A	A	A
2003	A	A	A	A	-	A	C	A	A	A
2004	A	A	A	A	-	A	C	A	A	A
2005	A	A	A	A	-	A	C	A	A	A
2006	A	A	A	A	-	A	C	A	A	A
2007	A	A	A	A	-	A	C	A	A	A
2008	A	A	A	A	-	A	C	A	A	A
2009	B	A	A	A	B	B	C	A	A	A
2010										

Person Data Set

Year	AGE	AIR_BAG	ALC_DET	ACL_RES	ACL_STATUS	ATST_TYP	AUT_REST	BODY_TYP	CERT_NO	COUNTY	DAY	DEATH_DA	DEATH_HR
1975		-	-	-	-	-	A	A	-	A	A	A	A
1976		-	-	-	-	-	A	A	-	A	A	A	A
1977	A	-	-	-	-	-	B	A	-	A	A	A	A
1978	A	-	-	-	-	-	B	A	-	A	A	A	A
1979	A	-	-	-	-	-	B	A	-	A	A	A	A
1980	A	-	-	-	-	-	C	A	-	A	A	A	A
1981	A	-	-	-	-	-	C	A	-	A	A	A	A
1982	A	-	-	-	-	-	C	B	-	A	A	A	A
1983	A	-	-	-	-	-	C	B	-	A	A	A	A
1984	A	-	-	-	-	-	C	B	-	A	A	A	A
1985	A	-	-	-	-	-	C	B	-	A	A	A	A
1986	A	-	-	-	-	-	C	B	-	A	A	A	A
1987	A	-	A	-	-	-	C	B	-	A	A	A	A
1988	A	-	A	-	-	-	C	B	-	A	A	A	A
1989	A	-	A	-	-	-	C	B	-	A	A	A	A
1990	A	-	A	-	-	-	D	B	-	A	A	A	A
1991	A	A	A	A	-	-	-	C	A	A	A	A	A
1992	A	A	A	A	-	-	-	C	A	A	A	A	A
1993	A	A	A	A	-	-	-	D	A	A	A	A	A
1994	A	A	A	A	-	-	-	D	A	A	A	A	A
1995	A	A	A	B	-	-	-	D	A	A	A	A	A
1996	A	A	A	B	-	-	-	D	A	A	A	A	A
1997	A	A	A	B	-	-	-	D	A	A	A	A	A
1998	A	B	A	B	-	A	-	D	A	A	A	A	A
1999	A	B	A	B	-	A	-	D	A	A	A	A	A
2000	A	B	A	B	-	A	-	D	A	A	A	A	A
2001	A	B	A	B	-	B	-	D	A	A	A	A	A
2002	A	B	A	B	-	B	-	D	A	A	A	A	A
2003	A	B	B	B	-	B	-	D	A	A	A	A	A
2004	A	B	C	C	-	C	-	D	A	A	A	A	A
2005	A	B	C	C	-	C	-	D	A	A	A	A	A
2006	A	B	C	C	-	C	-	D	A	A	A	A	A
2007	A	B	C	C	-	C	-	D	A	A	A	A	A
2008	A	B	C	C	-	C	-	D	A	A	A	A	A
2009	B	C	C	C	A	D	-	D	A	A	B	B	B
2010													

Person Data Set (continued)

Year	DEATH_MN	DEATH_MO	DEATH_TM	DEATH_YR	DOA	DRINKING	DRUGRES1, DRUGRES2, DRUGRES3	DRUGS	DRUGTEST	DRUGTST1, DRUGTST2, DRUGTST3	DRUG_DET	DRUG_RES	DSTATUS
1975	A	A	A	A	-	A	-	-	-	-	-	-	-
1976	A	A	A	A	-	A	-	-	-	-	-	-	-
1977	A	A	A	A	-	A	-	-	-	-	-	-	-
1978	A	A	A	A	-	A	-	-	-	-	-	-	-
1979	A	A	A	A	-	A	-	-	-	-	-	-	-
1980	A	A	A	A	-	A	-	-	-	-	-	-	-
1981	A	A	A	A	-	A	-	-	-	-	-	-	-
1982	A	A	A	A	-	A	-	-	-	-	-	-	-
1983	A	A	A	A	-	A	-	-	-	-	-	-	-
1984	A	A	A	A	-	A	-	-	-	-	-	-	-
1985	A	A	A	A	-	A	-	-	-	-	-	-	-
1986	A	A	A	A	-	A	-	-	-	-	-	-	-
1987	A	A	A	A	-	A	-	-	-	-	-	-	-
1988	A	A	A	A	-	A	-	-	-	-	-	-	-
1989	A	A	A	A	-	A	-	-	-	-	-	-	-
1990	A	A	A	A	-	A	-	-	-	-	-	-	-
1991	A	A	A	A	-	A	-	A	A	-	A	A	-
1992	A	A	A	A	-	A	-	A	A	-	A	A	-
1993	A	A	A	A	-	A	A	A	-	A	A	-	-
1994	A	A	A	A	-	A	A	A	-	A	A	-	-
1995	A	A	A	A	-	A	A	A	-	A	A	-	-
1996	A	A	A	A	-	A	A	A	-	A	A	-	-
1997	A	A	A	A	-	A	A	A	-	A	A	-	-
1998	A	A	A	B	-	A	A	A	-	A	A	-	-
1999	A	A	A	B	-	A	A	A	-	A	A	-	-
2000	A	A	A	B	-	A	A	A	-	A	A	-	-
2001	A	A	A	B	A	A	A	A	-	A	A	-	-
2002	A	A	A	B	A	A	A	A	-	A	A	-	-
2003	A	A	A	B	A	A	A	A	-	A	A	-	-
2004	A	A	A	B	A	A	A	A	-	A	A	-	-
2005	A	A	A	B	A	A	A	A	-	A	A	-	-
2006	A	A	A	B	A	A	A	A	-	A	A	-	-
2007	A	A	A	B	A	A	A	A	-	A	A	-	-
2008	A	A	A	B	A	A	A	A	-	A	A	-	-
2009	B	B	B	C	A	A	A	B	-	A	A	-	A
2010													

Person Data Set (continued)

Year	EJECTION	EJ_PATH	EMER_USE	EXTRICAT	FIRE_EXP	HARM_EV	HISPANIC	HOSPITAL	HOUR	IMPACT1, IMPACT2	IMPACTS	INJ_SEV	LAG_HRS	LAG_MINS	LOCATION
1975	A	-	-	A	A	A	-	-	A	A	A	A	A	A	A
1976	A	-	-	A	A	A	-	-	A	A	A	A	A	A	A
1977	A	-	A	A	A	A	-	A	A	A	A	A	A	A	A
1978	A	-	A	A	A	A	-	A	A	A	A	A	A	A	A
1979	A	-	A	A	A	A	-	A	A	A	A	A	A	A	A
1980	A	-	A	A	A	A	-	A	A	A	A	A	A	A	A
1981	A	-	A	A	A	A	-	A	A	A	A	A	A	A	A
1982	A	-	A	A	A	B	-	A	A	A	A	A	A	A	B
1983	A	-	A	A	A	B	-	A	A	A	A	A	A	A	B
1984	A	-	A	A	A	B	-	A	A	A	A	A	A	A	B
1985	A	-	A	A	A	B	-	A	A	A	A	A	A	A	B
1986	A	-	A	A	A	B	-	A	A	A	A	A	A	A	B
1987	A	-	A	A	A	B	-	A	A	A	A	A	A	A	B
1988	A	-	A	A	A	B	-	A	A	A	A	A	A	A	B
1989	A	-	A	A	A	B	-	A	A	A	A	A	A	A	B
1990	A	-	A	A	A	B	-	A	A	A	A	A	A	A	B
1991	A	A	A	A	A	B	-	A	A	A	A	A	A	A	B
1992	A	A	A	A	A	B	-	A	A	A	A	A	A	A	B
1993	A	A	A	A	A	C	-	A	A	A	A	A	A	A	B
1994	A	A	A	A	A	D	-	A	A	B	A	A	A	A	B
1995	A	A	A	A	A	D	-	A	A	B	A	A	A	A	B
1996	A	A	A	A	A	D	-	A	A	B	A	A	A	A	B
1997	A	A	A	A	A	E	-	A	A	B	A	A	A	A	B
1998	A	A	A	A	A	F	-	A	A	B	A	A	A	A	B
1999	A	A	A	A	A	F	A	B	A	B	A	A	A	A	B
2000	A	A	A	A	A	F	B	B	A	B	A	A	A	A	B
2001	A	A	A	A	A	F	C	C	A	B	A	A	A	A	B
2002	A	A	A	A	A	F	C	C	A	B	A	A	A	A	B
2003	A	A	A	A	A	F	C	C	A	B	A	A	A	A	B
2004	A	A	A	A	A	G	C	C	A	B	A	A	A	A	B
2005	A	A	A	A	A	H	C	C	A	B	A	A	A	A	B
2006	A	A	A	A	A	H	C	C	A	B	A	A	A	A	C
2007	B	A	A	A	A	H	C	D	A	B	A	A	A	A	C
2008	C	A	A	A	A	H	C	D	A	B	A	A	A	A	C
2009	D	A	B	A	B	H	C	D	B	B	A	B	B	B	C
2010															

Person Data Set (continued)

Year	MAKE	MAK_MOD	MAN_COLL	MAN_REST	MCYCL_DS	MINUTE	MOD_YEAR	MONTH	N_MOT_NO	PER_NO	PER_TYP	P_CF1, P_CF2, P_CF3	RACE	REST_USE
1975	A	A	A	A	A	A	A	A	-	A	A	A	-	-
1976	A	A	A	A	A	A	A	A	-	A	A	B	-	-
1977	A	A	A	A	A	A	A	A	-	A	A	B	-	-
1978	A	A	B	A	A	A	A	A	-	A	A	B	-	-
1979	A	A	B	A	A	A	A	A	-	A	A	B	-	-
1980	A	A	B	A	A	A	A	A	-	A	A	B	-	-
1981	A	A	B	A	A	A	A	A	-	A	A	B	-	-
1982	B	B	B	A	A	A	A	A	A	A	B	C	-	-
1983	B	B	B	A	A	A	A	A	A	A	B	C	-	-
1984	B	B	B	A	A	A	A	A	A	A	B	C	-	-
1985	B	B	B	A	A	A	A	A	A	A	B	C	-	-
1986	B	B	B	A	A	A	A	A	A	A	B	C	-	-
1987	C	C	B	A	A	A	A	A	A	A	B	C	-	-
1988	C	C	B	A	A	A	A	A	A	A	B	C	-	-
1989	C	C	B	A	A	A	A	A	A	A	B	C	-	-
1990	D	C	B	A	A	A	A	A	A	A	B	C	-	-
1991	E	D	B	-	A	A	A	A	A	A	B	C	-	A
1992	E	D	B	-	A	A	A	A	A	A	B	C	-	A
1993	E	D	B	-	A	A	A	A	A	A	B	C	-	A
1994	E	D	B	-	A	A	A	A	A	A	C	C	-	B
1995	E	D	B	-	A	A	A	A	A	A	C	D	-	B
1996	E	D	B	-	A	A	A	A	A	A	C	D	-	B
1997	E	D	B	-	A	A	A	A	A	A	C	D	-	B
1998	E	D	B	-	A	A	B	A	A	A	C	D	-	B
1999	E	D	B	-	A	A	B	A	A	A	C	D	A	B
2000	E	D	B	-	A	A	B	A	A	A	C	E	B	B
2001	E	D	B	-	A	A	B	A	A	A	C	F	C	B
2002	E	D	C	-	A	A	B	A	A	A	C	G	C	B
2003	E	D	C	-	A	A	B	A	A	A	C	G	G	B
2004	E	D	C	-	A	A	B	A	A	A	C	G	G	B
2005	E	D	C	-	A	A	B	A	A	A	C	G	G	B
2006	E	D	C	-	A	A	B	A	A	A	C	G	G	B
2007	E	D	C	-	A	A	B	A	A	A	D	H	G	B
2008	E	D	C	-	A	A	B	A	A	A	D	I	G	C
2009	E	D	D	-	A	B	B	B	B	B	D	I	G	C
2010														

Person Data Set (continued)

Year	ROAD_FNC	ROLLOVER	SCH_BUS	SEAT_POS	SER_TR	SEX	SPEC_USE	STATE	ST_CASE	TEST_RES	TOW_VEH	TOXCLGY	VEH_NO	VE_FORMS	VINA_MOD
1975	-	-	-	A	A	A	A	A	A	A	-	-	A	-	A
1976	-	-	-	A	A	A	A	A	A	A	-	-	A	A	A
1977	-	-	A	A	A	A	A	A	A	A	A	-	A	A	A
1978	-	A	A	A	A	A	A	A	A	A	A	-	A	A	A
1979	-	A	A	A	A	A	A	A	A	A	A	-	A	A	A
1980	-	A	A	A	A	A	A	A	A	A	B	-	A	A	A
1981	A	A	A	A	A	A	A	A	A	A	B	-	A	A	A
1982	A	A	A	B	A	A	A	A	A	A	C	-	A	B	A
1983	A	A	A	B	A	A	A	A	A	A	C	-	A	B	A
1984	A	A	A	B	A	A	A	A	A	A	C	-	A	B	A
1985	A	A	A	B	A	A	A	A	A	A	C	-	A	B	A
1986	A	A	A	B	A	A	A	A	A	A	C	-	A	B	A
1987	B	A	A	B	A	A	A	A	A	A	C	A	A	B	A
1988	B	A	A	B	A	A	A	A	A	A	C	A	A	B	A
1989	B	A	A	B	A	A	A	A	A	A	C	A	A	B	A
1990	B	A	A	B	A	A	A	A	A	A	C	A	A	B	A
1991	B	A	A	B	A	A	A	A	A	-	C	-	A	B	A
1992	B	A	A	B	A	A	A	A	A	-	C	-	A	B	A
1993	B	A	A	B	A	A	A	A	A	-	C	-	A	B	A
1994	B	A	A	B	A	A	A	A	A	-	C	-	A	B	A
1995	B	A	A	B	A	A	A	A	A	-	C	-	A	B	A
1996	B	A	A	B	A	A	A	A	A	-	C	-	A	B	A
1997	B	A	A	B	A	A	A	A	A	-	C	-	A	B	A
1998	B	A	A	B	A	A	A	A	A	-	C	-	A	B	A
1999	B	A	A	B	A	A	A	A	A	-	C	-	A	B	A
2000	B	A	A	B	A	A	A	A	A	-	C	-	A	B	A
2001	B	A	A	B	A	A	A	A	A	-	C	-	A	B	A
2002	B	A	A	B	A	A	A	A	A	-	C	-	A	B	A
2003	B	A	A	B	A	A	A	A	A	-	C	-	A	B	A
2004	B	A	A	B	A	A	A	A	A	-	C	-	A	B	A
2005	B	A	A	B	A	A	A	A	A	-	C	-	A	B	A
2006	B	A	A	B	A	A	A	A	A	-	C	-	A	B	A
2007	B	A	A	B	A	A	A	A	A	-	C	-	A	B	A
2008	B	A	A	B	A	A	A	A	A	-	C	-	A	B	A
2009	B	B	B	C	A	A	B	A	A	-	E	-	B	C	A
2010															

Person Data Set (continued)

Year	VIN_BT	VIN_WGT	WGTC_D_TR	WHLBS_LG	WHLBS_SH	WORK_INJ
1975	-	A	A	A	A	-
1976	-	A	A	A	A	-
1977	-	A	A	A	A	-
1978	-	A	A	A	A	-
1979	-	A	A	A	A	-
1980	-	A	A	A	A	-
1981	-	A	A	A	A	-
1982	A	A	A	A	A	-
1983	A	A	A	A	A	-
1984	A	A	A	A	A	-
1985	A	A	A	A	A	-
1986	A	A	A	A	A	-
1987	A	A	A	A	A	A
1988	A	A	A	A	A	A
1989	A	A	A	A	A	A
1990	A	A	A	A	A	A
1991	A	A	A	A	A	A
1992	A	A	A	A	A	A
1993	A	A	A	A	A	A
1994	A	A	A	A	A	A
1995	A	A	A	A	A	A
1996	A	A	A	A	A	A
1997	A	A	A	A	A	A
1998	A	A	A	A	A	A
1999	A	A	A	A	A	A
2000	A	A	A	A	A	A
2001	A	A	A	A	A	A
2002	A	A	A	A	A	A
2003	A	A	A	A	A	A
2004	A	A	A	A	A	A
2005	A	A	A	A	A	A
2006	A	A	A	A	A	A
2007	A	A	A	A	A	A
2008	A	A	A	A	A	A
2009	A	A	A	A	A	A
2010						